



MOTO

2026

NEO
TOOLS

GRAPHITE



NEO TOOLS

25
years
GUARANTEE



*

* 25 lat Gwarancji oraz certyfikat TÜV M + T (Monitoring + Testing) posiadają wybrane produkty NEO TOOLS – szczegóły na stronie neo-tools.com
Selected NEO TOOLS products feature a 25-year warranty and a TÜV M + T (Monitoring + Testing) certificate – you can find details at neo-tools.com
Некоторые товары NEO TOOLS имеют 25-летнюю гарантию и сертификат TÜV M + T (Monitoring + Testing) – подробная информация доступна на сайте neo-tools.com

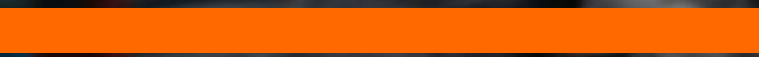

SPIS TREŚCI

CONTENTS

ЗМІСТ

WYPOSAŻENIE WARSZTATU / WORKSHOP EQUIPMENT / ОБЛАДНАННЯ МАЙСТЕРНІ

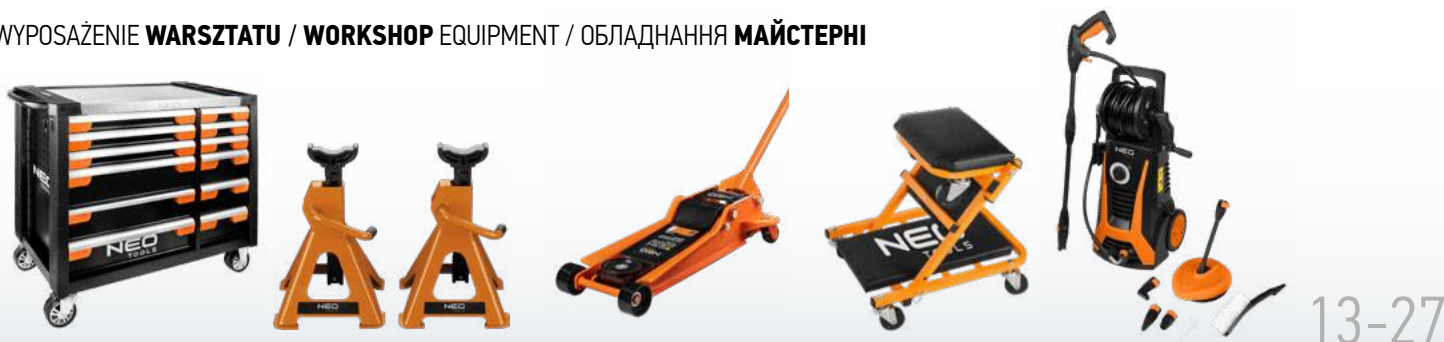

13-27

NARZĘDZIA RĘCZNE MECHANICZNE / MECHANICAL HAND TOOLS / МЕХАНІЧНІ РУЧНІ ІНСТРУМЕНТИ



29-92

NARZĘDZIA SPECJALISTYCZNE / SPECIALIZED TOOLS / СПЕЦІАЛІЗОВАНІ ІНСТРУМЕНТИ



94-133

NORMALIA WARSZTATOWE / WORKSHOP STANDARD ITEMS / СТАНДАРТНІ ПРЕДМЕТИ МАЙСТЕРНІ



135-140

CHEMIA MOTORYZACYJNA / AUTOMOTIVE CHEMICALS / АВТОМОБІЛЬНА ХІМІЯ



142



144-149



151-165



167-174



176-186



188-218



220-244



NEO TOOLS to...

Wysokiej klasy narzędzia ręczne, elektronarzędzia i akcesoria dla profesjonalistów i wymagających użytkowników

NEO TOOLS is...

High-quality hand tools, power tools, and accessories for professionals and demanding users

NEO TOOLS це...

Високоякісні ручні інструменти, електроінструменти та аксесуари для професіоналів і вимогливих користувачів

**Zapraszamy na kanały marki NEO TOOLS
w mediach społecznościowych**

**Come and browse NEO TOOLS social media
channels**

**Запрошуємо на канали марки NEO TOOLS
у соціальних мережах**



@NEOTOOLS



@NEOTOOLSOFFICIAL



Informacje o nowościach produktowych, wydarzeniach, konkursy, porady oraz video

Information about novelities, events, competitions, tips and videos

Інформація про нові продукти, події, конкурси, поради та відео





JAKOŚĆ

Najwyższa jakość materiałów i najnowocześniejsze rozwiązania technologiczne to kluczowe założenia standardów jakości NEO TOOLS. Narzędzia NEO TOOLS to ergonomiczne, precyzyjnie wykonane narzędzia stworzone do pracy w najcięższych warunkach. Produkty NEO TOOLS testowane są zarówno w specjalistycznych laboratoriach jak i w miejscach pracy profesjonalistów.

QUALITY

High quality of materials and well proven technical solutions are the key foundations of the NEO TOOLS quality standards. High quality and precision of workmanship make the NEO TOOLS tools fit for use in the harshest conditions. NEO TOOLS products are tested in specialised laboratories as well as in professionals' workplaces.

КАЧЕСТВО

Высокое качество материалов и проверенные технические решения являются ключевыми принципами стандартов качества NEO TOOLS. Благодаря высокому качеству и точности исполнения инструменты NEO TOOLS отлично проявляют себя в сложнейших рабочих условиях. Продукты NEO TOOLS тестируются как в специализированных лабораториях, так и на местах работы профессионалов.

Laboratorium NEO TOOLS

Narzędzia NEO TOOLS poddawane są specjalistycznym i rygorystycznym testom wytrzymałościowym. Badania jakościowe oparte są o normy europejskie. System zarządzania jakością w Dziale Technicznym posiada certyfikat zgodności z jedną z najważniejszych norm dotyczących kontroli jakości ISO 9001:2015

NEO TOOLS laboratory

NEO TOOLS undergo specialised and rigorous strength testing. Quality testing is based on European standards. The quality management system of the Technical Department is certified for compliance with one of the most important standards in the quality control field: ISO 9001:2015.

Лаборатория NEO TOOLS

Инструменты NEO TOOLS подвергаются строгому специализированному тестированию на прочность. Проверка качества выполняется согласно европейским нормам. Система управления качеством в техническом отделе имеет сертификат соответствия одной из важнейших норм, касающихся контроля качества ISO 9001:2015





25
years
GUARANTEE*

W procesie produkcji wykorzystywane są starannie wyselekcjonowane materiały, a jakość narzędzi jest stale weryfikowana w trakcie rygorystycznych procedur kontrolnych. Produkty NEO TOOLS spełniają najwyższe kryteria jakościowe, czego znakiem jest 25-letni okres ochrony gwarancyjnej na narzędzia mechaniczne NEO TOOLS.

Manufacturing process uses carefully selected materials, and the tool quality is constantly verified with rigorous control procedures. NEO TOOLS products meet the highest quality criteria, which is confirmed with 25 years warranty for NEO TOOLS mechanical tools.

В процессе производства используются старательно отобранные материалы, а качество инструментов постоянно верифицируется в ходе строгих контрольных процедур. Продукты NEO TOOLS отвечают наивысшим критериям качества, что подтверждает 25-летняя гарантия на механические инструменты NEO TOOLS.

Narzędzia NEO TOOLS cieszą się zaufaniem wymagających użytkowników oraz profesjonalistów, którzy poszukują rozwiązań na najwyższym poziomie. O niezawodności i uznaniu ze strony środowiska biznesowego świadczą liczne wyróżnienia. Najważniejszym z nich jest międzynarodowy certyfikat TÜV, który jest jednym z najbardziej rozpoznawalnych znaków jakości na świecie.

NEO TOOLS earned trust of demanding users and professionals who search for solutions of the highest standards. Reliability and recognition in the business sector are confirmed with numerous prizes and distinctions. The most important of all is the international TÜV certificate, one of the most recognised quality marks in the world.

Инструменты NEO TOOLS пользуются доверием требовательных пользователей и профессионалов, ищущих решений на наивысшем уровне. О надежности и признании со стороны профессионального сообщества свидетельствуют многочисленные знаки отличия. Важнейший из них - международный сертификат TÜV, являющийся одним из наиболее узнаваемых знаков качества в мире.



NEO GARAGE

GARAŻ GARAGE ГАРАЖ

NEO Garage oferuje rozbudowaną i dopasowaną do potrzeb użytkowników ofertę garażowania różnego typu pojazdów

NEO Garage offers an extensive and tailor-made offer for garaging various types of vehicles.

NEO Garage пропонує широку та індивідуальну пропозицію для зберігання різних типів транспортних засобів



SKLEP Z NARZĘDZIAMI I BHP NEO TOOLS

TOOL AND HEALTH AND SAFETY SHOP
NEO TOOLS

МАГАЗИН ІНСТРУМЕНТІВ ТА ЗАСОБІВ
ОХОРОНИ ПРАЦІ NEO TOOLS



EVENTY EVENTS ПОДІЇ

Dysponujemy przestrzenią 1000-1500 m² do zagospodarowania na potrzeby eventowe

We have 1,000-1500 m² of space available for event use.

Маємо простір 1000-1500 m² для проведення заходів



STANOWISKA SAMOBSŁUGOWE SELF SERVICE STATIONS СТАНЦІЇ САМООБСЛУГОВУВАННЯ

Możliwość samodzielnej naprawy i konserwacji pojazdów. Udostępniamy niezbędne narzędzia oraz myjnie i stanowiska do auto-detailingu.

Possibility to repair and maintain vehicles yourself. We provide the necessary tools as well as a car wash and auto-detailing stands.

Можливість самостійно ремонтувати та обслуговувати транспортні засоби. Ми надаємо необхідні інструменти, а також автомийки та стенди для автосервісу.

GRAPHITE to:

- szeroki asortyment wysokiej jakości elektronarzędzi i akcesoriów
- ważny i wiodący element marki stanowi system Energy+
- elektronarzędzia przeznaczone do intensywnego użytkowania, przy obciążeniach bliskich profesjonalnym
- produkty z optymalnym zestawem cech: wytrzymałe, ergonomiczne, o mocnych silnikach

GRAPHITE is:

- a wide range of high quality power tools and accessories
- an important and leading element of the brand is the Energy+ System
- power tools designed for intensive semi-professional use
- products with optimum set of features: durable, ergonomic, with powerful motors

GRAPHITE це:

- широкий асортимент високоякісного електроінструменту та аксесуарів до нього
- важливим та провідним елементом бренду є система Energy +
- електроінструмент, призначений для інтенсивного використання при навантаженнях, наближених до професійних
- продукти з оптимальним набором якостей: міцні, з потужними двигунами та ергономічною конструкцією



Zapraszamy na kanały marki GRAPHITE w mediach społecznościowych

Come and browse GRAPHITE social media channels

Запрошуємо на канали марки GRAPHITE у соціальних мережах



GRAPHITE

Informacje o nowościach produktowych, porady oraz VIDEO



Information on new products, advice and VIDEOS

Інформація про нові продукти, події, поради та відео

Elektronarzędzia NEO TOOLS i GRAPHITE

NEO TOOLS i GRAPHITE powertools

Електроінструменти NEO TOOLS i GRAPHITE

3
YEARS
WARRANTY



Marki **NEO TOOLS** i **GRAPHITE** zapewniają pełną dostępność części zamiennych oraz materiałów eksploatacyjnych dla elektronarzędzi. Dzięki temu elektronarzędzia mogą być sprawne przez długi czas.

NEO TOOLS and **GRAPHITE** brands ensure full availability of spare parts for power tools. This allows power tools to remain operational for a long time.

Марки **NEO TOOLS** та **GRAPHITE** забезпечують повну доступність запасних частин та витратних матеріалів для електроінструментів. Завдяки цьому електроінструменти можуть довго залишатися справними.



TESTOWANIE NARZĘDZI

Narzędzia mechaniczne i warsztatowe marki NEO TOOLS są testowane nie tylko laboratoryjnie, ale przede wszystkim w realnych warunkach pracy. Nasze narzędzia zanim wejdą na rynek używane są w profesjonalnym warsztacie mechanicznym NEO Garage.

Dzięki temu możemy zaoferować Państwu najwyższej jakości produkty przeznaczone do pracy w branży motoryzacyjnej.



TOOL TESTING

NEO TOOLS brand mechanical and workshop tools are tested not only in the laboratory, but also in real working conditions. Before they enter the market, our tools are used in the professional mechanical workshop NEO Garage.

This allows us to offer you the highest quality products for automotive work.

ВИПРОБУВАННЯ ІНСТРУМЕНТУ

Механічний та слюсарний інструмент торгової марки NEO TOOLS тестується не тільки в лабораторії, але, перш за все, в реальних робочих умовах. Наші інструменти перед виходом на ринок проходять випробування в професійній механічній майстерні NEO Garage.

Завдяки цьому ми можемо запропонувати Вам продукцію найвищої якості для автомобільних робіт.

NEO GARAGE



WYPOSAŻENIE WARSZTATU

workshop equipment обладнання майстерні



Szafka narzędziowa

Tool cabinet / Werkzeugschrank / Шкафчик для инструментов / Шафа інструментальна / Műhelykocsi / Dulap pentru scule / Skříňka na nářadí / Skrinka na náradie / Omaraica za orodje / Įrankių spintelė / Instrumentu skapis / Тööriistakapp / Шкафче за инструменти / Ormar za alate / Ormaric za alatke / Ντουλαπάκι για εργαλεία / Armario de almacenaje para herramientas / Carrello porta utensili / Estante p. Ferramentas / Rmoire à outils / Gereedschapskast

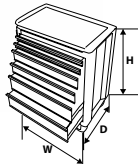

Ref.	D [mm]	W [mm]	H [mm]	capacity [kg]	☒	EAN
84-214	460	680	825	280	0/1	5907558426373

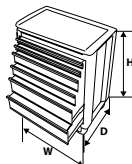
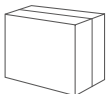

Ref.	D [mm]	W [mm]	H [mm]	capacity [kg]	☒	EAN
84-221	460	680	1030	280	0/1	5907558422238

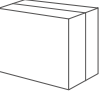
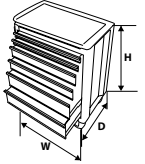

Ref.	D [mm]	W [mm]	H [mm]	capacity [kg]	☒	EAN
84-225	465	1105	978	600	0/1	5907558422269

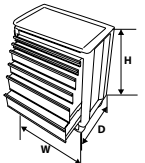

Ref.	D [mm]	W [mm]	H [mm]	capacity [kg]	☒	EAN
84-220	460	810	980	300	0/1	5907558418293

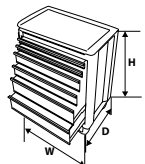
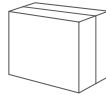

Ref.	D [mm]	W [mm]	H [mm]	capacity [kg]	☒	EAN
84-222	460	680	1030	280	0/1	5907558422245

Wózek warsztatowy

Workshop trolley / Werkstatttrollwagen / Тележка для инструмента / Візок інструментальний / Műhely kocs / Cărucior de atelier / Dílenský vozík / Dielenský vozík / Delavniški voziček / Vežimēlis dirbtuvēms / Instrumentu ratiņi / Töökajätkäru / Работна колица / Kolica za radionicu / Radionička kolica / Καρότσι εργαλείων / Carrito de taller / Carrello portautensili / Carrinho de oficina / Chariot d'atelier / Werkplaatskar

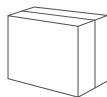

Kompatybilne z wkładkami narzędziowymi NEO
Compatible with NEO tool inserts
Совместимость с инструментальными вставками NEO

Ref.	D [mm]	W [mm]	H [mm]	capacity [kg]	☒	EAN
84-229	390	630	810	130	0/1	5907558435610

Uchwyt na papier

Paper sheet holder / Papierhalter / Держатель для бумаги / Тримач для паперу / Papírtartó / Suport pentru hârtie / Držák na papír / Držak na papier / Držalo za papir / Popieriaus laikiklis / Papīra turētājs / Paberihoidik / Поставка за хартия / Držac za papir / Držac za papir / Βάση χαρτίου / Portapapeles / Portacarta / Suporte de papel / Poignée pour papier



1mm COLD STEEL
ADAPTER INCLUDED

Ref.	☒	EAN
84-271	0/10	5907558481617

Półka na elektronarzędzia akumulatorowe

Shelf for cordless power tools / Ablage für schnurlose Elektrowerkzeuge / Полка для аккумуляторных инструментов / Поллица для аккумуляторних електроінструментів / Polc vezeték nélküli elektromos szerszámok számára / Raft pentru unelte electrice fără fir / Police na akumulátorové elektrické náradie / Polica na akumulátorové elektrické náradie / Polica za akumulatorsko električno orodje / Lentyna akumulatoriniams elektriniams įrankiams / Plaukts bezvada elektriskajiem instrumentiem / Riitul akutiööriistade jaoks / Рафт за акумулаторни електроинструменти / Polica za bežične električne alate / Поллица за акумулаторске електричне алате / Ράφι για εργαλεία μπαταρίας / Estante para herramientas eléctricas inalámbricas / Ripiano per utensili elettrici a batteria / Prateleira para ferramentas eléctricas sem fios / Etagère pour les outils électriques sans fil / Legplank voor draadloos elektrisch gereedschap



75kg capacity



Ref.	D [mm]	W [mm]	H [mm]	capacity [kg]	☒	EAN
84-404	420	660	835	75	0/1	5907558471625

Kosz na śmieci

Dust bin / Papierkorb / Корзина для мусора / Смітник / Szemétkosár / Coş de gunoi / Odpadkový koš / Smetny koš / Koş za smeti / Šlukšilių dėžė / Atkritumu grozis / Prügikorv / Кош за отпадъци / Košarica za smeće / Καλάθι ακουπιδιών / Cubo de basura / Cestino della spazzatura / Caixaote de lixo / Poubelle



1mm COLD STEEL

5.5L

250x68x250mm

Ref.	☒	EAN
84-274	0/4	5907558481624

Haki

Hooks / Hacken / Крючки / Гаки / Horgok / Cárilige / Háky / Skoby / Kijuke / Kabliai / Āķi / Haagid / Кюки / Kuke / Kuke / Γάντζοι / Ganchos / Ganci / Anzais / Crochets / Haken



x3

40 mm

for
84-500
84-501



Ref.	L [mm]	☒	EAN
84-096	40	0/65	5907558439267



x5

85 mm

for
84-500
84-501



Ref.	L [mm]	☒	EAN
84-097	85	0/50	5907558439274



x5

40 mm

for
84-500
84-501



Ref.	L [mm]	☒	EAN
84-095	40	0/100	5907558439250



for
84-500
84-501



Ref.	☒	EAN
84-092	8/40	5907558439151

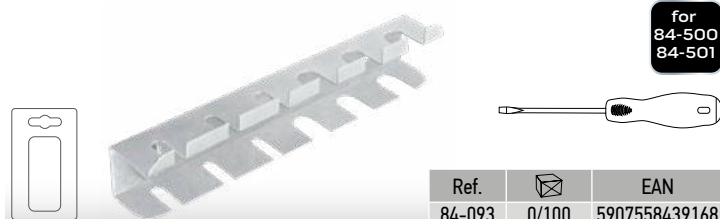

for
84-500
84-501

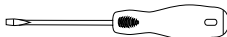

Ref.	☒	EAN
84-093	0/100	5907558439168

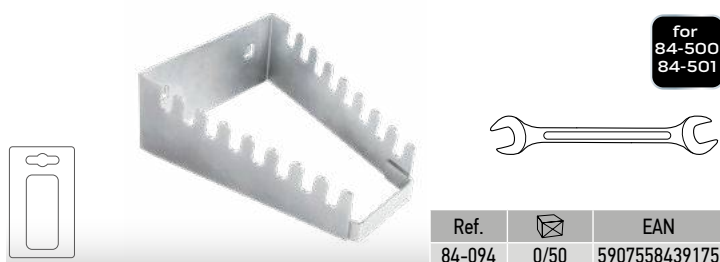

for
84-500
84-501



Ref.	☒	EAN
84-094	0/50	5907558439175



for
84-500
84-501

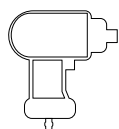

Ref.	☒	EAN
84-098	0/100	5907558442526

Skrzynka narzędziowa

Tool box / Werkzeugkasten / Ящик для инструмента / Скриня инструментальна / Szerszámtábla / Cutie scule / Náradová skříňka / Baza na náradie / Škatla za orodje / Įrankių dėžė / Instrumentu koferis / Tööriistakast / Кюфар за инструменти / Kutija za alat / Kutija za alat / Εργαλειοθήκη / Caja de herramientas / Valigetta elettricista modulare / Caixa p. ferramentas / Caisse à outils / Gereedschapskist

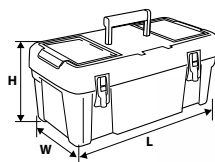

Ref.	L [mm]	W [mm]	H [mm]	☒	EAN
84-102	460	240	255	0/1	5907558409574
84-105	545	280	270	0/1	5907558408683

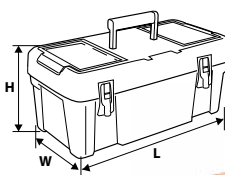

Ref.	L [mm]	W [mm]	H [mm]	☒	EAN
84-114	495	360	710	0/1	5907558439182

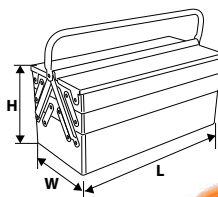

STEEL

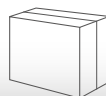

Ref.	L [mm]	W [mm]	H [mm]	m [kg]	☒	EAN
84-100	460	220	210	4,3	1/1	5907558409437
84-101	550	220	210	5	1/1	5907558409444

System modułowy I

Modular system / Modulares System / Модульная система / Модульна система / Moduláris rendszer / Sistem modular / Modulární systém / Modulový systém / Modularni sistem / Moduline sistema / Modulu sistema / Modulaarne süsteem / Модулна система / Modularni sustav / Модуларни систем / Αρθρωτό σύστημα / Sistema modular / Sistema modulare / Sistema modular / Système modulaire / Modulair systeem



Ref.	L[mm]	W[mm]	H[mm]	☒	EAN
84-256	585	385	322	0/1	5907558431643

Ref.	L[mm]	W[mm]	H[mm]	☒	EAN
84-257	585	385	422	0/1	5907558431650



Ref.	L[mm]	W[mm]	H[mm]	☒	EAN
84-255	585	385	190	0/1	5907558431636

Ref.	L[mm]	W[mm]	H[mm]	☒	EAN
84-266	585	460	765	0/1	5907558433968



Ref.	L[mm]	W[mm]	H[mm]	☒	EAN
84-268	585	385	131	0/1	5907558443585

Ref.	L[mm]	W[mm]	H[mm]	☒	EAN
84-350	448	322	126	0/1	5907558459708

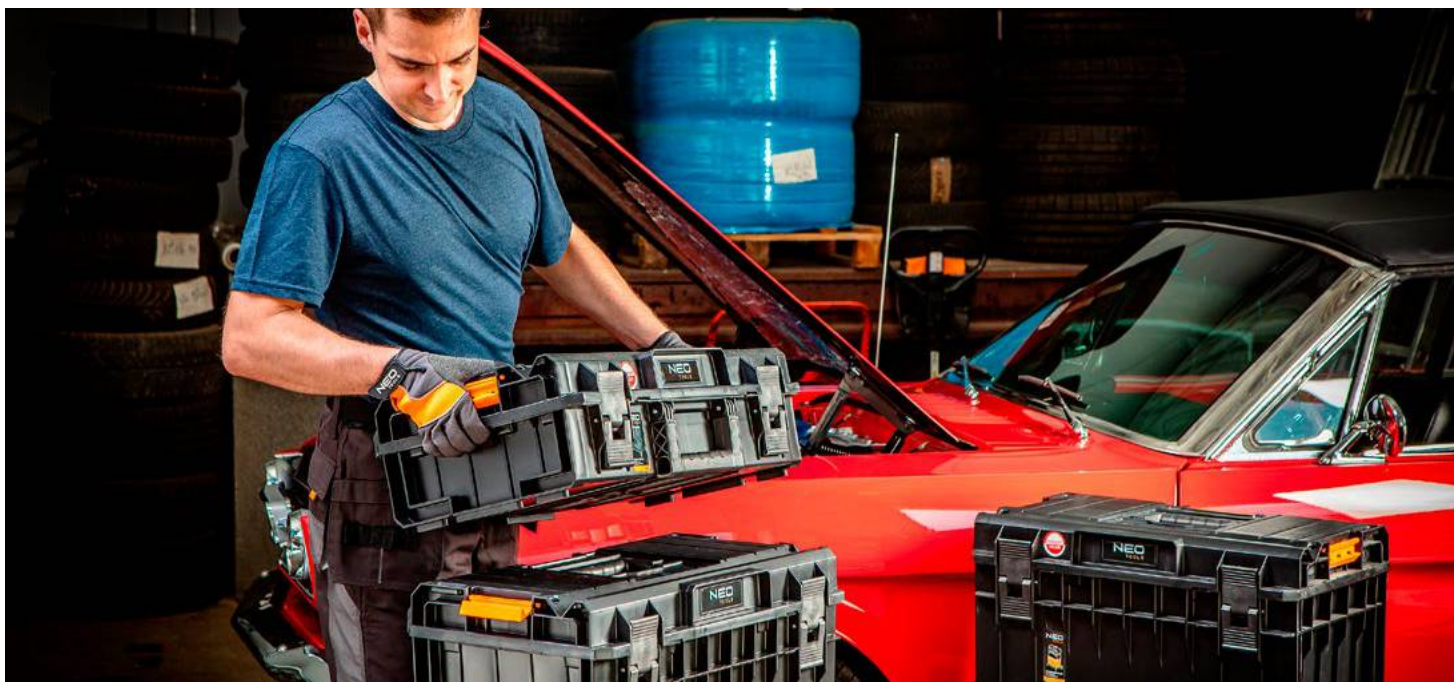

Warsztat mobilny

Mobile workshop / Werkzeugkasten / Мобильная мастерская / Скриня інструментальна / Szerszámkocsi / Cutie scule / Nářadová skříňka / Baza na náradie / Skatla za orodje / Įrankių dėžė / Instrumentu koferis / Tööriistakast / Купфар за инструменти / Kutija za alat / Kutija za alat / Εργαλειοθήκη / Caja de herramientas / Carrello porta utensili / Caixa p. ferramentas / Caisse à outils / Gereedschapskist

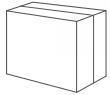
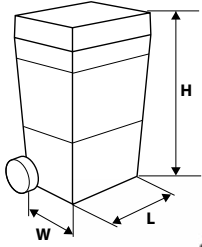

Ref.	L [mm]	W [mm]	H [mm]	☒	EAN
84-115	495	360	710	0/1	5907558421682

Organizer

Organizer / Organizer / Οργαναίεζερ / Οργαναίεζερ / Szortimenter / Organizer / Organizér / Organizér plast. na spoj. materiál / Skatla za orodje / Systemeris / Sikumkaste / Säilituskast / Οργαναίεζερ / Kutija za alat / Kutija za alat / Organizer / Organizador / Organiser / Agenda / Organiseur / Organizer



12 wymiowych pojemników
12 removable containers
12 съёмные контейнеры

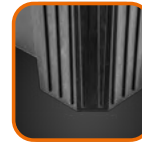

Antywstrząsowe narożniki
Anti-shake corners
Антивибрационные углы



Poliweganowa pokrywa
Polycarbonate cover
Поликарбонатная крышка



Aluminiowe zapięcie
Aluminum clasp
Алюминиевая застёжка



Ref.	info	☒	EAN
84-130	40 x 40 x 12 cm	0/1	5907558431216

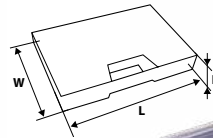

Ref.	L [mm]	W [mm]	H [mm]	☒	EAN
84-118	390	290	65	0/1	5907558439229
84-119	490	390	65	0/1	5907558439236



Plecak monterski

Tool backpack / Monteurgucksack / Рюкзак монтерский / Рюкзак монтерський / Szerszámós hátizsák / Rucsac pentru mecanic / Batoh na náradí / Plecniak na náradie / Nahrbtnik za orodje / Montuotojo įrankių kuprinė / Instrumentu mugursoma / Tööriistade seljakott / Монтьорска раница / Rusak za montere / Monterski ranac / Σάκος εργαλείων / Mochila de montador / Zaino porta utensili / Mochila para ferramentas / Sac à dos porte-outils / Monteur rugzak



POLYESTER
600D



Ref.	☒	EAN
84-304	0/6	5907558425833

Plecak monterski na kołach

Tool backpack with wheels / Monteurgucksack mit Rädern / Рюкзак монтерский на колесиках / Рюкзак монтерський на коліщатах / Szerszámós hátizsák / Rucsac pe roți pentru mecanic / Batoh na náradí na kolečkách / Plecniak na náradie na kolieskach / Nahrbtnik za orodje na kolesih / Montuotojo įrankių kuprinė su ratukais / Instrumentu mugursoma uz riteņiem / Tööriistade seljakott, ratastega / Монтьорска раница на копела / Rusak za montere s kotačima / Monterski ranac sa točkicama / Σάκος εργαλείων με ρόδες / Mochila de montador sobre ruedas / Trolley/zaino in tela / Mochila para ferramentas com rodas / Sac à dos porte-outils à roulettes / Monteur rugzak op wielen



POLYESTER
600D



Ref.	☒	EAN
84-303	0/2	5907558425826

Torba monterska na kołach

Tool bag with wheels / Monteurtasche / Монтерская сумка на колесиках / Торба монтерська на коліщатах / Szerszámátáska / Geantă pe roți pentru mecanic / Taška na náradí na kolečkách / Taška na náradie na kolieskach / Torba za orodje na kolesih / Montuotojo krepšys su ratukais / Instrumentu soma uz riteņiem / Tööriistakott, ratastega / Монтьорска торба на копела / Torba za montere s kotačima / Monterska torba sa točkicama / Τσάντα εργαλείων με ρόδες / Bolsa de montador sobre ruedas / Trolley in tela / Bolsa para ferramentas com rodas / Sac porte-outils à roulettes / Monteurstas op wielen



POLYESTER
600D



Ref.	☒	EAN
84-302	0/2	5907558425819

Stołek z torbą monterską

Chair with tool bag / Sitz mit Monteurtasche / Табурет складной с монтерской сумкой / Столик із монтерською торбою / Szerszámátáska székfunkcióval / Scăunuş cu geantă pentru mecanic / Skládací židle s taškou na náradí / Stolik s taškou na náradie / Mizica s torbo za orodje / Staliukas su montuotojo krepšiu / Taburete ar instrumentu somu / Tööriistakotiga laud / Табуретка с монтьорска торба / Stolica s torbom za montere / Stolica sa monterskom torbom / Πτυσσόμενο οκράνκι με τσάντα εργαλείων / Silla con bolsa de montador / Seggiolino pieghevole con borsa / Banco com bolsa para ferramentas / Sac à outils avec siège pliant / Kruk met monteurstas



POLYESTER
600D



Ref.	☒	EAN
84-306	0/10	5907558425796

Saszetka

Waist bag / Gürteltasche / Поясная сумка / Торба на паску / Övtáska / Borseta / Ledvinka / Ledvinka / Pasna torbica / Deklas / Jostas soma / Vöökott / Паласка / Pasna torbica / Torbica / Τσάντάκι μέσης / Riñonera / Marsupio porta utensili / Bolsa / Sacoche porte-outils à ceinture



Ref.	☒	EAN
84-311	0/70	5907558428377

Torba monterska

Tool bag / Monteurtasche / Сумка монтерская / Торба інструментальна / Szerszámtáska csőalakú fém fogantyúval / Geanta scule / Montérská brašna / Taška montérska kožená / Torba za orodje / Monterio krepšys / Instrumentu soma / Täöriistakott / Купар за инструменти / Torba za alat / Torba za alat / Σάκος για εργαλεία / Bolsa para herramientas / Borsa per meccanica / Sacco p. montaggio / Sac de monteur / Montagetas



Ref.	☒	EAN
84-301	0/2	5907558425802



Ref.	☒	EAN
84-308	0/4	5907558427745



Ref.	☒	EAN
84-300	0/4	5907558417258



Ref.	☒	EAN
84-305	0/6	5907558417265

Pas monterski

Plicer belt / Monteuriemen / Пояс монтерский / Пас для инструмента / Szerszámváltáska övvel / Bandă adezivă / Montérský pás / Opasok na náradie / Pas za orodje / Monterio diržas / Instrumentu josta / Liimimispressi lint / Копан за инструменти / Pojas za alat / Pojas torbica / Ζώνη μονταρίματος / Cinturón para herramientas reforzado / Cintura porta utensili / Cinto p. montagem / Ceinture de monteur / Montagierem



Ref.	☒	EAN
84-315	0/35	5907558428391

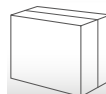

Ref.	☒	EAN
84-330	0/5	5907558415667

Uchwyt na młotek

Hammer holder / Aufnahme für Hammer / Зажим для молотка / Тримач до молотка / Kalapács tartó / Suport pentru ciocan / Držák na kladívko / Upínadlo kladiva / Vpetje za kladivo / Plaktuko rankena / Āmura ietvere / Vasarahoidik / Дръжка на чук / Drška za čekić / Hvat za čekić / Προσαρμογέας σφυριού / Sujeción para martillo / Gancio per martello / Manche de martelet / Houder voor hamer



PVC
1680D

400
g/m²

Ref.	⊠	EAN
84-332	50/100	5907558415681

Pas do kabur

Plicer belt / Monteuriemen / Пояс монтерский / Pas для инструмента / Őv szerszámtáskához / Bandă adezivă / Montérský pás / Opasok na náradie / Pas za orodja / Monterio diržas / Instrumentu josta / Liimimispressi lint / Колан за инструменти / Pojas za alat / Pojas torbica / Ζώνη μονταρίματος / Cinturón para herramientas reforzado / Cintura / Cinto p. montagem / Ceinture de monteur / Montageriem



PVC
1680D

400
g/m²



Ref.	⊠	EAN
84-335	50/100	5907558421941

Materiałowe etui na narzędzia

Textile tool case / Werkzeugkoffer aus Stoff / Текстовые чехлы для инструментов / Текстильні чохли для інструментів / Textil szerszámtartó / Husú textilá pentru scule / Materiálové pouzdro na náradí / Materiálové puzdro na náradie / Etui iz blaga za orodje / Medžiaginis įrankių dėklas / Auduma apvalki instrumentiem / Kangast tööriistavuttlar / Платнен налф за инструменти / Etui za alat / Kutije za alat / Υφασμάτινη θήκη εργαλείων / Estuche textil para las herramientas / Valigetta per utensili in tessuto / Estajo têxtil para as ferramentas / Trousse rangement des outils en tissu / Stoffen gereedschapsetui



22
POUCHES

UNIVERSAL

Ref.	⊠	EAN
09-890	0/40	5907558458923

Uchwyty na nasadki

Socket holders / Steckdosenhalter / Держачелі розеток / Тримачі розеток / Aljzattartók / Suporturi de prize / Držáky zásuvek / Držiaky na zásuvky / Držala za vtičnice / Kištukinių lizdų laikikliai / Kontaktligzdu turētāji / Pistikupesade hoidikud / Дръжачи за гнезда / Držáči utičnica / Дръжачи утичница / Υποδοχές πρίζας / Soportes para enchufes / Portaprese / Porta-soquetes / Supports de douilles



ABS 360° x6 1/4" 3/8" 1/2"



Ref.	⊠	EAN
08-002	0/20	5907558473964

Kieszzeń na narzędzia

Tool pocket / Werkzeugtasche / Сумка для инструментов / Карман для инструмента / Szög és szerszámtartó / Buzunar pentru scule / Kapsa na náradí / Vrecko na náradie / Žep za orodja / Deklas įrankiams / Instrumentu somiņa / Tööriistatasku / Презрадна за инструменти / Futrola za alate / Džep za alat / Τοάντα εργαλείων / Portaherramientas / Marsupio porta utensili / Bolso p. ferramentas / Poche à outils / Gereedschapszak



x4
PVC
1680D
400
g/m²

Ref.	⊠	EAN
84-333	0/50	5907558415698



x8
PVC
1680D
g/m²

Ref.	⊠	EAN
84-334	20/40	5907558415704

Perforacja narzędziowa

Tool wall / Werkzeuglochung / Панель перфорированная для инструментов / Панель інструментальна / Szerszámosfal / Suport perete pentru unelte / Perforace pro uchycení držáků náradí / Panel na náradie / Stenski regal / Sienele įrankiams / Instrumentu plaukts / Tööriistaalus / Перфорация на инструменти / Perforirani organizer za alate / Polica za alat / Τοίχος για εργαλεία / Tablero organizador para herramientas / Perforazione per attrezzi / Perforação de ferramentas / Plaques perforées pour outils / Gereedschapswand

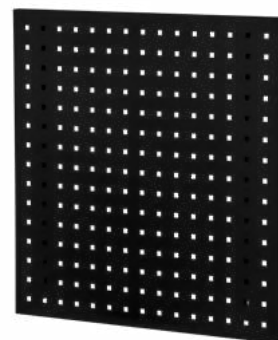

60 cm
60 cm
± 2 cm

steel
thickness
0.8
mm

steel
cold
SPCC

includes
WALL
PLUGS

Ref.	H [mm]	W [mm]	D [mm]	⊠	EAN
84-500	600	600	20	0/1	5907558454253

Hak na pojemnik

Hooks / Hacken / Крючки / Гаки / Horgok / Cârlițe / Háky / Skoby / Kljčke / Kabliai / Āķi / Haagid / Кукы / Kuke / Kuke / Γάντζοι / Ganchos / Ganci / Anzóis / Crochets / Haken



steel
cold
SPCC

steel
thickness
1.0
mm

10x6
cm

Ref.	⊠	EAN
84-502	250/250	5907558454277



steel
cold
SPCC

steel
thickness
1.0
mm

13x6.5
cm

Ref.	⊠	EAN
84-503	250/250	5907558454284

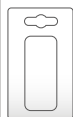

Haki

Hooks / Hacken / Крюки / Гаки / Horgok / Cârlige / Háky / Skoby / Kljuka / Kabliai / Āķi / Haagid / Кюки / Kuke / Kuke / Γάντζοι / Ganchos / Ganci / Anzóis / Crochets / Haken

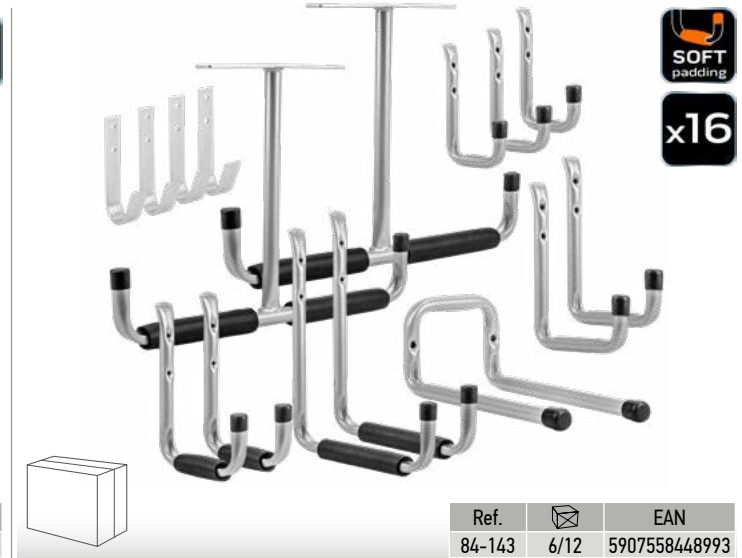

Wózek transportowy

Multipurpose trolley / Transportwagen / Тележка грузовая / Візок транспортувальний / Molnárkocsi / Cărucior de transport / Přepravní vozík / Prepravný vozík / Transportni voziček / Maišelis transportavimui / Ratiņi / Veokāri / Транспортна колица / Transportna kolica / Transportna kolica / Καρότσια μεταφοράς / Carretilla de transporte / Carrello di trasporto / Carrinho de transporte / Chariot de manutention / Transportwagen



Platforma transportowa

Transport platform / Транспортная платформа / Plataforma de transport / Anyagmozgató kocsi / транспортна платформа / Dopravná plošina / Transportní plošina / Transportplattform / Transportna platforma / Transporto platforma / Transporta platforma / Transportdiplavorm / Транспортна платформа / Transportna platforma / Транспортна платформа / Πλατφόρμα μεταφοράς / Plataforma de transporte / Piattaforma di trasporto / Plataforma de transporte / Plateforme de transport / Transportplattform



Ref.	capacity [kg]	☒	EAN
84-141	200	0/6	5907558448979

Najazd samochodowy

Car ramp / Autorampe / Автомобильная рампа / Автомобильна рампа / Autó rármpa / Rampa auto / Nájazd na auto / Nájazd na auto / Autorampa / Automobilij rampa / Auto rampa / Auto kaldtee / Рампа за кола / Rampa za auto / Ауто рампа / Рáмпа аутокινήτου / Rampa de coche / Rampa per auto / Rampa de carro / Rampe de voiture / Auto oprijplaat

910x310x170 mm 3000kg 2pcs PP



Ref.	[t]	☒	EAN
10-478	3	1/1	5907558495874

Wciągarka łańcuchowa

Chain block / Kettenwinde / Лебедка цепная / Таль ланцюгова / Láncos emelő / Trolju cu lant / Řetězový kladkostroj / Retazový zdvihák / Verižna dvigalka / Grandininé gerve / Kēdes vinča / Kettvints / Вержна лебедка / Lančani podizač / Lančana dizalica / Βαρούλκο με αλυσίδα / Cabria de cadena / Paranco a catena / Guincho de corrente / Treuil à chaîne / Kettingtakel



Ref.	[t]	L [m]	☒	EAN
11-760	1	3	0/1	5907558418385
11-761	2	3	0/1	5907558418392
11-762	3	3	0/1	5907558418408
11-763	5	3	0/1	5907558418415

Taśma do bagażu

Luggage strap / Gepäckband / Лента для багажа / Стрічка багажна / Rakományrögzítő / Bandă de bagaje / Popruh na zavazadla / Pás na náklady / Trak za prtljago / Krovinių tvirtinimo juosta / Bagāžas lente / Koormarijmad / Лента за багаж / Traka za prtljagu / Traka za prtljag / Ταίρια αποσκευών / Cinta para maleta / Cinghie con cricchetto / Fita p. Bagagem / Bande à bagage / Bagageband

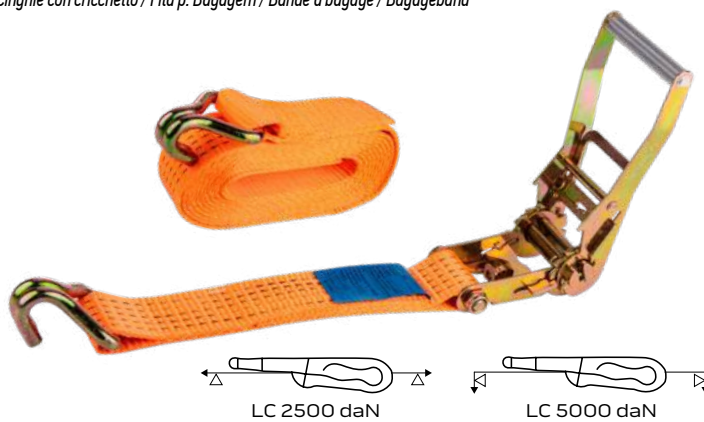

Ref.	KG	L [m]	W [mm]	☒	EAN
84-140	2500 / 5000	5	50	0/10	5907558448962

Gumowy klin pod koło z uchwytem

Car ramp / Autorampe / Автомобильная рампа / Автомобильна рампа / Autó rármpa / Rampa auto / Nájazd na auto / Nájazd na auto / Autorampa / Automobilij rampa / Auto rampa / Auto kaldtee / Рампа за кола / Rampa za auto / Ауто рампа / Рáмпа аутокινήτου / Rampa de coche / Rampa per auto / Rampa de carro / Rampe de voiture / Auto oprijplaat



Ref.	☒	EAN
11-477	1/1	5906692024223

Podnośnik pneumatyczny

Air floor jack / Werkstattheber / Пневматический домкрат / Кран гаражний / Műhelydaru / Cric de atelier / Dilenský zvévad / Dielenský zdvihák / Dvigalka / Keltuvus dirbtuvėms / Profesionālais pacēlājs / Tūkojātungraud / Подвизач / Radionička dizalica / Radionička dizalica / εργαός για γκαράζ / Gato de taller / Cric da officina / Elevador de oficina / Vérin d'atelier / Werkplaats hijstoestel



3T

MAX 420 mm MIN 145 mm

6-12 bar

16,5 kg

Ref.	[t]	☒	EAN
11-737	3.0	0/1	5907558476125

Podnošnik warsztatowy

Shop crane / Werkstattheber / Внутрицеховой кран / Кран гаражний / Műhelydarú, motorkiemelő zsiráf / Cric de atelier / Dilenský zvedák / Dielenský zdvihák / Dvigalka / Keltuväs dirbtuvėms / Profesionālais pacēlājs / Töökajaturgraud / Ποδηλατήρας / Radionička dizalica / Radionička dizalica / Γερανός για γκαράζ / Gato de taller / Gruetta / Elevador de oficina / Vérin d'atelier / Werkplaats hijstoestel

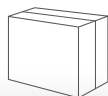

Ref.	[t]	H [mm]	☒	EAN
11-720	2	25-2382	0/1	5907558419665

Podstawki pod samochód

Jack stands / Kfz-Unterlagen / Подставки автомобильные / Підставка під автомобіль / Emelő bak / Support de ridicare / Podpěra panenka / Podpera panenka / Podstavki za hidravlično dvigalko / Automobilinis domkratas / Paliktinis žem auto / Tungraua alused / Стойки за кола / Držáč za auto dizalicu / Drzac za auto dizalicu / Τρύλος σταθερός / Soporte para coche / Cavalletti di sollevamento / Suporte para carro / Supports pour voiture / Autosteunen



Ref.	[t]	H [mm]	☒	EAN
11-750	3	295 - 415	1/1	5907558418361
11-751	2	278 - 423	1/1	5907558418378

Podnošnik przesuwny

Floor jack / Schiebeheber / Домкрат подкатной / Домкрат / Aluminium hydraulikus krokodilemelő / Cric de podea / Přenosný zvedák / Zdvihák hydraulický vozík / Hidravlična dvigalka / Domkratas / Pacēlājs / Tungraud / Кран / Hidraulična auto dizalica / Hidraulična auto dizalica / Τρύλος πρόλληυ / Gato hidráulico / Sollevatore a carrello / Elevador de deslize / Cric mobile / Schuifhijstoestel

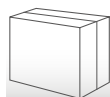

Ref.	[t]	☒	EAN
11-730	1.25	0/1	5907558416930

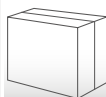

Ref.	[t]	☒	EAN
11-731	2.5	0/1	5907558416947

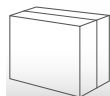

Ref.	[t]	☒	EAN
11-732	3.0	0/1	5907558436716

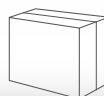

Ref.	[t]	☒	EAN
11-733	2.5	0/1	5907558476132

Podnośnik słupkowy

Bottle jack / Säulenhebergerät / Домкрат гидравлический бутылочный / Домкрат пляшковиый / Palackemelő / Cric coloană / Zvedák pistový / Stĺpikový zdvihák / Dvigalka / Hidraulinis keltuvas / Mastu pacēlājs / Latt-tungraud / Колонен подъемник / Stupna dizalica / Stubasta dizalica / Γρύλος υδραυλικός μπουκάλος / Gato hidráulico de botella / Sollevatore a bottiglia / Elevador com colunas / Cric bouteille / Paalhijstoestel



Ref.	[t]	H [mm]	☒	EAN
10-450	2	181 - 345	1/6	5907558470468
10-451	3	195 - 370	1/6	5907558470475
10-452	5	215 - 413	1/4	5907558470482
10-453	8	230 - 456	1/4	5907558470499
10-454	10	230 - 460	1/4	5907558470505
10-455	15	230 - 460	1/2	5907558470512
10-456	20	240 - 452	1/2	5907558470529

Leżanka warsztatowa

Car creeper / Werkstattliege / Лежанка рабочая / Візок на роликах для / Роботи під автомобілем / Szerelőgy, összecuszkható / Sezlong de atelier / Dilenská lehátko / Montážne ležadlo / Delavniški ležalnik / Sulankstoma lova, dirbtuvėms / Darba guļamkrēsls / Veerevalus / Монтёрско килпимче / Radionička ležaljka / Radionički kauč / Ξαλωστρα συνεργείου / Camilla de taller / Lettino sottomacchina / Carrinho de oficina / Divan d'atelier / Werkplaatsbank



93x44x10.5
cm

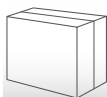

Ref.	m _{max} [kg]	☒	EAN
11-600	150	0/1	5907558418347



40x14x102
/
54.5x40.5x48
cm

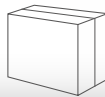

Ref.	m _{max} [kg]	☒	EAN
11-601-1	150	1/1	5907558445282

Składana mata do pracy pod samochodem

Foldable mat for working under the car / Faltbare Matte für Arbeiten unter dem Auto / Складной коврик для работы под автомобилем / Складний килпимок для роботи під автомобілем / Összecuszkható szőnyeg az autó alatti munkához / Covoraş pliabil pentru lucrul sub maşină / Składací podložka pro práci pod autem / Kladacia podložka na prácu pod autom / Skladacia podložka na prácu pod autom / Sulankstomas kilimėlis darbuui po automobiliu / Salokāms pakļājīgs darbam zem automašīnas / Kokkupandav matt auto all töötamiseks / Създаема постелка за работа под колата / Sklopiva prostirka za rad ispod automobila / Sklopiva prostirka za rad ispod automobila / Πτυσσόμενο χαλί για εργασία κάτω από το αυτοκίνητο / Alfombra plegable para trabajar debajo del coche / Tappetino pieghevole per lavorare sotto l'auto / Tapete dobrável para trabalhar embaixo do carro / Tapis pliable pour travailler sous la voiture / Opvouwbare mat voor werkzaamheden onder de auto

120x
40x2
cm

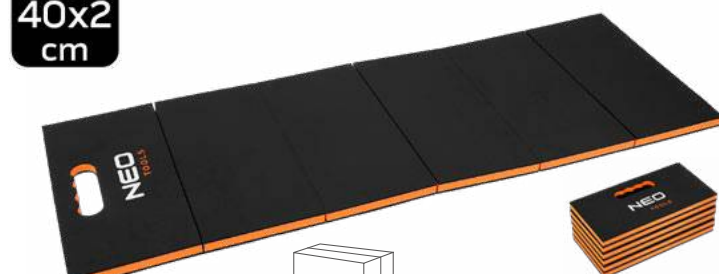

Ref.	☒	EAN
10-599	0/4	5907558473957



Stolek warsztatowy na kółkach

Workbench on wheels / Верстатний стілець на коліщатах / Scaun de atelier pe roți / Műhelyszék kerekeken / Sgabello da officina su ruote / Tabouret d'atelier à roulettes / Werkstattthocker auf Rollen / Верстачный ступ на колесах / Montážní stolička na kolečkách / Dielenská stolička na kolieskach / Radionički stolac na kotačićima / Dirbtuvių taburetė ant ratukų / Darbnīcas krēsls uz riteņiem / Delavniški stol na kolesih / Работен стол на колела / Radionička stolica na točkice / Εργαστηριακό σκαμνό με ροδάκια / Werkbank op wielen / Banco de oficina com rodas / Taburete de taller con ruedas / Tööpink ratastel



Ref.	☒	EAN
11-605		5906692015757



Ref.	☒	EAN
11-604		5907558477269

Stojak na silnik

Engin stand / Motorhalter / Стенд для ремонта двигателя / Стенд для ремонту двигуна / Motorszerelő állvány / Stativ pentru motor / Stojan na motor / Stojan na motor / Stojalo za motor / Variklio stovas / Dzinēja remonta statīvs / Mootoristend / Стойка за двигател / Stalak za motor / Stalak za motor / Βάση επισκευής κινητήρων / Soporte para motor / Cavalletto supporto motore / Suporte de motor / Support moteur / Motor onderstel



Ref.	☒	EAN
11-710	0/1	5907558436662

Belka do podnoszenia silnika

Engine beam hoist / Balken zum Anheben des Motors / Балка для подъема двигателя / Балка для підйому двигуна / Motoremelő gerenda / Bară pentru ridicarea motorului / Nosník pro zvedání motoru / Nosník na zavesenie motora / Dvigalka za avtomobilski motor / Variklio keltuvas / Sija motora pacelšanai / Mootori tõstmise tala / Греда за повдигане на двигателя / Greda za podizanje motora / Greda za podizanje motora / Τραβέρσα ανύψωσης κινητήρων / Viga elevadora para el motor / Trave di sollevamento del motore / Viga elevadora do motor / Barre support moteur / Balk voor het heffen van de motor



Ref.	☒	EAN
11-749	0/1	5907558459760

Podnošnik do skrzyń biegów

Transmission jack / Getriebeheber / Трансмисионна стойка / Стійка трансмісійна / Sebességváltó emelő / Cric pentru cutia de viteze / Zvedák převodovek / Zdvih prevodovky / Dvigalo za menjalnik / Pavarų dėžės keltuvas / Átrumkärbas domkrats / Käigukasti tungraud / Трансмисионен подемник / Podizač mjenjača / Dizalica za menjač brzina / Σασμανόγυλος / Elevador de caja de engranajes / Martinetto per scatole del cambio / Elevador da caixa de velocidades / Jack de transmission



Ref.	☒	EAN
11-712	0/1	5907558436679



Ref.	☒	EAN
11-711	1/1	5907558445534

Prasa hydrauliczna

Hydraulic press / Hydraulische Presse / Гидравлический пресс / Прес гидравлічний / Hidraulikus prés / Preša hydraulická / Hydraulický lis / Hydraulický lis / Hidravlična stiskalnica / Hidraulinis presas / Hidrauliskā prese / Hüdraliline press / Χυδραυλικά πρέσα / Hidravlična preša / Hidravlična presa / Υδραυλική πρέσα / Prensa hidráulica / Pressa idraulica / Prensa hidráulica / Presse hydraulique



20T

0-905 mm

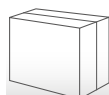

Ref.	☒	EAN
11-714	0/1	5907558436686

Stół warsztatowy

Work bench / Werkstattbank / Стол-верстак / Верстак / Állítható munkapad / Tejghea tímplárie / Dilenský stůl / Stolik pracovný / Delavníška miza / Darbastalis / Darba galds / Tööpink / Работна маса / Stol radionički / Radni sto / Πάγκος εργασίας / Banco de trabajo / Banco da lavoro / Mesa de oficina / Etabli d'atelier / Werkplaatstafel



1500x
780x830
mm

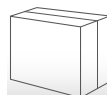

Ref.	[mm]	☒	EAN
11-716	1500 x 780 x 830 – 980 mm	0/1	5907558436693

Mata serwisowa na błotniki, magnetyczna

Car body servis cover, magnetic / Servicematten für Kotflügel, magnetisch / Накладка магнитная на крыло / Накладки магнітні до брызговики / Mágneses sárvédő takaró / Rogojini servicii pentru aripi, magnetice / Ochranné přehozy na blatníky, magnetické / Servisné rohože pre blatníky, magnetické / Servisne obloge za blatnike, magnetne / Apsauginė magnetinė danga ant sparno / Mašīnas spārna magnētiskais paklājs instrumentiem / Porilaudade hooldusmatid, magnetilised / Магнітно покрывало за калници / Servisne mate za blatovrane, magnetske / Servisne podloge za branike, magnetne / Μαγνητική ποδιά φτερού / Alfombras de servicio para guardabarros, magnéticas / Stuoie per manutenzione sui parafranghi, magnetiche / Coberturas magnéticas para para-lamas / Bâches de garde-boue magnétiques / Service matten voor spatlappen



1200x1000
mm



Ref.	☒	EAN
11-718	0/20	5907558436709



1000x630
mm



Ref.	☒	EAN
11-719	0/25	5907558459753

Odkurzacz akumulatorowy

Cordless vacuum cleaner / Пылосос акумулаторний / Aspirator de praf cu acumulator / Akkumulátoros porszívó / Aspirapolvere a batteria / Aspirateur à batterie / Akku-Staubsauger / Пылесос акумулаторный / Akumulátorový vysavač / Vysavač akumulátorový / Akumulatorski usisavač / Akumulátorinis siurblys / Akumulatora putekļsūcējs / Akumulatorski sesalnik / Акумуляторна Прохосмувачка / Bežični usisivač / Ασύρματα Ηλεκτρική σκούπα / Draadloze stofzuiger / Aspirador sem fio / Aspiradora a batería / Juhtmeta tolmuiumeja

GRAPHITE
ENERGY+
system
NEO GRAPHITE

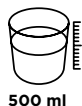

500 ml



18V Li-Ion



Ref.	☒	EAN
58G097	1/4	5902062065391

Odkurzacz warsztatowy

Workshop vacuum cleaner / Werkstattstaubsauger / Пылесос промышленный / Пылесос професійний / Műhelyporszívó / Aspirator atelier cu sistem vacuum / Dilenský vysavač / Dielenský vysávač / Industrijski sesalnik / Pramoninis siurblys / Rūpniecības putekļsūcējs / Tööstuslik tolmuiumeja / Промышленна прохосмувачка / Radionički usisivač / Industrijski usisivač / Ηλεκτρική σκούπα επαγγελματική / Aspirador / Aspirapolvere da officina / Aspirador de oficina / Aspirateur d'atelier / Werkplaatstofzuiger

GRAPHITE
ENERGY+
system
NEO GRAPHITE



18V Li-Ion



150W



10l



Ref.	☒	EAN
58GE105	1/4	5902062073013

Odkurzacz warsztatowy

Workshop vacuum cleaner / Werkstattstaubsauger / Пылесос промышленный / Пилосос професійний / Műhelyporszívó / Aspirator atelier cu sistem vacuum / Dílenský vysavač / Dielenský vysávač / Industrijski sesalnik / Pramoninis siurblys / Rūpniecības putekļsūcējs / Tööstuslik tolmuimeja / Промышленна прахосмукачка / Radionički usisavač / Industrijski usisivač / Ηλεκτρική σκούπα επαγγελματική / Aspirador / Aspirapolvere da officina / Aspirador de oficina / Aspireur d'atelier / Werkplaatsstofzuiger

GRAPHITE

ENERGY+
system
NEO GRAPHITE



SILNIK
BEZSZCZOTKOWY
BRUSHLESS
MOTOR

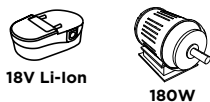

18V Li-Ion

180W

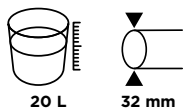

20 L

32 mm



Ref.	[kg]	☒	EAN
58GE124	4.9	0/1	5902062082572

GRAPHITE

ENERGY+
system
NEO GRAPHITE

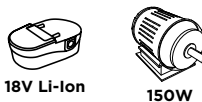

18V Li-Ion

150W

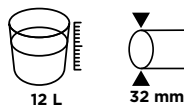

12 L

32 mm



Ref.	[kg]	☒	EAN
58GE133	3.8	0/1	5902062096333

Odkurzacz przemysłowy

Industrial vacuum cleaner / Industriestaubsauger / Пылесос промышленный / Пилосос промисловий / Ipari porszívó / Aspirator industrial / Průmyslový vysavač / Priemyselný vysávač / Industrijski sesalnik / Pramoninis dulkių siurblys / Rūpnieciskais putekļsūcējs / Tööstuslik imur / Промышленна прахосмукачка / Industrijski usisavač / Industrijski usisivač / Βιομηχανική ηλεκτρική σκούπα / Aspirador industrial / Aspiratore industriale / Aspirador industrial / Aspireur industriel / Industriële stofzuiger

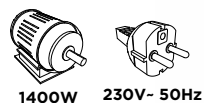

1400W

230V- 50Hz

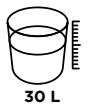

30 L

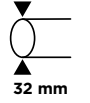

32 mm



MAX 2000W



Ref.	[kg]	☒	EAN
04-738	8.3	0/1	5907558483079

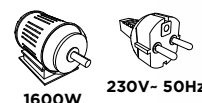

1600W

230V- 50Hz

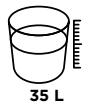

35 L

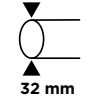

32 mm



MAX 1800W



Ref.	[kg]	☒	EAN
04-739	10.4	0/1	5907558483086

Myjka ciśnieniowa

High pressure washer / Hochdruckreiniger / Мойка высокого давления / Мойка високого тиску / Magashnyomású mosó / Mašina de spjalat cu presiune / Tlaková myčka / Tlaková umývačka / Tlačni pralnik / Slėginis plovimo įrenginys / Spiediena mazgātājs / Мыльная машина под налягане / Visokotlačni peráč / Hidrolimpiadora / lãdopolitrice / Máquina de lavar a pressão / Nettoyeur haute pression / Hogedrukreiniger

**MAX 135
BAR**

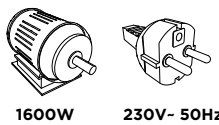

1600W

230V- 50Hz



max 60°C



Ref.	[kg]	☒	EAN
04-630	5.5	0/1	5907558477955

**MAX 165
BAR**

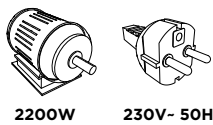

2200W

230V- 50Hz



max 60°C



Ref.	[kg]	☒	EAN
04-631	5.5	0/1	5907558477962

NARZĘDZIA RĘCZNE MECHANICZNE

mechanical hand tools механічні ручні інструменти



Szafka narzędziowa

Tool cabinet / Werkzeugschrank / Шкафчик для инструментов / Шафа інструментальна / Műhelykocsi / Dulap pentru scule / Skříňka na nářadí / Skrinka na náradie / Omarica za orodje / Įrankių spintelė / Instrumentu skapis / Tööriistakapp / Шкафче за инструменти / Ormar za alate / Ormaric za alatke / Ντουλαράκι για εργαλεία / Armario de almacenaje para herramientas / Carrello porta utensili / Estante p. Ferramentas / Rmoire à outils / Gereedschapskast

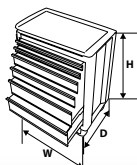
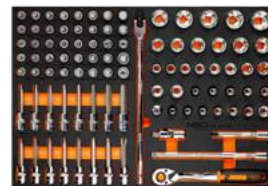

359 elements

Ref.	D [mm]	W [mm]	H [mm]	capacity [kg]	☒	EAN
84-225-6	465	1105	978	600	0/1	5906692018307

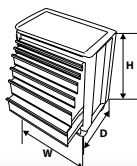
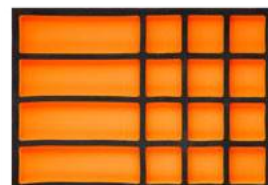

330 elements

Ref.	D [mm]	W [mm]	H [mm]	capacity [kg]	☒	EAN
84-220-6	465	775	978	300	0/1	5906692018277

Szafka narzędziowa

Tool cabinet / Werkzeugschrank / Шкафчик для инструментов / Шафа інструментальна / Műhelykocsi / Dulap pentru scule / Skříňka na nářadí / Skrinka na náradie / Omarica za orodje / Įrankių spintelė / Instrumentu skapis / Тооrиистакарр / Шкафче за инструменти / Ormar za alate / Ormaric za alatke / Ντουλαπάκι για εργαλεία / Armario de almacenaje para herramientas / Carrello porta utensili / Estante p. Ferramentas / Rmoire à outils / Gereedschapskast



129 elements



84-236

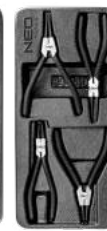

84-240



84-230



84-242



84-237



84-238



84-235



84-234



84-232

Ref.	D [mm]	W [mm]	H [mm]	capacity [kg]	☒	EAN
84-222-9	460	680	1030	280	0/1	5907558426441



176 elements



84-230



84-231



84-232



84-233



84-234



84-236



84-237



84-239



84-238

Ref.	D [mm]	W [mm]	H [mm]	capacity [kg]	☒	EAN
84-222-12	460	680	1030	280	0/1	5907558426427



149 elements



84-230



84-231



84-232



84-233



84-234



84-236



84-237



84-239



84-238

Ref.	D [mm]	W [mm]	H [mm]	capacity [kg]	☒	EAN
84-221-9	460	680	1030	280	0/1	5907558426403

Szafka narzędziowa

Tool cabinet / Werkzeugschrank / Шкафчик для инструментов / Шафа инструментальна / Műhelykocsi / Dulap pentru scule / Skříňka na nářadí / Skrinka na náradie / Omaraica za orodje / Įrankių spintelė / Instrumentu skapis / Τοορίστακάρπ / Шкафче за инструменти / Ormar za alate / Ormaric za alatke / Ντουλαπάκι για εργαλεία / Armario de almacenaje para herramientas / Carrello porta utensili / Estante p. Ferramentas / Rmoire à outils / Gereedschapskast

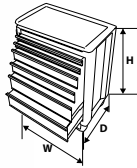

84-230



84-234



84-236



84-237



84-238



84-247



117 elements

Ref.	D [mm]	W [mm]	H [mm]	capacity [kg]	☒	EAN
84-214-6	460	680	825	280	0/1	5907558426380

Szczypce

Pliers set / Zange / Клепци / Плассокубы, набір / Fogókészlet / Set clește plat / Kleště / Klešte, súprava / Klešče / Replės / Крайблү комплекς / Nāpītsate komplekt / Щипцы / Klijesta / Klesta set / Συλλογή πεσσών / Alicates / Pinza / Pinças / Pince / Tangen



x5



55-60 HRC

DIN 5745

DIN 5746

DIN 5749

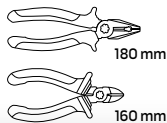

180 mm

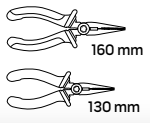

160 mm

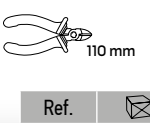

110 mm



Ref.	☒	EAN
84-230	0/10	5907558424270

Szczypce do pierścieni osadczyc

Circlip pliers / Zange für Stellringe / Щипцы для стопорных колец / Щипцы для стопорних кілець / Zégergyűtő fogókészlet / set clește cu spirală / Kleště pro stavěcí kroužky / Segerky vonkajšie rovné / Klešče seger / Replės žiedams / Sprostgredzenu stangas / Vedrunāpītsad / Клепци Зєєр / Kružna Klijesta / Kruzna klesta / Ασφαλειοταιμίδες / Alicates para anillos de asiento / Set di pinze per anelli elastici / Pinças p. Anéis / Pince pour bagues de retenue / Tang voor dopringen

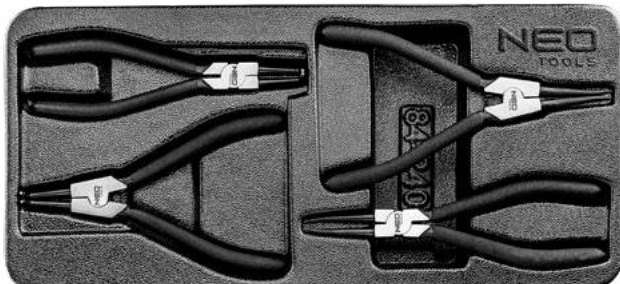

CrV steel

x4

180 mm, zewnętrzne, proste / external, stright tip / щипцы для внешних/прямые
 170 mm, zewnętrzne, wygięte / external, bent tip / щипцы для внешних/загнутые
 180 mm, wewnętrzne, proste / internal, stright tip / щипцы для внутренних/прямые
 170 mm, wewnętrzne, wygięte / internal, bent tip / щипцы для внутренних/загнутые

Ref.	☒	EAN
84-240	0/10	5907558424379

Zestaw narzędzi

Tools set / Werkzeugsatz / Набор инструментов / Набор інструментів / Szerszámkészlet / Set scule de grădină / Sada nářadí / Súprava náradia / Garnitura orodja / Įrankių komplektas / Instrumentu komplekts / Τοορίστακονπλεκς / Теодоре конплекς / Set uređaja / Set alata / Συλλογή εργαλείων / Juego de herramientas / Set utensili / Kit de ferramentas / Jeu d'outils / Gereedschapset



x5

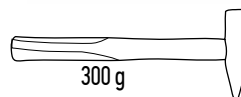

300 g

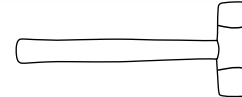

30 mm



10; 13; 16 mm

Ref.	☒	EAN
84-242	0/10	5907558424393

Pilniki

Files / Feilen / Напильники / Напильки / Reszelő készlet / Pile / Pilniki / Pilniki / Pile / Dildés / Viles / Viilid / Пилу / Турпје / Турпје / Лїмес / Sopletes / Set di lime / Limas / Limes / Vijlen



x5



2



200 mm



Ref.	☒	EAN
84-244	0/10	5907558424416

Wkrętaki

Screwdriver set / Schraubendreher / Отвертки / Відкрутки, набір / Fogókészlet / Set şurubelnițe / Šroubováky / Súprava skrutkovačov / Garnitura izvijačev / Atskutuvai / Skrūvgriežu komplekts / Krivikeerajate komplekt / Отвертки компл. / Odvijaci / Odvijac set / Συλλογή από καταβίδια / Destornilladores / Set giravite piatti / Chaves de fenda / Tournevis / Schroevendraaiers



3.0 x 75; 5.5 x 100; 5.5 x 200; 6.5 x 38;
6.5 x 125; 6.5 x 150; 8.0 x 150 mm



PH0 x 75 mm; PH1 x 75 mm; PH1 x 100 mm; PH2 x 38 mm;
PH2 x 100 mm; PH2 x 150 mm; PH3 x 150 mm



PH00; PH0; PH1 T10; T15; T20; T25
PZ0; PZ1; PZ2 SL 2mm; SL 3mm

Ref.	⊠	EAN
84-247	0/10	5907558424447

Klucze nasadowe

Drive socket set / Steckschlüssel / Набор сменных головок / Ключи торцевые / Dugókulcskészlet / Trusa tubulara / Nástrčné kľuče / Nástrčné kľuče / Nasadni ključci / Veržlerakció antalgiai / Nomainámo galvu komplekts / Padrīnātmed / Сменная накруайница за ключове / Nasadni ključevci / Ključevci natikači / Σετ με καρδιάκια / Llaves de vaso / Set bussole / Chaves articuladas / Clefs à douilles / Dopsleutels

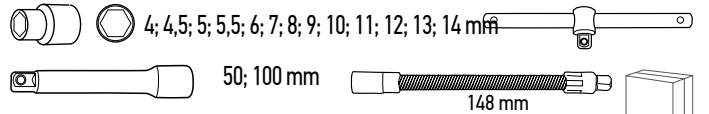

Ref.	⊠	EAN
84-237	0/10	5907558424348

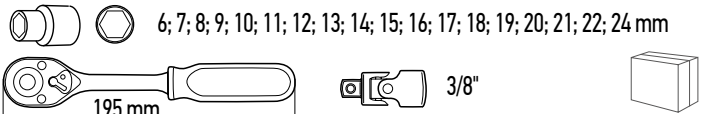

Ref.	⊠	EAN
84-239	0/10	5907558424362

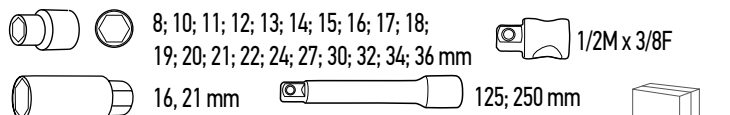

Ref.	⊠	EAN
84-238	0/6	5907558424355

Nasadki udarowe

Impact sockets / Schlagaufsätze / Насадки ударные / Патрони перфораторні / Gépi dugókulcs készlet / Břítare percutante / Příkladové nástavce / Příkladové nástavce / Udarni nasadni ključ / Kalimo antgaliai / Triecienuzgaļi / Löökotsakud / Ударни наставкаи / Udarni nasadni nastavci / Udarne kapice / Υποδοχές κρουστικής ανταλλακτικής / Llaves de vaso para atornilladores de impacto / Set bussole a percussione / Bocais de impacto / Douilles de choc / Slagdoppen

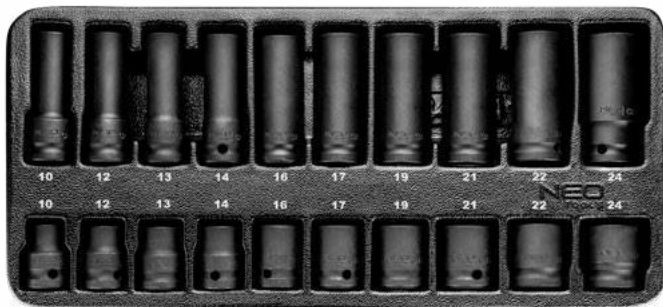

10; 12; 13; 14; 16; 17; 19; 21; 22; 24 mm

10; 12; 13; 14; 16; 17; 19; 21; 22; 24 mm

Ref.	✉	EAN
84-241	0/10	5907558424386

Nasadki sześciokątne długie

Hexagonal sockets / Sechskantaufsätze / Головки сменные шестигранные / Насадки шестигранные / Dugókulcs hosszú készlet / Capete tubulare hexagonale / Šestihránné nástavce / Šestihránné nástavce / Šestkotni nasadni ključ / Šešiakampiai antgaliai / Seštūra nomaināms galvas / Kuuskantpadrunid / Шестьугольные наставкаи / Šesterokutne kapice / Šestougaone nasadke / Καρυδάκια εξάγωνα / Vasos hexagonales / Set bussole / Bocais hexagonais / Douilles à 6 pans / Zeskant doppen

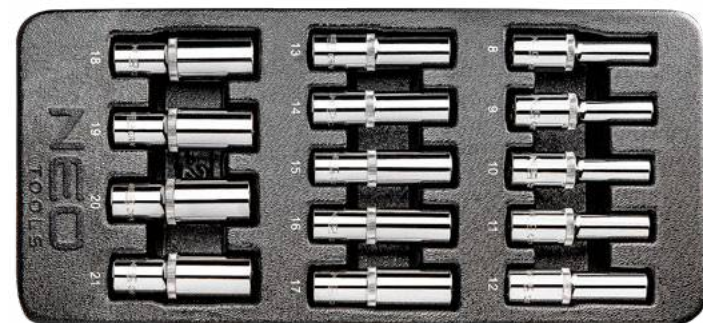

8, 9, 10, 11, 12, 13, 14, 15, 16, 17, 18, 19, 20, 21 mm

Ref.	✉	EAN
84-243	0/10	5907558424409

Końcówki wkrętakowe

Driver bits / Einsätze für Schraubendreher / Насадки / Наконечники викруткови / Bitkészlet / Set biti / Šroubovákové nástavce / Skrutkovacie nástavce / Nastavki za izvijače / Atsuktivo antgaliai / Skrivgriega uzgaļi / Krunkveerajaotsakud / Накараїнци за отвёртка / Nastavci za odvijač / Nastavci za odvijač / Καταβρόδύµετες / Puntas destornilladoras / Set inserti / Ponteiros chave de fenda / Embouts de tournevis / Schroevendraaiereindstukken

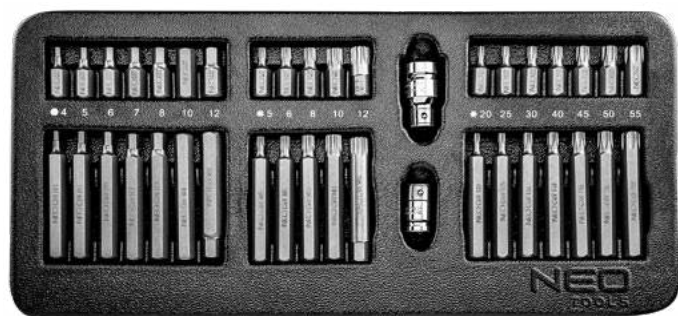

● H4; H5; H6; H7; H8; H10; H12 ● H4; H5; H6; H7; H8; H10; H12
 ● M5; M6; M8; M10; M12 ● M5; M6; M8; M10; M12
 ★ T20; T25; T30; T40; T45; T50; T55 ★ T20; T25; T30; T40; T45; T50; T55

75 mm 30 mm

Ref.	✉	EAN
84-236	0/10	5907558424331

Klucze płasko-oczkowe

Ratchet wrench set / Maul-Ringschlüssel / Ключи комбинированные / Ключи рижково-накидні, набір / Csillag-villáskulcs készlet / Set chei cu clichet / Očkoploché klíče / Súprava OP račiových klúčov / Ključ viličasto-obročni / Raktas plokščias - kilpinis / Kombinēto atslēgu komplekts / Põrkmutrivõtmete komplekt / Ключ зезвздогаечен / Set ključeva / Ključ kombinovani / Συλλογή πολυγώνων καστανιάς / Llaves combinadas (de estrella y a carraca abierta) / Set chiavi combinate / Chaves planas-de luneta / Clefs à fourche polygonales / Moersleutels

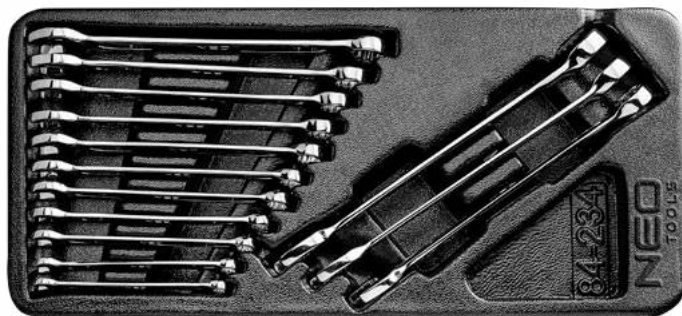

6x100; 7x110; 8x120; 9x130; 10x140; 11x150; 12x160; 13x170; 14x180; 15x190; 16x200; 17x210; 18x220; 19x230 mm

Ref.	✉	EAN
84-234	0/10	5907558424317

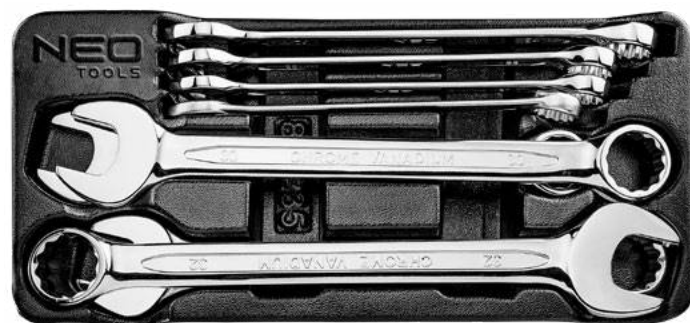

20x240; 21x250; 22x260; 24x280; 27x310; 29x340; 30x340; 32x360 mm

Ref.	✉	EAN
84-235	0/10	5907558424324

Klucze oczkowe odgięte

Offset ring spanner set / Ringschlüssel gebogen / Ключи накидные коленачатые / Ключи накидні колінчасті, набір / Csillagkulcs készlet / Set chei inelare de deviație / Očkové klíče vyhnuté / Súprava očkových klúčov / Garnitura obročnih ključev, upognjenih / Kilpinis, lenktų raktų komplektas / Kombinēto izliekto atslēgu komplekts / "Ofset" mutrivõtmete komplekt / Ключ лула / Ključ okasti / Ključ okasti set / Συλλογή κυρτών πολυγώνων κλειδίων με κεκλιμένη κεφαλή / Llaves de estrella, acodadas / Set chiavi inclinate ad anello / Chaves de luneta curvadas / Clefs polygonales contre-coudées / Gebogen ringsleutels

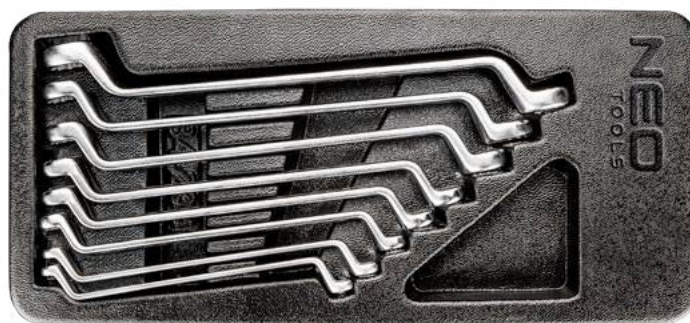

6x7; 8x9; 10x11; 12x13; 14x15; 16x17; 18x19; 20x22 mm

Ref.	✉	EAN
84-233	0/10	5907558424300

Klucze sześciokątne

Hex key wrench set / Sechskantschlüssel / Ключи шестигранные / Ключи шестигранні / Imbuszkulcs készlet / Set chei hexagonale / Ključ šestihranné / Súprava predl. Imbus ključov s guľkou / Garnitura ključev inbus / Šešakampiai raktai / Seškanšu atslēgu komplekts / Kuuskant-mutrivõtmete komplekt / Шестозъелни ключове / Ključ imbus set / Ključ imbus / Εξαγωνικά κλειδιά / Llaves allen / Chiavi esagone / Chaves hexagonais / Clefs à 6 pans / Zeskantsleutels



25 years
GUARANTEE

S2
steel

x6



DOUBLE
COMPONENT
HANDLE

◆ H4; H5; H6; H7; H8; H10; H12

Ref.	☒	EAN
84-254	1/12	5907558483956

Narzynki i gwintowniki

Tap and die set / Schneideisen und Gewindebohrer / Плашки и метчики / Позначники ѓ плашки, набір / Menetkészítő készlet / Set scule tăiere filet interior și exterior / Závítnice a závítníky / Súprava závítníkov / Garnitura vreznikov in nareznikov navoja / Sriegpjovės ir sriegikliai / Vitngriežu komplekts / Kraani ja valuvormi komplekt / Метчици и плашки / Nareznice i ureznice set / Set ureznika i nareznika / Ελικοκόφτες και κολαούζα / Cojinetes y machos de roscar, juego / Set di filiere a maschi / Cassonetes e roscas / Filières et tarauds / Snijplaat en schroefdraad snijtoestel

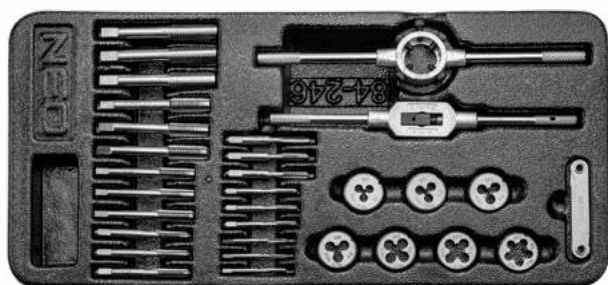

25 years
GUARANTEE



HSS
steel

x31

DIN
352



⊗ M3; M4; M5; M6; M8; M10; M12 - 25 x 9 mm

Ref.	☒	EAN
84-246	0/10	5907558424430

Wkład profilowany

Profiled insert / Profileinsatz / Профилированный вставной элемент / Organáizer / Tároló rekeszes tábla / Cartuş profilat / Profilovaná vložka / Profilovaná vložka / Profiliran vložek / Profiliuotas įdėklas / Profilēts ieliekamais elements / Profilitud tihend / Профилен элемент / Profilirani umetak / Profilisani umetak / Διατάχτη ένθετο εζάρτημα / Bandeja clasificadora perfilada / Vassoio / Cartucco perfilado / Cylindre profilé / Geprofileerde inzetdeel



25 years
GUARANTEE

FULL
DRAWER

550x386 mm

Ref.	☒	EAN
84-249	0/5	5907558424461

Klucze Torx

Torx key set / Torx-Schlüsselset / Ключи torx / Набір кривотових шестигранных торцових ключів «torx» / Torx kulcskészlet / Set chei torx / Ključ Torx / Torxoné ključe / Ključiči torx / Torciniai raktai / Atslēgas torx / Torx-võtmed / Ключове torx / Set torx ključeva / Torx ključevi / Set κλειδιών torx / Llaves torx / Chiavi torx / Chaves torx / Clefs Torx / Torxleutels



25 years
GUARANTEE

S2
steel

x6



DOUBLE
COMPONENT
HANDLE

★ T10; T15; T20; T25; T30; T45

Ref.	☒	EAN
84-264	1/12	5907558483963



Klucze nasadowe

Socket wrenches / Steckschlüssel / Набор сменных головок / Ключи торцевые / Dugókulcskészlet / Trusa tubulare / Nástrčné kľúče / Nástrčné kľúče / Nasadni ključji / Veržlerakció antgaliai / Nomaināmo galvu komplekts / Padrunvõtmed / Сменными наконечниками за ключовые / Nasadni ključevci / Ključevci natičasti / Σετ με καρδιάκια / Llaves de vaso / Set di bussole SuperLock / Chaves tubulares / Clefs à douilles / Dopsuteults

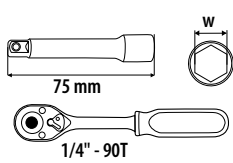

Ref.	W[mm]	⊠	EAN
10-000	4, 4.5, 5, 5.5, 6, 7, 8, 9, 10, 11, 12, 13	5/20	5907558466133

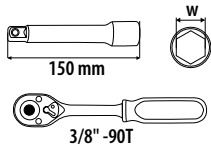

Ref.	W[mm]	⊠	EAN
10-020	8, 10, 12, 13, 14, 16, 17, 19, 21, 22	5/10	5907558466157

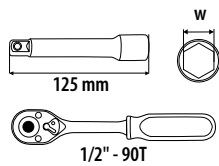

Ref.	W[mm]	⊠	EAN
10-030	8, 10, 12, 13, 14, 16, 17, 19, 21, 22	4/12	5907558466126

Zestaw adapterów

Set of adapters / Набор адаптеров / Set adaptor / Adapterkészlet / Set di adattatori / Jeu d'adaptateurs / Adapter-Satz / Комплект адаптеров / Sada adaptérů / Súprava adaptérov / Set adaptera / Adapterij rinkinys / Adapteru komplekts / Komplet adapterjev / Комплект адаптерів / Адаптер сеп / Σετ προσαρμογέα / Adapterset / Conjunto de adaptadores / Juego de adaptadores / Adapterikomplekt



Ref.	⊠	EAN
10-240	0/0	5906692019366

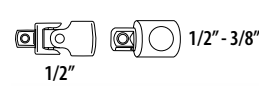
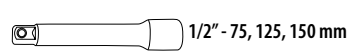
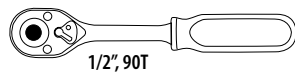
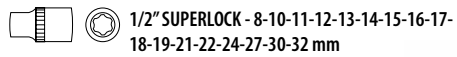

23
elements

Ref.	⊠	EAN
08-694	1/5	5907558440034

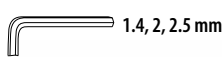
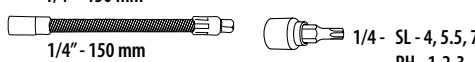
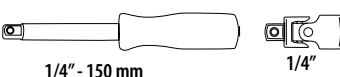
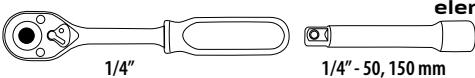
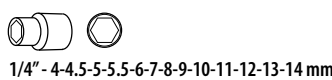

46
elements



Ref.	⊠	EAN
10-004	1/10	5907558465945

Klucze nasadowe

Socket wrenches / Steckschlüssel / Набор сменных головок / Ключи торцевой / Dugókulcskészlet / Trusa tubulare / Nástrčné kľúče / Nástrčné klúče / Nasadni ključiči / Veržlerakció antgaliái / Nomaināmo galvu komplekts / Padrunvõtmed / Сменяемые наконечники за ключом / Nasadni ključeviči / Ključeviči natičakči / Σετ με καρδιάκια / Llaves de vaso / Set di bussole SuperLock / Chaves tubulares / Clefs à douilles / Dopsleutels

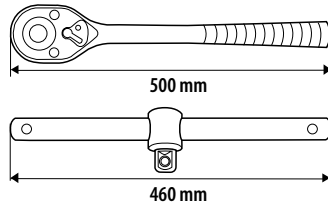
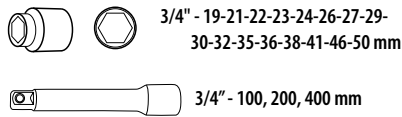

25
years
GUARANTEE



CrV
steel



x21

3/8"

21
elements



Ref.	☒	EAN
08-061	0/1	5907558404173

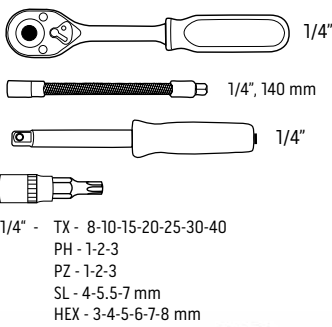
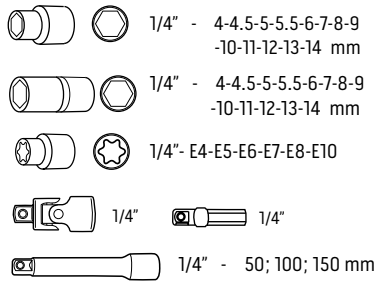

25
years
GUARANTEE

CrV
steel

x63

1/4"

63
elements

PRECISE
4°
90T

NEW
PATENTED
DESIGN



Ref.	☒	EAN
10-008	5/10	5907558466003

Klucze nasadowe

Socket wrenches / Steckschlüssel / Набор сменных головок / Ключи торцевой / Dugókulcskészlet / Trusa tubulare / Nástrčné kľúče / Nástrčné kľúče / Nasadni ključji / Veržlerakció antgaliai / Nomaināmo galvu komplekts / Padrunvõtmed / Сменяемые наконечники за ключом / Nasadni ključevi / Ključevi natičaki / Σετ με καρδιάκια / Llaves de vaso / Set di bussole SuperLock / Chaves tubulares / Clefs à douilles / Dopsleutels



1/2" - 10-11-12-13-14-15-16-17-18
-19-20-21-22-24-27-30-32 mm



1/2" - 10-11-12-13-14-15-17-19 mm



1/2" - 16, 21 mm



1/2"



1/2" - 125, 250 mm



1/2"

1/2"



1/2" - 5/16"

5/16" - FD8-FD10-FD12

PH1-PH2-PH3-PH4

PZ1-PZ2-PZ3-PZ4

T20-T25-T30-T40-T45-T50-T55

H4-H5-H6-H8-H10-H12-H14



25 years
GUARANTEE



CrV
steel

x58

1/2"

PRECISE
4°
90T

NEW
PATENTED
DESIGN



58
elements



Ref.	⊠	EAN
10-042	1/4	5907558466072



1/2" - 10-11-12-13-14-15-16-17-18-19
20-21-22-23-24-27 mm

1/4" - 4-5-5.5-6-7-8-10-11-12-13 mm



1/2" - 90T

1/4" - 90T

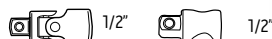

1/2"

1/2"

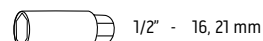

1/2" - 16, 21 mm



1/2" - 125, 250 mm

1/4" - 100 mm

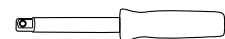

1/4" - 150 mm



1/4"



1,5-2,5 mm



1/4" - TX8, TX10, TX15, TX20, TX25, TX27,
TX30, TX40, PH0, PH1, PH2, PH3,
PZ1, PZ2, PZ3, SL4, SL5.5, SL7, HEX 3,
4, 5, 6, 8, 10, 1/8", 9/64", 5/32",
3/16", 7/32", 1/4", 5/16", SPLINE 6, 8



25 years
GUARANTEE



CrV
steel

x73

1/4"

1/2"



PRECISE
4°
90T

NEW
PATENTED
DESIGN



73
elements



Ref.	⊠	EAN
10-054	1/4	5907558465938

Klucze nasadowe

Socket wrenches / Steckschlüssel / Набор сменных головок / Ключи торцевой / Dugókulcskészlet / Trusa tubulare / Nástrčné kľúče / Nástrčné kľúče / Nasadni ključji / Veržlerakció antgaliai / Nomināmo galvu komplekts / Padrunvõtmed / Сменяемыми наконечниками за ключовые / Nasadni ključevji / Ključevji natičakci / Set me karubákia / Llaves de vaso / Set di bussole SuperLock / Chaves tubulares / Clefs à douilles / Dopsleutels

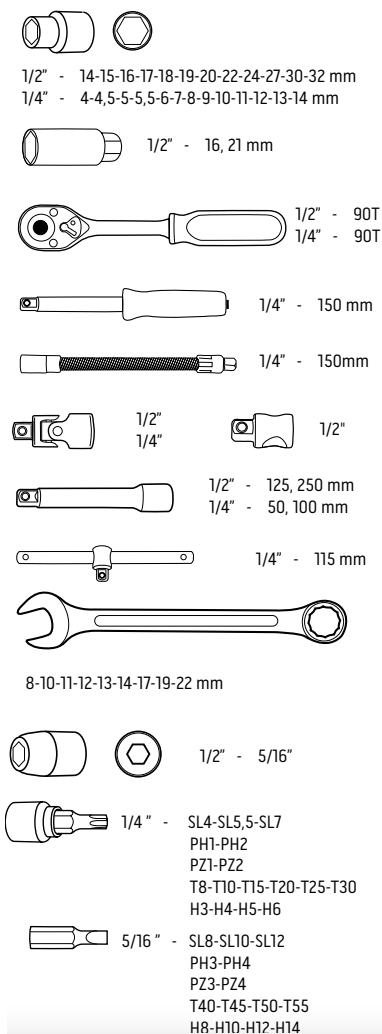

25 years
GUARANTEE



CrV
steel

x82

1/4"

1/2"



PRECISE
4°
90T



82
elements



Ref.	⊞	EAN
10-059	1/4	5907558487695

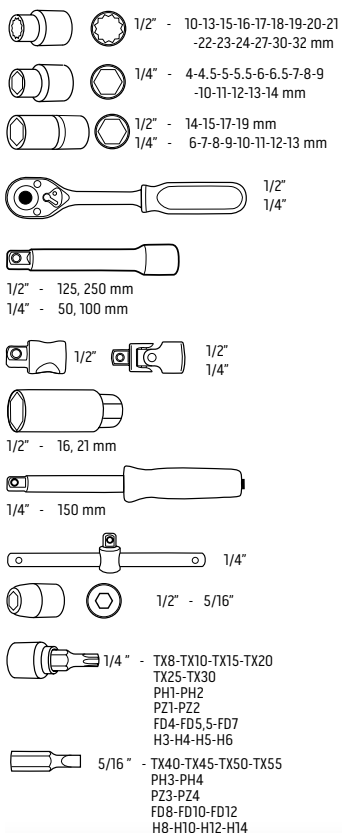

25 years
GUARANTEE



CrV
steel

x86

1/4"

PRECISE
4°
90T

1/2"



86
elements



Ref.	⊞	EAN
10-060	1/4	5907558465976

Klucze nasadowe

Socket wrenches / Steckschlüssel / Набор сменных головок / Ключи торцевой / Dugókulcskészlet / Trusa tubulare / Nástrčné kľúče / Nástrčné ključice / Nasadni ključiči / Veržlerakció antgaliái / Nomaināmo galvu komplekts / Padrinvõtmed / Сменными наконечники за ключовые / Nasadni ključevci / Ključevci natičaki / Σετ με καρδιάκια / Llaves de vaso / Set di bussole SuperLock / Chaves tubulares / Clefs à douilles / Dopsleutels



1/4" - 4-4.5-5-5.5-6-7-8-9-10-11-12-13-14 mm
1/2" - 10-11-12-13-14-15-17-19-20-21-22-24-27 mm

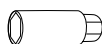

1/2" - 16, 21 mm

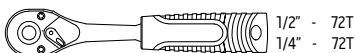

1/2" - 72T
1/4" - 72T

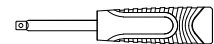

1/4" - 150 mm



1/2" - 125, 250 mm
1/4" - 50, 100 mm

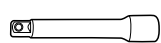

1/2" - 125, 250 mm
1/4" - 50, 100 mm



1/4"

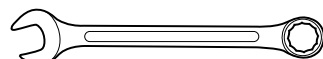

10-11-12-13-14-15-17-19 mm

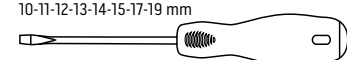

SL 5.5x38mm / SL 6.5x100mm
PH1x38mm / PH2x100mm



1/4"

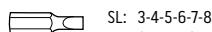

SL: 3-4-5-6-7-8
PH: 0-1-2-2-3
PZ: 0-1-2-2-3
T: 8-10-15-20-25-27-30-40-45
TT: 8-10-15-20-25-27-30-40-45
H: 3-4-5-5.5-6-8

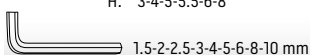

1.5-2-2.5-3-4-5-6-8-10 mm



25 years
GUARANTEE

CrV
steel

100
ELEMENTS

72T

STRONG
CASE

ERGO

+

+

+

+

+

+

+

1/4"

1/2"

72T
1/2"

72T
1/4"

1.5/ 2/ 2.5/ 3/ 4/
5/ 6/ 8/ 10 mm

x8

x4

1/4"



100
elements



Ref.	📦	EAN
10-206	1/3	5907558463224

1/2" - 10-11-12-13-14-15-16-17-18-19
-20-21-22-23-24-27-30-32 mm
1/4" - 4-4.5-5-5.5-6-7-8-9-10
-11-12-13-14 mm

1/2" - 14-15-17-19 mm
1/4" - 6-7-8-9-10-11-12-13 mm



1/2"
1/4"

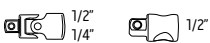

1/2"
1/4"

1/2" - 125, 250 mm
1/4" - 50, 100 mm

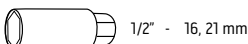

1/2" - 16, 21 mm



1/4"



1/4" - 150 mm

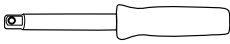

1/4" - 150 mm

1/4" - SL4-SL5.5-SL7
PH1-PH2
PZ1-PZ2
T8-T10-T15-T20-T25-T30
H3-H4-H5-H6

5/16" - SL8-SL10-SL12
PH3-PH4
PZ3-PZ4
T40-T45-T50-T55
H8-H10-H12-H14



1.5-2.5 mm



1/4" - 1/4"



1/2" - 5/16"



25 years
GUARANTEE

TÜV Rheinland
CERTIFIED

CrV
steel

x94

1/4"

1/2"

+

PRECISE
4°
90T

NEW
PATENTED
DESIGN

+

+

+

+

+

+



94
elements



Ref.	📦	EAN
10-062	1/4	5907558465952

Klucze nasadowe

Socket wrenches / Steckschlüssel / Набор сменных головок / Ключи торцевой / Dugókulcskészlet / Trusa tubulara / Nástrčné kľúče / Nástrčné kľúče / Nasadni ključiči / Veržlerakció antgaliai / Nomināmo galvu komplekts / Padrunvõtmed / Сменяемые наконечники за ключовые / Nasadni ključevci / Ključevci natičaki / Set ме карубака / Llaves de vaso / Set di bussole SuperLock / Chaves tubulares / Clefs à douilles / Dopsleutels

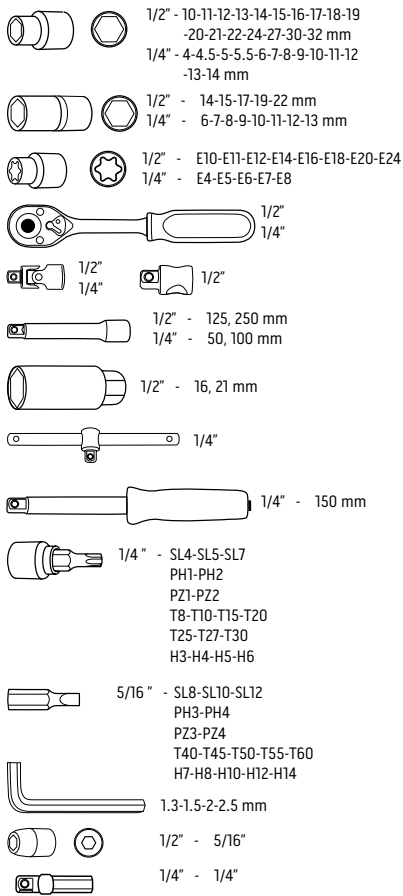

25
years
GUARANTEE



CrV
steel

x110

1/4"

1/2"



PRECISE
4°
90T



110
elements



Ref.	☐	EAN
10-066	1/4	5907558465891



Klucze nasadowe

Socket wrenches / Steckschlüssel / Набор сменных головок / Ключи торцевой / Dugókulcskészlet / Trusa tubulare / Nástrčné kľúče / Nástrčné ključice / Nasadni ključiči / Veržlerakció antgaliái / Nomaināmo galvu komplekts / Padrinvõtmed / Сменная накрайница за ключове / Nasadni ključeviči / Ključeviči natičaki / Σετ με καρδιάκια / Llaves de vaso / Set di bussole SuperLock / Chaves tubulares / Clefs à douilles / Dopsleutels



1/4" - 4-4.5-5-5.5-6-7-8-9-10-11-12-13-14 mm
 3/8" - 10-11-12-13-14-15-16-17-18-19 mm
 1/2" - 10-11-12-13-14-15-17-19-20-21-22-24-27-30-32 mm



25
years
GUARANTEE



216
elements



1/4" - 4-5-6-7-8-9-10 mm
 3/8" - 10-11-12-13-14-15 mm
 1/2" - 16-17-18-19-22 mm



1/4" - E4-E5-E6-E7-E8
 3/8" - E10-E11-E12-E14-E16-E18
 1/2" - E20-E22-E24

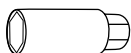

3/8" - 18 mm
 1/2" - 16, 21 mm

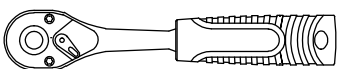

1/4" - 72T 3/8" - 72T 1/2" - 72T



1/4"

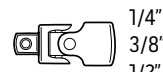

1/4"
3/8"
1/2"

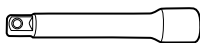

1/4" - 50, 100 mm
 3/8" - 150 mm
 1/2" - 125, 250 mm

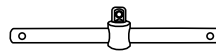

1/4" - 115 mm
 1/2" - 250 mm



1/4" - 1/4"
 3/8" - 5/16"
 1/2" - 5/16"

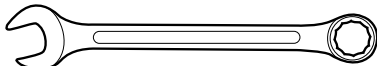

8-10-11-12-13-14-15-16-17-18-19-22 mm

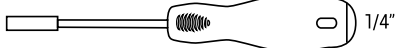

1/4"

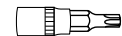

1/2" - T: 55-60
 1/4" - T: 25-27-30-35-40-40-45-50
 TT: 27-30-35-40-45-50
 PH: 3-4
 PZ: 3-4
 SL: 6-6.5-8
 H: 5.5-6-6.5-7-8
 M: 5-6-8-10



1/4"

T: 25-27-30-35-40-45 M: 5-6-8-10
 TT: 27-30-35-40-45 HH: 3-4-5-6
 H: 5.5-6-6.5-7-8 S: 1-2
 PH: 1-2-3 U: 4-6-8
 PZ: 1-2-3 X: 6-8-10
 SL: 6-6.5-8 Y: 1-2-3



5/16"

T: 25-27-30-35-40-40-45-50
 TT: 27-30-35-40-45-50
 H: 5.5-6-6.5-7-8
 PH: 3-4
 PZ: 3-4
 SL: 6-6.5-8
 M: 5-6-8-10



1.27-1.5-2-2.5-3-4-5 mm



Ref.	☒	EAN
10-216	1/2	5907558463255

Klucze nasadowe

Socket wrenches / Steckschlüssel / Набор сменных головок / Ключи торцевые / Dugókulcskészlet / Trusa tubulara / Nástrčné kľúče / Nástrčné klúče / Nasadni ključiči / Veržlerakció angalioi / Nomaināmo galvu komplekts / Padrunģvārdmed / Сменяемыми наконечниками за ключовые / Nasadni ključeviči / Ključeviči natičakāči / Σετ με καρυδάκια / Llaves de vaso / Set di bussolle SuperLock / Chaves tubulares / Clefs à douilles / Dopsleutels



1/2" - 10-11-12-13-14-15-17-19-20-21-22-24-27-30-32 mm
 3/8" - 10-11-12-13-14-15-16-17-18-19 mm
 1/4" - 4-4,5-5-5,5-6-7-8-9-10-11-12-13-14 mm



1/2" - 16-17-18-19-22 mm
 3/8" - 10-11-12-13-14-15 mm
 1/4" - 4-5-6-7-8-9-10 mm



1/2" - E18- E20-E22-E24
 3/8" - E8-E10-E12-E14-E16
 1/4" - E4-E5-E6-E7-E8

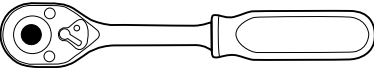

1/2" - 90T; 3/8" - 90T; 1/4" - 90T

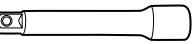

1/2" - 125, 250 mm
 3/8" - 125 mm
 1/4" - 50, 100 mm

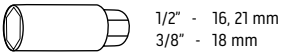

1/2" - 16, 21 mm
 3/8" - 18 mm

219

elements

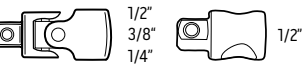

1/2" - 16, 21 mm
 3/8" - 18 mm
 1/4" - 50, 100 mm



1/2" - T55-T60
 1/4" - SL4-SL5.5-SL6.5-SL7
 PZ1-PZ2-PZ3, PH1-PH2-PH3
 T8-T9-T10-T15-T20-T25-T27-T30
 TT8-TT9-TT10-TT15-TT20-TT25-TT27-TT30
 H3-H4-H5-H6

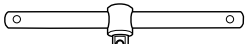

1/4" - 115 mm



1/4" - 210 mm



1/4" - 150 mm



8-9-10-11-12-13-14-15-16-17-18-19 mm



5/16" - T25-T27-T30-T35-T40-T45-T50
 H5.5-H6-H7-H8, SL6-SL6.5-SL8
 PH3-PH4, PZ3-PZ4, M5-M6-M8-M10



1/4" - H3, H4, H5, H6, H3, H4, H5, H6
 PH1, PH2, PZ1, PZ2, T8, T10, T15, T20,
 T25, TT10, TT15, TT20, TT25, TT40,
 TT8, TT10, TT20, TT25, M5, M6,
 M8, SL4, SL5, SL5.5, TRI-WING 1, 2, 3,
 TORQ 6, 8, 10, S1, S2, SL4, SL6, SL8



1/2" - 5/16"
 3/8" - 5/16"
 1/4" - 5/16"



(1,27-1,5-2mm) x 2
 2,5-3-4-5 mm



Ref.	⊞	EAN
10-076	1/2	5907558465907

Klucze nasadowe

Socket wrenches / Steckschlüssel / Набор сменных головок / Ключи торцевые / Dugókulcskészlet / Trusa tubulare / Nástrčné kľúče / Nástrčné kľúče / Nasadni ključji / Veržlerakció antgaliai / Nomaināmo galvu komplekts / Padrīnātmed / Сменная накрайница за ключове / Nasadni ključevi / Ključevi natičaki / Σετ με καρυδάκια / Llaves de vaso / Set di bussole SuperLock / Chaves tubulares / Clefs à douilles / Dopsleutels



1/2" - 10-13-15-16-17-18-19-20-21-22-23-24-27-30-32 mm
 7/16", 1/2", 9/16", 5/8", 11/16", 3/4", 13/16", 7/8"
 3/8" - 10-11-12-13-14-15-16-17-18-19 mm
 1/4" - 3.5-4-4.5-5-5.5-6-6.5-7-8-9-10-11-12-13-14 mm
 3/8", 11/32", 5/16", 9/32", 1/4", 5/32", 3/16"

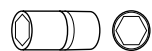

1/2" - 15-16-17-18-19-22 mm
 3/8" - 10-11-12-13-14-15 mm
 1/4" - 4-5-6-7-8-9-10 mm



1/2" - E16-E18-E20-E22-E24
 3/8" - E10-E11-E12-E14
 1/4" - E4-E5-E6-E7-E8

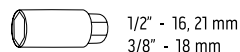

1/2" - 16, 21 mm
 3/8" - 18 mm

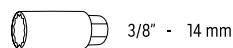

3/8" - 14 mm



1/2" - 125, 250 mm

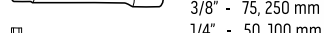

3/8" - 75, 250 mm

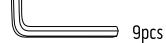

1/4" - 50, 100 mm



9pcs

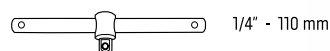

1/4" - 110 mm



1/4"



1/4"



1/4"

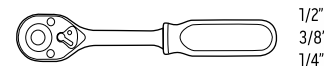

1/2"
 3/8"
 1/4"

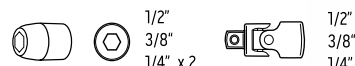

1/2"
 3/8"
 1/4" x 2



1/2"
 3/8"



1/4" x 1/4"
 1/4" x 3/8"

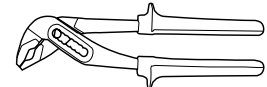

8-9-10-11-12-13-14-15-17-19-22 mm



L=75mm
 8pcs



5/16" L=30mm
 24pcs



L=25mm
 60pcs



233
 elements



Ref.	⊠	EAN
10-078	1/2	5907558465914

Zestaw nasadek

Socket set / Aufsatzset / Набор головок торцевых / Набор насадок торцевых / Dugókulcs készlet / Set duze / Sada násadek / Súprava nástr. klúčov / Garnitura nasadnih ključev / Antgalių rinkinys / Mucipru kompleks / Padrunikomplekt / Тодор компл. / Set nasadnih ključeva / Gedora set / Συλλογή καρδαικιών / Llaves de vasa / Set di boccole / Kit de bicos / Jeu de douilles / Set van messen

1/4" - 4-5-5.5-6-7-8-9-10-11-12-13 mm
3/8" - 10-11-12-13-14-15 -16-17-18-19-21-22-24 mm

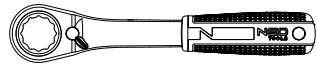

1/4", 72T
3/8", 72T

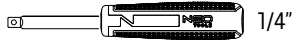

1/4"



1/4"



1/4", 100 mm

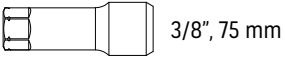

3/8", 75 mm

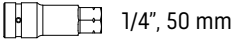

1/4", 50 mm



1/4" 13 mm

3/8" 19 mm

1/2" 19 mm

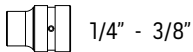

1/4" - 3/8"



1/4"

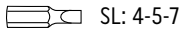

1/4"

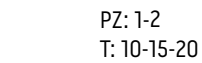

SL: 4-5-7

PH: 1-2

PZ: 1-2

T: 10-15-20



46
elements

25
years
GUARANTEE

CrV
steel

1/4" **3/8"**



Ref.	☒	EAN
10-019	0/5	5907558495782



Klucze nasadowe sześciokątne

Socket wrenches / Steckschlüssel / Набор сменных головок / Ключи торцевые / Dugókulcskészlet / Trusa tubulara / Nástrčné kľúče / Nástrčné kľúče / Nasadni ključiči / Veržlerakció antgaliai / Nomaināto galvu komplekts / Padrunvõrmed / Сменяемы накрайници за ключове / Nasadni ključeviči / Ključeviči patikači / Σετ με καριδάκια / Llaves de vaso / Set di bussola SuperLock / Chaves tubulares / Clefs à douilles / Dopsleutels

25
years
GUARANTEE



CrV
steel

S2
steel

x41

1/4"



1/4" - 5, 5.5, 6, 7, 8, 9, 10, 11, 12, 13, 14 mm



1/4" - 4, 5, 6, 7, 8 mm

PH1, PH2, PH3,
PZ1, PZ3, PZ2x2,
TT8, TT9, TT10, TT15, TT20, TT25,
TT27, TT30, TT40
H2, H2.5, H3, H4, H5, H6, H7, H8

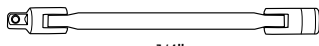

1/4"



Ref.	☒	EAN
08-603	0/20	5907558409307

Nasadka sześciokątne

Hexagonal socket / Sechskanteinsatz / Головка сменная шестигранная / Насадка шестигранная / Dugókulcs / Cheie tubulara hexagonală / Šestihranný nástavec / Šestihranný nástavec / Šestkotni natični nastavek / Šešiakampis antgalis / Sešstūra nomaināta galva / Kuuskantpadrun / Шестозъелна наставка / Šesterokutna kapica / Šestougaona nasadka / Καριδάκι εξήγωνο / Vaso para destornillador hexagonal / Bussola esagonale / Bocal hexagonal / Douille à 6 pans / Zeskant dop

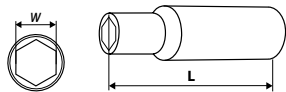

25
years
GUARANTEE

CrV
steel



1/4"



Ref.	W [mm]	L [mm]	☒	EAN
08-487	4	50	25/200	5907558423679
08-488	4.5	50	25/200	5907558423686
08-489	5	50	25/200	5907558423693
08-490	5.5	50	25/200	5907558423709
08-491	6	50	25/200	5907558423716
08-492	7	50	25/200	5907558423723
08-493	8	50	25/200	5907558423730
08-494	9	50	25/200	5907558423747
08-495	10	50	25/200	5907558423754
08-497	12	50	15/150	5907558423778
08-498	13	50	15/150	5907558423785
08-499	14	50	15/150	5907558423792

Nasadka sześciokątne

Hexagonal socket / Sechskanteinsatz / Головка сменная шестигранная / Насадка шестигранная / Dugókulcs / Cheie tubulara hexagonală / Šestihranný nástavec / Šestihranný nástavec / Šestkotni natični nastavek / Šešiakampis antgalis / Sešstūra nomaināta galva / Kuuskantpadrun / Шестозъелна наставка / Šesterokutna kapica / Šestougaona nasadka / Καριδάκι εξήγωνο / Vaso para destornillador hexagonal / Bussola esagonale / Bocal hexagonal / Douille à 6 pans / Zeskant dop

25
years
GUARANTEE



CrV
steel

1/4"



DIN
3124

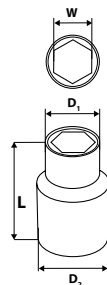

Ref.	W [mm]	L [mm]	D ₁ [mm]	D ₂ [mm]	☒	EAN
08-220	4	25	7	12	100/500	5907558403787
08-221	4.5	25	7.5	12	100/500	5907558403794
08-222	5	25	8	12	25/200	5907558403800
08-223	5.5	25	8.5	12	25/200	5907558403817
08-224	6	25	9	12	100/200	5907558403824
08-225	7	25	10.5	12	25/200	5907558403831
08-226	8	25	12	12	25/200	5907558403848
08-227	9	25	13	13	50/500	5907558403855
08-228	10	25	14	14	25/200	5907558403862
08-229	11	25	16	16	50/500	5907558403879
08-230	12	25	17	17	15/150	5907558403886
08-231	13	25	18	18	15/150	5907558403893
08-232	14	25	20	20	50/500	5907558403909

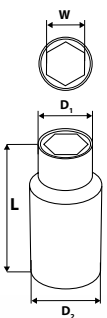

Ref.	W [mm]	L [mm]	D ₁ [mm]	D ₂ [mm]	☒	EAN
08-235	4	50	7	12	50/500	5907558412055
08-236	4.5	50	7.5	12	50/500	5907558412062
08-237	5	50	8	12	50/500	5907558412079
08-238	5.5	50	8.5	12	50/500	5907558412086
08-239	6	50	9	12	50/500	5907558412093
08-240	7	50	10.5	12	25/200	5907558412109
08-241	8	50	12	12	50/200	5907558412116
08-242	9	50	13	13	50/200	5907558412123
08-243	10	50	14	14	25/200	5907558412130
08-244	11	50	16	16	50/150	5907558412147
08-245	12	50	17	17	50/300	5907558412154
08-246	13	50	18	18	50/150	5907558412161
08-247	14	50	20	20	50/150	5907558412178

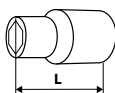

25
years
GUARANTEE

CrV
steel



1/4"



Ref.	W [mm]	L [mm]	☒	EAN
08-442	4	25	25/200	5907558423280
08-443	4.5	25	25/200	5907558423297
08-444	5	25	25/200	5907558423303
08-446	6	25	25/200	5907558423327
08-447	7	25	25/200	5907558423334
08-448	8	25	25/200	5907558423341
08-449	9	25	25/200	5907558423358
08-450	10	25	25/200	5907558423365
08-451	11	25	15/150	5907558423372
08-452	12	25	15/150	5907558423389
08-453	13	25	15/150	5907558423396
08-454	14	25	15/150	5907558423402

Nasadka sześciokątna

Hexagonal socket / Sechskanteinsatz / Головка сменная шестигранная / Насадка шестигранна / Dugókulcs / Cheie tubulara hexagonala / Šestihránný nástavec / Šesthranný nástavec / Šestkotni natični nastavek / Šešakampis antgalis / Sešstūra nomaināmā galva / Kuuskantpradrin / Шестъгълна наставка / Šesterokutna kapica / Šestougaona nasadka / Καρυδάκι εξαγώνο / Vaso para destornillador hexagonal / Bussola esagonale / Bocal hexagonal / Douille à 6 pans / Zeskant dop

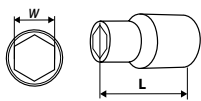

Ref.	W [mm]	L [mm]	☒	EAN
08-168	8	30	20/200	5907558422757
08-170	10	30	20/200	5907558422764
08-171	11	30	20/200	5907558422771
08-172	12	30	20/200	5907558422788
08-173	13	30	20/200	5907558422795
08-174	14	30	20/200	5907558422801
08-175	15	30	20/200	5907558422818
08-176	16	30	20/200	5907558422825
08-177	17	30	20/200	5907558422832
08-178	18	30	20/200	5907558422849
08-179	19	30	20/200	5907558422856
08-180	20	30	20/200	5907558422863
08-181	21	30	20/200	5907558422870
08-182	22	30	20/200	5907558422887

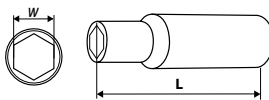

Ref.	W [mm]	L [mm]	☒	EAN
08-184	8	63	20/200	5907558422894
08-185	10	63	20/200	5907558422900
08-186	11	63	20/200	5907558422917
08-187	12	63	20/200	5907558422924
08-188	13	63	20/200	5907558422931
08-189	14	63	20/200	5907558422948
08-190	15	63	20/200	5907558422955
08-191	16	63	20/200	5907558422962
08-192	17	63	20/200	5907558422979
08-193	18	63	20/200	5907558422986
08-194	19	63	20/200	5907558422993
08-195	20	63	20/100	5907558423006
08-196	21	63	20/100	5907558423013
08-197	22	63	20/100	5907558423020

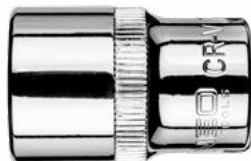
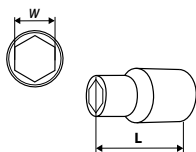

Ref.	W [mm]	L [mm]	☒	EAN
08-408	8	38	20/200	5907558423037
08-409	9	38	20/200	5907558423044
08-410	10	38	20/200	5907558423051
08-411	11	38	20/200	5907558423068
08-412	12	38	20/200	5907558423075
08-413	13	38	20/200	5907558423082
08-414	14	38	20/200	5907558423099
08-415	15	38	20/200	5907558423105
08-416	16	38	20/200	5907558423112
08-417	17	38	20/200	5907558423129
08-418	18	38	20/200	5907558423136
08-419	19	38	20/200	5907558423143
08-421	21	38	20/200	5907558423167
08-422	22	38	20/200	5907558423174
08-423	23	38	20/200	5907558423181
08-424	24	38	20/200	5907558423198
08-425	25	38	10/100	5907558423204
08-426	26	42	10/100	5907558423211
08-427	27	42	10/100	5907558423228
08-429	29	44	10/100	5907558423242
08-430	30	44	10/100	5907558423259
08-431	31	44	10/100	5907558423266
08-432	32	44	10/100	5907558423273

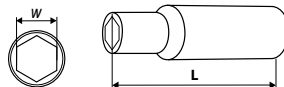
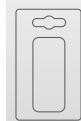

Ref.	W [mm]	L [mm]	☒	EAN
08-458	8	77	20/200	5907558423419
08-459	9	77	20/200	5907558423426
08-460	10	77	20/200	5907558423433
08-461	11	77	20/200	5907558423440
08-462	12	77	20/200	5907558423457
08-463	13	77	20/200	5907558423464
08-464	14	77	20/200	5907558423471
08-465	15	77	20/200	5907558423488
08-466	16	77	20/200	5907558423495
08-467	17	77	20/200	5907558423501
08-468	18	77	20/200	5907558423518
08-469	19	77	20/200	5907558423525
08-470	20	77	20/100	5907558423532
08-471	21	77	20/100	5907558423549
08-472	22	77	20/100	5907558423556
08-473	23	77	20/100	5907558423563
08-474	24	77	20/100	5907558423570
08-475	25	77	10/50	5907558423587
08-476	26	77	10/50	5907558423594
08-477	27	77	10/50	5907558423600
08-478	28	77	10/50	5907558423617
08-479	29	77	10/50	5907558423624
08-480	30	77	10/50	5907558423631
08-482	32	77	10/50	5907558423655
08-486	36	77	4/40	5907558423662



Nasadka sześciokątna

Hexagonal socket / Sechskanteinsatz / Головка сменная шестигранная / Nasadka szesciokątna / Dugókulcs / Cheie tubulara hexagonală / Šestihranný nástavec / Šesthranný nástavec / Šestkotni natični nastavek / Sešikampis antgalis / Sešstūra nomaināma galva / Kuuskantpadrun / Шестьугольная наставка / Šesterokutna kapica / Šestougaona nasadka / Καρυβάκι εξήγωνα / Vaso para destornillador hexagonal / Bussola esagonale / Bocal hexagonal / Douille à 6 pans / Zeskant dop

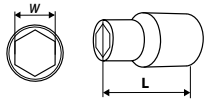

25 years
GUARANTEE



CrV
steel

1/2"



DIN
3124

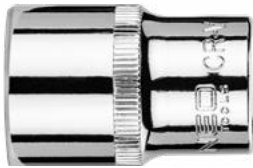

Ref.	W [mm]	L [mm]	☒	EAN
08-008	8	38	20/200	5907558403503
08-009	9	38	20/200	5907558403510
08-010	10	38	20/100	5907558402353
08-011	11	38	20/100	5907558403527
08-012	12	38	20/100	5907558402360
08-013	13	38	20/200	5907558402377
08-014	14	38	20/100	5907558408232
08-015	15	38	20/200	5907558402384
08-016	16	38	20/200	5907558403534
08-017	17	38	20/200	5907558402391
08-018	18	38	20/200	5907558403541
08-019	19	38	20/200	5907558402407
08-020	20	38	10/100	5907558412451
08-021	21	38	20/200	5907558403558
08-022	22	38	20/200	5907558402414
08-023	23	38	10/100	5907558412468
08-024	24	38	20/100	5907558402421
08-025	25	38	10/100	5907558412475
08-026	26	42	10/100	5907558403565
08-027	27	42	10/100	5907558402438
08-028	28	42	10/100	5907558403572
08-029	29	44	10/100	5907558403589
08-030	30	44	10/100	5907558402445
08-032	32	44	10/100	5907558402452
08-036	36	44	10/0	5907558403602

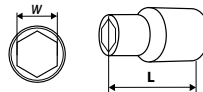

25 years
GUARANTEE



CrV
steel

3/8"



DIN
3124



Ref.	W [mm]	L [mm]	☒	EAN
08-300	19	51	10/80	5907558404180
08-301	21	51	10/100	5907558410600
08-302	22	51	10/80	5907558404197
08-304	24	51	10/100	5907558404203
08-306	27	52	10/80	5907558404210
08-307	28	52	10/60	5907558412543
08-308	30	54	10/60	5907558404227
08-309	32	56	10/60	5907558404234
08-316	34	56	10/60	5907558410624
08-319	35	57	10/60	5907558412567
08-311	36	59	10/40	5907558404241
08-312	38	60	10/40	5907558404258
08-313	41	64	10/40	5907558404265
08-314	46	68	10/20	5907558404272
08-315	50	72	10/20	5907558404289
08-340	55	76	10/20	5907558412574
08-341	60	78	10/20	5907558412581



Nasadka dwunastokątna

Bi-hexagonal socket / Zwölfkanteinsatz / Головка сменная двенадцатигранная / Nasadka dwanaściamiętrna / Dugókulcs 12 pontos / Cheie tubulară, priză în 12 pute / Dvanástihranný nástavec / Dvanajstkotni nasadni ključ / Dvylikakampis antgalis / Divpadsmitstūra nomaināma galva / Kaksteistkantpadrun / Дванадесетьугольная наставка / Dvanaesterokutna kapica / Dvanaestougaona nasadka / Καρυβάκι δωδεκάγωνα / Vaso destornillador de encaje dodecagonal / Bussola Spline / Bocal de doze ângulos / Douille à 12 pans / Twaalfkant dop

25 years
GUARANTEE



CrV
steel

1/2"



DIN
3124

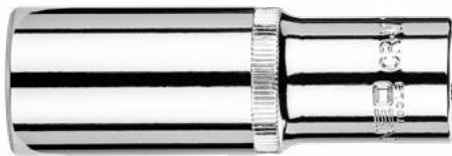
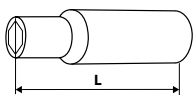

Ref.	W [mm]	L [mm]	☒	EAN
08-039	8	77	12/144	5907558410501
08-040	9	77	20/200	5907558410518
08-041	10	77	20/200	5907558402469
08-052	11	77	20/176	5907558410525
08-042	12	77	20/200	5907558402476
08-043	13	77	20/200	5907558402483
08-053	14	77	20/176	5907558410532
08-044	15	77	20/200	5907558402490
08-054	16	77	12/144	5907558410549
08-045	17	77	20/200	5907558402506
08-055	18	77	20/96	5907558410556
08-046	19	77	20/200	5907558402513
08-056	21	77	6/96	5907558410563
08-047	22	77	6/96	5907558402520
08-058	23	77	6/72	5907558412499
08-048	24	77	6/72	5907558402537
08-049	27	77	10/100	5907558402544
08-050	30	77	10/50	5907558402551
08-051	32	77	6/48	5907558402568

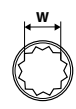
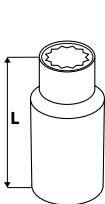

25 years
GUARANTEE



CrV
steel

1/2"



DIN
3124



Ref.	W [mm]	L [mm]	☒	EAN
08-070	10	77	8/200	5907558405613
08-086	11	77	12/144	5907558410594
08-071	12	77	20/200	5907558405620
08-072	13	77	12/200	5907558405637
08-073	14	77	20/200	5907558408249
08-074	15	77	12/144	5907558405644
08-075	16	77	20/200	5907558406078
08-076	17	77	20/200	5907558405651
08-077	18	77	6/96	5907558406085
08-078	19	77	6/96	5907558405668
08-080	21	77	6/96	5907558408256
08-081	22	77	6/120	5907558405675
08-082	24	77	6/72	5907558405682
08-083	27	77	6/72	5907558405699
08-084	30	77	10/50	5907558405705
08-085	32	77	6/948	5907558405712



Nasadka dwunastokątna

Bi-hexagonal socket / Zwölfkanteinsatz / Головка сменная двенадцатигранная / Насадка дванадцатигранная / Dugökülcs 12 pontos / Cheie tubulara, priza in 12 pute / Dvanáctihřanný nástavec / Dvanáštřhřanný nástavec / Dvanajstkotni nasadni ključ / Dvilykakampis antgalis / Divpadsmitstūra pomašināma galva / Kaksteistkantpadrūn / Дванадцетъгълна наставка / Dvanaesterokutna kapica / Dvanaestougaona nasadka / Καρυδιά / δωδεκάγωνο / Vaso destornillador de encaje dodecagonal / Bussola Spline / Bocal de doze ângulos / Douille à 12 pans / Twaalfkant dop

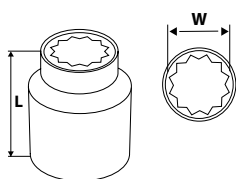

25
years
GUARANTEE



CrV
steel

3/8"

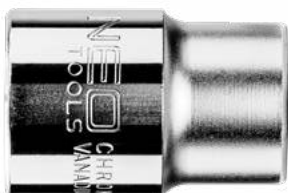

Ref.	W [mm]	L[mm]	⊠	EAN
08-320	19	50	10/80	5907558406108
08-333	21	52	10/80	5907558410631
08-321	22	50	10/80	5907558406115
08-322	24	51	10/80	5907558406122
08-323	27	52	10/80	5907558406139
08-324	30	54	10/60	5907558406146
08-325	32	56	10/60	5907558406153
08-335	34	56	10/60	5907558410655
08-326	36	58	10/60	5907558406160
08-327	38	60	10/40	5907558406177
08-328	41	64	10/40	5907558406184
08-329	46	68	10/20	5907558406191
08-331	55	76	10/20	5907558406214
08-332	60	79	10/20	5907558406221

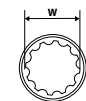

25
years
GUARANTEE



CrV
steel



x8

1/2"



MM	10	12	13	15	17	19	22	24
INCH	3/8	15/32	1/2	19/32		3/4	7/8	15/16
STAR	E12	E16				E24		

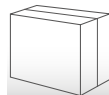

Ref.	W [mm]	⊠	EAN
08-651	10,12,13,15,17,19,22,24	0/30	5907558406290

25
years
GUARANTEE



CrV
steel

1/2"



DIN
3124

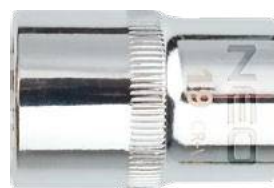
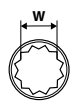
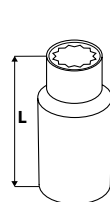

Ref.	W [mm]	L[mm]	⊠	EAN
08-580	8	38	10/200	5907558408263
08-581	9	38	10/100	5907558408270
08-582	10	38	20/100	5907558408287
08-583	11	38	10/100	5907558408294
08-584	12	38	10/100	5907558408300
08-585	13	38	10/200	5907558408317
08-586	14	38	10/200	5907558408324
08-587	15	38	10/100	5907558408331
08-588	16	38	10/200	5907558408348
08-589	17	38	10/200	5907558408355
08-590	18	38	10/200	5907558408362
08-591	19	38	10/100	5907558408379
08-592	20	38	10/100	5907558408386
08-593	21	38	10/100	5907558408393
08-594	22	38	10/100	5907558408409
08-595	23	38	10/100	5907558412505
08-596	24	38	10/200	5907558408416
08-597	27	42	10/100	5907558408423
08-598	30	44	10/100	5907558408430
08-599	32	44	10/100	5907558408447

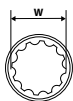

25
years
GUARANTEE



CrV
steel



x8

1/2"



MM	10	12	13	15	17	19	22	24
INCH	3/8	15/32	1/2	19/32		3/4	7/8	15/16
STAR	E12	E16				E24		

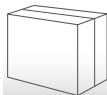

Ref.	W [mm]	m[kg]	⊠	EAN
08-650	10,12,13,15,17,19,22,24	1,1	0/20	5907558406283

Grzechotka

Ratchet handle / Ratsche / Трещотка / Держак з трісноткою / Racsnikulcs / Miner de hurluitoare / Рѣнтачка / Račňa prepinacia / Raglja / Terkšlė / Reversa atslėga / Põrktratta pide / Трещотка / Račva za nasadni ključ / Račva za gedoru / Καρυδιά / Llave de carraca / Cricchetto / Catraca de furar / Clé à cliquet / Roteel



25
years
GUARANTEE



CrV
steel

CrMo
steel

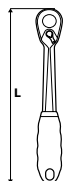

25
years
GUARANTEE



CrV
steel

CrMo
steel



DIN
3122



Ref.	Info	L[mm]	⊠	EAN
10-300	1/2"	285	1/10	5907558467338



Ref.	Info	L[mm]	⊠	EAN
08-530	1/4"	155	10/50	5907558435689
08-533	3/8"	200	5/25	5907558435696
08-536	1/2"	250	5/20	5907558435702

Grzechotka

Ratchet handle / Ratsche / Трещотка / Держак з тріскоткою / Racsnikulcs / Mîner de hurluitoare / Řehtačka / Račna prepínacia / Raglja / Terkslê / Reversa atslêga / Põrkkratta pide / Трещотка / Račva za nasadni ključ / Račva za gedoru / Κατασπία / Llave de carraca / Cricchetto / Catraca de furar / Clé à cliquet / Rate!



25 years GUARANTEE

TÜVRheinland CERTIFIED

CrV steel

CrMo steel

72

DIN 3122

Ref.	Info	L[mm]	☒	EAN
08-540	1/4"	155	5/50	5907558435719
08-543	3/8"	200	5/25	5907558435726
08-546	1/2"	250	5/20	5907558435733



25 years GUARANTEE

TÜVRheinland CERTIFIED

CrV steel

48

DIN 3122

Ref.	Info	L[mm]	☒	EAN
08-504	1/4"	150	10/50	5907558420708
08-508	3/8"	210	6/48	5907558420715
08-521	1/2"	265	5/25	5907558420722



25 years GUARANTEE

CrV steel

45

DIN 3122

Ref.	Info	L[mm]	☒	EAN
08-523	1/4"	155	6/72	5907558432190
08-524	3/8"	200	6/48	5907558432206
08-525	1/2"	250	6/36	5907558432213



25 years GUARANTEE

TÜVRheinland CERTIFIED

CrV steel

CrMo steel

72

DIN 3122

Ref.	Info	Lmin[mm]	Lmax[mm]	☒	EAN
08-502	1/4"	150	200	10/50	5907558412802
08-515	1/2"	305	445	0/25	5907558408546



25 years GUARANTEE

TÜVRheinland CERTIFIED

CrV steel

CrMo steel

72

1/2"

DIN 3122

Ref.	Info	L[mm]	☒	EAN
08-519	1/2"	285	0/24	5907558410167



25 years GUARANTEE

TÜVRheinland CERTIFIED

CrV steel

CrMo steel

72

DIN 3122

Ref.	Info	L[mm]	☒	EAN
08-503	1/4"	145	10/50	5907558412819
08-507	3/8"	195	5/60	5907558412833
08-520	1/2"	255	5/25	5907558412840



25 years GUARANTEE

TÜVRheinland CERTIFIED

CrV steel

CrMo steel

72

PP POLYPROPYLEN

DIN 3122

Ref.	Info	L[mm]	☒	EAN
08-514	1/4"	150	12/72	5907558406276
08-513	3/8"	200	12/48	5907558406269
08-511	1/2"	250	0/24	5907558402605



25 years GUARANTEE

TÜVRheinland CERTIFIED

CrV steel

48

1/2"

DIN 3122

Ref.	Info	L[mm]	☒	EAN
08-516	1/2"	255	6/24	5907558409291



25 years GUARANTEE

TÜVRheinland CERTIFIED

CrV steel

CrMo steel

24

3/8"

DIN 3122

Ref.	Info	L[mm]	☒	EAN
08-355	3/4"	500	0/16	5907558404449



25 years GUARANTEE

TÜVRheinland CERTIFIED

CrV steel

CrMo steel

48

DIN 3122

Ref.	Info	L[mm]	☒	EAN
08-512	1/4"	105	10/60	5907558403305



25 years GUARANTEE

TÜVRheinland CERTIFIED

CrV steel

CrMo steel

1/4"

72

DIN 3122

Ref.	Info	L[mm]	☒	EAN
08-501	1/4"	105	10/100	5907558412185

Pokrętko

Wheel / Drehknopf / Вороток / Маховик / Hajtókár / Clupá / Otočný knoflík / Ovládacie koliesko / Raglja / Rankena / Grietzuvite / Nurrp / Върток / Kotačiči / Ručica / Πόμολο / Mango / Impugnatura a L / Botão / Tourne-à-gauche / Драаќнок



Ref.	Info	L[mm]	⊠	EAN
08-947	1/2"	610	20/200	5906692015481

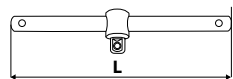

Ref.	Info	L[mm]	⊠	EAN
08-256	1/4"	110	20/200	5907558403961
08-155	3/8"	165	20/100	5907558403770
08-555	1/2"	250	5/25	5907558402650
08-353	3/4"	460	10/10	5907558404425

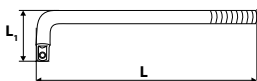

Ref.	Info	L[mm]	L ₁ [mm]	⊠	EAN
08-556	1/2"	250	75	0/40	5907558408607
08-357	3/4"	450	110	0/10	5907558405873



Przedłużka

Extension bar / Verlängerung / Удлинитель / Подовжувач / Toldósár / Prelungitor / Prodlužovák / Predĺženie / Podaljšek / Ilgkiklis / Pagarinātājs / Piekendsvarrags / Удължител / Produziena roluģa / Προέκταση / Alargadera / Prolunga / Extensão / Prolongation / Verlengstuck

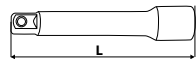

Ref.	L[mm]	Info	⊠	EAN
08-251	50	1/4"	20/200	5907558403916
08-252	75	1/4"	20/200	5907558403923
08-253	100	1/4"	25/50	5907558403930
08-254	150	1/4"	25/50	5907558403947
08-151	75	3/8"	20/200	5907558403732
08-152	125	3/8"	20/200	5907558403749
08-153	150	3/8"	20/100	5907558403756
08-552	125	1/2"	10/50	5907558402636
08-554	250	1/2"	10/50	5907558402643
08-350	100	3/4"	10/40	5907558404296
08-351	200	3/4"	10/20	5907558404302
08-352	400	3/4"	0/10	5907558404418



Przedłużka elastyczna
Flexible extension
Удлинитель гибкий



Ref.	□	L[mm]	M _{0max} [Nm]	⊠	EAN
08-557	1/4"	140	5	25/100	5907558402667
08-558	1/2"	190	40	10/80	5907558402674



Rękojeść z przegubem

Flex handle / Handgriff mit Gelenk / Вороток / Рукюя з шарніром / Hajtókár flexibilis / Maner cu articulație / Kloubové vratidlo / Kĺbová rukoväť / Ročaj z zglobom / Rankena su lankstu / Pagarinātājs mucipnatslēgai / Liigendiga käepide / Ръкохватка с шарнир / Drška sa zglobom / Drška sa zglobom / Μανέλα αλυσθαινούσα / Mango con articulación / Impugnatura telescopica / Cabo com Articulação / Poignée articulée / Handvat met spilverbinding

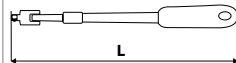

Ref.	L _{min} [mm]	L _{max} [mm]	⊠	EAN
08-553	470	620	5/20	5907558409598

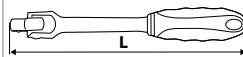

Ref.	L[mm]	⊠	EAN
08-559	250	10/40	5907558403367
08-560	450	10/20	5907558403374

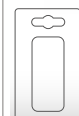
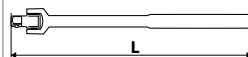

Ref.	L[mm]	⊠	EAN
08-356	510	0/10	5907558404456

Przegub

Articulated joint / Gelenk / Шарнир / Сустав / Kardáncsukló / Articulație / Kloub / Čap / Zglob / Lankstas / Šarnirs / Klamber / Шарнир / Zglob / Zglob / Μεντεσές / Articulación / Giunto articolato / Articulação / Articulation / Spilverbinding



Ref.	Info	L[mm]	⊠	EAN
08-255	1/4"	35	50/400	5907558403954
08-154	3/8"	50	50/400	5907558403763
08-551	1/2"	65	10/80	5907558402629

Redukcja / Adapter

Adaptor / Reduzierstück / Переходник / Перехідник / Adapter / Adaptor / Redukce / Redukcia / Adapter / Adapteris / Päreja / Адаптор / Adapter / Προσαρμογέας / Adaptador / Adattatore / Redução / Réduction / Reductiestuck



Ref.	Info	L[mm]	⊠	EAN
08-562	1/4" M x 3/8" F	26	10/100	5907558403329
08-563	3/8" M x 1/2" F	37	10/100	5907558403336
08-565	1/2" M x 3/4" F	50	40/40	5907558403350
08-564	3/4" M x 1/2" F	46	10/100	5907558403343
08-550	1/2" M x 3/8" F	27	25/200	5907558402612

Końcówka Spline na nasadce

Spline bit / Spline-Endstück / Наконечник Spline / Наконечник „Spline” / Spline bit / Punct Spline / Nástavec Spline / Nástavec Spline / Nástavec Spline / Antgalis Spline / Uzgalis Spline / Spline-otsak / Накрайник Spline / Nastavak Spline / Nastavak Spline / Μύτη Spline / Punta Spline / Inserto Spline su bussola / Ponteiro Spline / Embout Spline / Spline eindstuk



Ref.	Info	L[mm]	☒	EAN
08-730	M5	55	12/144	5907558411911
08-731	M6	55	12/144	5907558411928
08-732	M8	55	12/144	5907558411935
08-733	M10	55	12/144	5907558411942
08-734	M12	55	12/160	5907558411959
08-735	M14	55	12/160	5907558411966
08-736	M16	55	12/144	5907558411973

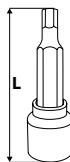

Ref.	Info	L[mm]	☒	EAN
08-740	M5	100	12/96	5907558411980
08-741	M6	100	12/96	5907558411997
08-742	M8	100	12/96	5907558412000
08-743	M10	100	12/96	5907558412017
08-744	M12	100	12/96	5907558412024
08-745	M14	100	12/96	5907558412031
08-746	M16	100	12/96	5907558412048



Końcówka na nasadce

Bit on socket / Einsatz auf Aufsatz / Головка сменная с насадкой / Наконечник на насадці / Bit / Cap tubulara cu antrenor / Koncovka na nástavce / Koncovka na nástavce / Nástavec za nasadni ključ / Torcinis antgalis su laikikliu / Nomaināta galva ar uzgali / Otsak radrunil / Накрайник на наставката / Nastavak na kapici / Nastavak za nasadke / Καρυδάκι με μύτη / Vaso / Inserto con bussola / Ponteiros no bico / Embouts sur ajutage / Eindstuk op dop



Ref.	Info	L[mm]	☒	EAN
10-316	PH1	37	20/200	5907558471243
10-317	PH2	37	20/200	5907558471250
10-318	PH3	37	20/200	5907558471267
10-319	PZ1	37	20/200	5907558471274
10-320	PZ2	37	20/200	5907558471281
10-321	PZ3	37	20/200	5907558471298

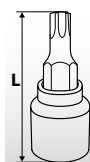

Ref.	Info	L[mm]	☒	EAN
10-334	PH1	87	30/300	5907558471427
10-335	PH2	87	30/300	5907558471434
10-336	PH3	87	30/300	5907558471441
10-337	PZ1	87	30/300	5907558471458
10-338	PZ2	87	30/300	5907558471465
10-339	PZ3	87	30/300	5907558471472

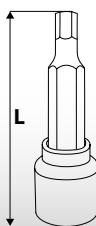

Końcówki sześciokątne na nasadce

Hexagonal bits on socket / Sechskanteinsätze auf Aufsatz / Головки шестигранные с насадкой / Наконечники шестигранні на насадці / Imbusz bit / Trusa capete tubulare cu antrenor / Koncovky šestihranné na nástavce / Šestihranné koncovky na nástavce / Šestkotni nastavki za nasadni ključ / Šešiakantpiai antgaliai su laikikliu / Nomaināta galva ar sešstūra uzgāļiem / Kuuskantotsakud radrunil / Шестогълни накрайници на наставката / Šesterokutni nastavci na kapici / Šestougona nastavci za nasadke / Καρυδάκι με μύτες εξαγώνες / Vasos destormilladores hexagonales / Inserto esagonale con bussola / Ponteiros hexagonais na bico / Embouts à 6 pans sur ajutage / Zeskant eindstukken op dop



Ref.	Info	L[mm]	☒	EAN
10-310	H3	37	20/200	5907558471182
10-311	H4	37	20/200	5907558471199
10-312	H5	37	20/200	5907558471205
10-313	H6	37	20/200	5907558471212
10-314	H7	37	20/200	5907558471229
10-315	H8	37	20/200	5907558471236

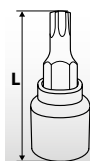

Ref.	Info	L[mm]	☒	EAN
10-329	H4	87	30/300	5907558471373
10-330	H5	87	30/300	5907558471380
10-331	H6	87	30/300	5907558471397
10-332	H7	87	30/300	5907558471403
10-333	H8	87	30/300	5907558471410

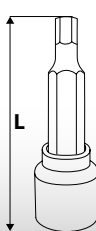

Ref.	Info	L[mm]	☒	EAN
08-770	H5	55	20/140	5907558409765
08-771	H6	55	12/144	5907558409772
08-772	H7	55	20/160	5907558409789
08-773	H8	55	12/144	5907558409796
08-774	H10	55	20/160	5907558409802
08-775	H12	55	20/160	5907558409819
08-776	H14	55	20/160	5907558409826
08-777	H17	55	20/160	5907558409833
08-778	H19	55	12/96	5907558409840

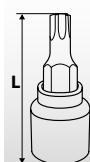

Ref.	Info	L[mm]	☒	EAN
08-780	H5	100	12/96	5907558409857
08-781	H6	100	20/100	5907558409864
08-782	H7	100	12/96	5907558409871
08-783	H8	100	20/100	5907558409888
08-784	H10	100	20/100	5907558409895

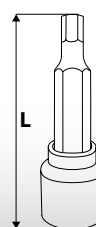

Końcówki sześciokątne na nasadce

Hexagonal bits on socket / Sechskanteinsätze auf Aufsatz / Головки шестигранные с насадкой / Наконечники шестигранны на насадці / Imbusz bit / Trusa capete tubulare cu antrenor / Koncovky šestihranné na nástavce / Šesthranné koncovky na nástavce / Šestkotni nastavki za nasadni ključ / Šešiakampriai antgaliai su laikikliu / Normainānā galva ar sešstūra uzgaļiem / Kuuskantotsakud padrunil / Шестоъгълни накрайници на наставката / Šesterokutni nastavci na kapici / Šestougaoni nastavci za nasadke / Καρυδάκι με μύτες εξάγωνες / Vasos destornilladores hexagonales / Inserto esagonal con bussola / Ponteiros hexagonais no bico / Embouts à 6 pans sur ajutage / Zeskant eindstukken op dop

H4, H5, H6, H7, H8, H10, H12, H14, H17

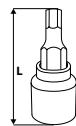

Ref.	L[mm]	☒	EAN
08-705	55	0/12	5907558409253

25 years
GUARANTEE

TÜVRheinland
CERTIFIED

S2
steel

CrV
steel

1/2"

x9



H4, H5, H6, H7, H8, H10, H12, H14, H17

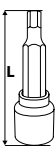

Ref.	L[mm]	☒	EAN
08-706	100	0/12	5907558409260

25 years
GUARANTEE

TÜVRheinland
CERTIFIED

S2
steel

CrV
steel

1/2"

x9



Końcówki Torx na nasadce

Torx bit on socket / Torx-Einsatz auf Aufsatz / Головка сменная с насадкой Torx / Наконечник «Торх» на насадці / Torx bit / Cap tubulara cu antrenor torx / Koncovka Torx na nástavce / Koncovka Torx na nástavce / Nastavek Torx za nasadni ključ / Torcinis antgalis su laikikliu / Normainānā galva ar Torx uzgali / Torx-otsak padrunil / Накрайник Torx на наставката / Nastavak Torx na kapici / Nastavak Torx za nasadke / Καρυδάκι με μίτη Torx / Vaso torx / Inserto Torx con bussola / Ponteiros Torx no bico / Embouts Torx sur ajutage / Trox eindstuk op dop

25 years
GUARANTEE

S2
steel

CrV
steel

1/4"

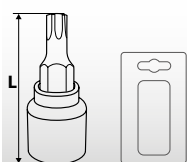

Ref.	Info	L[mm]	☒	EAN
10-322	T10	37	20/200	5907558471304
10-323	T15	37	20/200	5907558471311
10-324	T20	37	20/200	5907558471328
10-325	T25	37	20/200	5907558471335
10-326	T27	37	20/200	5907558471342
10-327	T30	37	20/200	5907558471359
10-328	T40	37	20/200	5907558471366

25 years
GUARANTEE

S2
steel

CrV
steel

1/4"

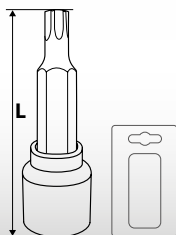

Ref.	Info	L[mm]	☒	EAN
10-340	T10	87	30/300	5907558471489
10-341	T15	87	30/300	5907558471496
10-342	T20	87	30/300	5907558471502
10-343	T25	87	30/300	5907558471519
10-344	T27	87	30/300	5907558471526
10-345	T30	87	30/300	5907558471533
10-346	T40	87	30/300	5907558471540

25 years
GUARANTEE

TÜVRheinland
CERTIFIED

S2
steel

CrV
steel

1/2"

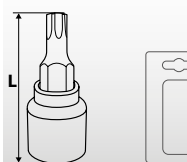

Ref.	Info	L[mm]	☒	EAN
08-750	T20	55	12/144	5907558409604
08-751	T25	55	12/144	5907558409611
08-752	T27	55	12/144	5907558409628
08-753	T30	55	12/144	5907558409635
08-754	T40	55	20/160	5907558409642
08-755	T45	55	20/160	5907558409659
08-756	T50	55	12/144	5907558409666
08-757	T55	55	20/160	5907558409673
08-758	T60	55	12/144	5907558417388
08-759	T70	55	12/144	5907558417395

25 years
GUARANTEE

TÜVRheinland
CERTIFIED

S2
steel

CrV
steel

1/2"

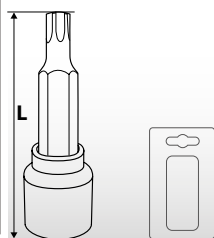

Ref.	Info	L[mm]	☒	EAN
08-760	T20	100	12/96	5907558409680
08-761	T25	100	20/100	5907558409697
08-762	T27	100	20/100	5907558409703
08-763	T30	100	20/100	5907558409710
08-764	T40	100	12/96	5907558409727
08-765	T45	100	20/100	5907558409734
08-766	T50	100	20/100	5907558409741
08-767	T55	100	20/100	5907558409758

Końcówki Torx na nasadce

Torx bit on socket / Torx-Einsatz auf Aufsatz / Головка сменная с насадкой Torx / Наконечник «Torx» на насадке / Torx bit / Cap tubulara cu antrenor torx / Koncovka Torx na nástavce / Koncovka Torx na nástavce / Nastavek Torx za nasadni ključ / Torcinis antgališ su laikikliu / Nomaināma galva ar Torx uzgali / Torx-otsak padrunil / Накрайник Torx на наставката / Nastavak Torx na kapici / Nastavak Torx za nasadke / Καρυδάκι με μύτη Torx / Vaso torx / Inserto Torx con bussola / Ponteiros Torx no bico / Embouts Torx sur ajutage / Trox eindstuk op dop

 T20, T25, T27, T30, T40, T45, T50, T55, T60

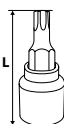

25 years
GUARANTEE



S2
steel

1/2"

CrV
steel

x9

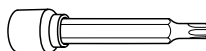

H6, H7, H8, H10, H12
T25, T30, T40, T45, T50, T60
M6, M8, M10, M12, M14



T20, T25, T27, T30, T40, T45, T50, T60

S2
steel

x49

CrV
steel



1/2"

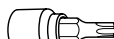

H5, H6, H7, H8, H10, H12, H14, H17, H19
T20, T25, T27, T30, T40, T45, T50, T55, T60, T70
M5, M6, M8, M10

Ref.	L[mm]	☒	EAN
08-707	55	0/12	5907558409277

 T20, T25, T27, T30, T40, T45, T50, T55, T60

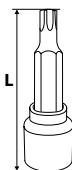

25 years
GUARANTEE



S2
steel

1/2"

CrV
steel

x9



Ref.	L[mm]	☒	EAN
08-708	100	0/12	5907558409284

Ref.	☒	EAN
08-713	0/3	5907558420180

Końcówki i nasadki torx

Torx bits and socket set / Torx-Aufsätze / Наконечники и головки торцевые Torx / Набор жезла та насадок «torx» / Torx kulcskészlet / Set canule "torx" și fixări / Биты а nástавце Torx / Súpava klúčov torx / Garnitura nastavkov z vpenjalom / Antgališ Torx ir galviš rinkinys / Torx atslėgu un taciņu komplekts / "Torx" atsikute ja padrunite komplekt / Вложки и накрайници / Set Nasadnih ključeva I biceva / Set biceva I gedora / Συλλογή από μύτες και καρυδάκια / Puntas destornilladoras y vasos TORX / Inserti Torx / Ponteiros e Bocais Torx / Embouts et douilles Torx / Torx eindstukken en doppen



E4, E5, E6, E7, E8, E10, E11, E12, E14, E16, E18, E20
T10, T15, T20, T25, T27, T30, T40, T45, T50, T55, T60
TT10, TT15, TT20, TT25, TT27, TT30, TT40, TT45, TT50, TT55



CrV
steel

S2
steel

3/8"



x34





Ref.	☒	EAN
08-711	0/12	5907558417111

Nasadki Torx

Torx sockets / Torx-Aufsätze / Головки сменные Torx / Насадки «Torx» / Torx kulcs / Tubulara cu capat torx / Nástavce Torx / Nástavce Torx / Nasadni ključ Torx / Torciniai antgaliai / Torx nomaināmas galviņas / Torx-padrūnīd / Насадки Torx / Каріце Torx / Nasadke Torx / Ανταλλακτικές μύτες Torx / Vasos torx / Bussole Torx / Bocais Torx / Douilles Torx / Torx doppen

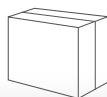
  E10, E11, E12, E14, E16, E18, E20, E22, E24



Ref.		EAN
08-649	0/15	5907558417074



Końcówki wkrętaskowe

Driver bits / Einsätze für Schraubendreher / Насадки / Наконечники викртові / Dugókulcs bitkészlet / Set biti / Šroubovákové nástavce / Skrutkovacie nástavce / Nastavki za izvijače / Atsuktuvo antgaliai / Skrūvgrieža uzgaļi / Kruvikeerajaotsakud / Накрайници за отвёртка / Nastavci za odvijajč / Nastavci za odvijajč / Καταβιδόμυτες / Puntas destornilladoras / Inserti lunghi e corti / Ponteiros Chave de fenda / Embouts de tournevis / Schroevendraaiereindstukken



 $\pm 10 \text{ mm}$
L 30 mm

 $\pm 10 \text{ mm}$
L 75 mm

-  30 mm: T20, T25, T30, T40, T45, T50, T55
75 mm: T20, T25, T30, T40, T45, T50, T55
-  30 mm: H4, H5, H6, H7, H8, H10, H12
75 mm: H4, H5, H6, H7, H8, H10, H12
-  30 mm: M5, 6, 8, 10, 12
75 mm: M5, 6, 8, 10, 12

 $3/8" \triangleright 10 \text{ mm}$
 $1/2" \triangleright 10 \text{ mm}$

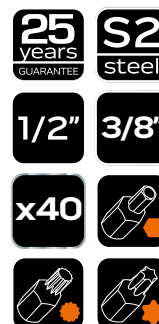

Ref.		EAN
06-107	0/10	5907558414424

H7, H10, H11, H13, H14, H17, H19, H22, H24
TS10, TS15, TS20, TS25, TS27, TS30, TS40, TS45, TS50
T30, T40, T45, T50, T55, T60, T70, T80
M9, M10, M12, M14, M16
R7, R8, R9, R10
H5

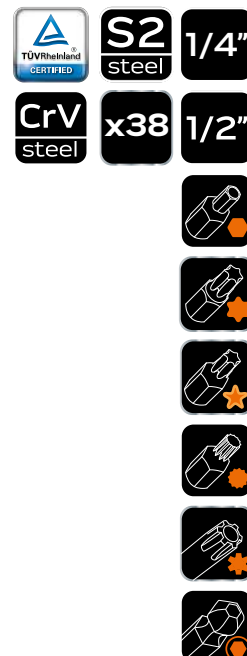

Ref.		EAN
08-710	0/3	5907558417104

Końcówki wkrętakowe

Driver bits / Einsätze für Schraubendreher / Насадки / Наконечники викртові / Dugókulcs bitkészlet / Set biti / Šraubovákové nástavce / Skrutkovacie nástavce / Nastavki za izvijače / Atsuktuvo antgaliai / Skrtvgrieža uzgaļi / Krivikeerajaotsakud / Накрайници за отвёртка / Nastavci za odvijač / Nastavci za odvijač / Καταβιδόμετες / Puntas destornilladoras / Inserti lunghi e corti / Ponteiros Chave de fenda / Embouts de tournevis / Schroevendraaiereindstukken



Ref.	Info	L[mm]	☒	EAN
10-970	H5	30	50/200	5907558452884
10-972	H6	30	50/200	5907558452891
10-978	H12	30	50/200	5907558452907
10-980	H5	75	30/120	5907558452914
10-982	H6	75	30/120	5907558452921
10-988	H12	75	30/120	5907558452938



Ref.	Info	L[mm]	☒	EAN
10-920	T30	30	50/200	5907558452785
10-922	T40	30	50/200	5907558452792
10-924	T45	30	50/200	5907558452808
10-926	T50	30	50/200	5907558452815
10-928	T55	30	50/200	5907558452822
10-940	T30	75	30/120	5907558452839
10-942	T40	75	30/120	5907558452846
10-944	T45	75	30/120	5907558452853
10-946	T50	75	30/120	5907558452860
10-948	T55	75	30/120	5907558452877
10-960	T100	75	20/40	5907558452945

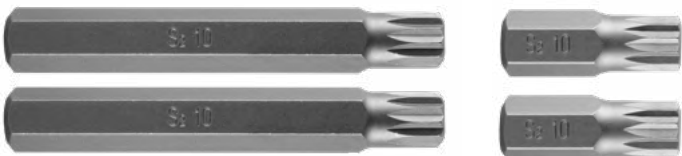

Ref.	Info	L[mm]	☒	EAN
10-900	M8	30	50/200	5907558452723
10-902	M10	30	50/200	5907558452730
10-904	M12	30	50/200	5907558452747
10-906	M8	75	30/120	5907558452754
10-908	M10	75	30/120	5907558452761
10-910	M12	75	30/120	5907558452778



Klucze sześciokątne

Hex key set / Sechskantschlüssel / Ключи шестигранные / Ключ шестигранный / Imbuskulcs készlet / Set chei cu șase laturi / Šestihránný klíč / Šiprava imbus ključev (dlhé) / Garnitura inbus ključev / Šešakampij raktų komplektas / Seškanšu atslēgu komplekts / Kuuskant-mutrivõtmete komplekt / Лумбусу компл. / Ključ imbus set / Ключ имбус set / Συλλογή εξαγωνικών κλειδιών / Llaves Allen / Chiavi esagonali / Chaves hexagonais / Clefs à 6 pans / Zeskantsleutels

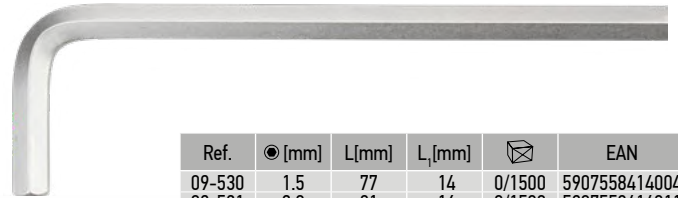
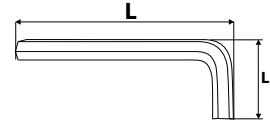

Ref.	☉[mm]	L[mm]	L ₁ [mm]	☒	EAN
09-530	1.5	77	14	0/1500	5907558414004
09-531	2.0	81	16	0/1500	5907558414011
09-532	2.5	87	18	0/1500	5907558414028
09-533	3.0	94	20	0/1500	5907558414035
09-534	4.0	103	24	0/1000	5907558414042
09-535	4.5	108	26	0/800	5907558414059
09-536	5.0	115	28	0/500	5907558414066
09-537	5.5	122	30	0/500	5907558414073
09-538	6.0	129	32	0/500	5907558414080
09-539	7.0	136	34	0/300	5907558414097
09-540	8.0	147	36	0/200	5907558414103
09-541	9.0	159	38	0/200	5907558414110
09-542	10.0	170	40	0/150	5907558414127
09-543	12.0	190	45	0/80	5907558414134
09-544	13.0	205	48	0/80	5907558414141
09-545	14.0	216	54	0/60	5907558414158
09-546	17.0	245	63	0/40	5907558414165



☉[mm]	L[mm]	L ₁ [mm]
2.0	85	18
2.5	90	20
3.0	97	23
4.0	106	28
5.0	118	30
6.0	138	36
8.0	159	40
10.0	180	46

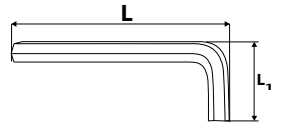

Ref.	☒	EAN
09-523	10/40	5907558414288



☉[mm]	L[mm]	L ₁ [mm]
1.5	92	15
2.0	100	18
2.5	114	20
3.0	127	22
4.0	143	28
5.0	164	31
6.0	185	37
8.0	205	43
10.0	235	47

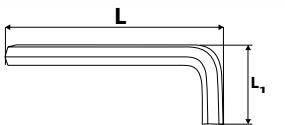

Ref.	☒	EAN
09-525	6/24	5907558414301

Klucze sześciokątne

Hex key set / Sechskantschlüssel / Ключи шестигранные / Ключ шестигранный / Imbusz kulcs készlet / Set chei cu șase laturi / Šestihránný klič / Súprava imbus klúčov / Garnitura imbus ključev / Šešakampij raktų komplektas / Seškanšu atslēgu komplekts / Kuuskant-mutrivõtmete komplekt / Лумбуси компл. / Kļuč imbus set / Kļuc imbus set / Συλλογή εξαγωνικών κλειδιών / Llaves Allen / Chiavi esagonali / Chaves hexagonais / Clefs à 6 pans / Zeskantsleutels

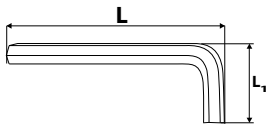

● [mm]	L [mm]	L ₁ [mm]
1.5	91	16
2.0	103	19
2.5	115	20
3.0	130	23
4.0	145	29
5.0	166	35
6.0	188	38
8.0	208	43
10.0	230	50



Ref.	📦	EAN
09-512	6/48	5907558403428



● [mm]	L [mm]	L ₁ [mm]
1.5	63	15
2.0	75	17
2.5	87	20
3.0	90	23
4.0	100	27
5.0	116	32
6.0	137	37



Ref.	📦	EAN
09-517	10/100	5907558410273

● 1.5 - 2 - 2.5 - 3 - 4 - 5 - 6 - 8 mm



Ref.	📦	EAN
09-571	6/24	5907558450460

Klucze Torx

Torx key wrench set / Torx-Schlüssel / Ключи Torx / Ключи "Torx" / Torx kulcskészlet / Set chei de tip "torx" / Kliče Torx / Súprava Torx klúčov / Garnitura ključev torx / Raktai TORX / Torx atslēgu komplekts / "Torx" mutrivõtmete komplekt / Лумбуси компл. / Kļuc imbus / Кλειδιά Torx / Llaves torx / Set chiavi Torx / Chaves torx / Clefs Torx / Torxsleutels

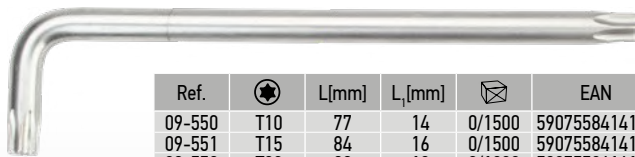
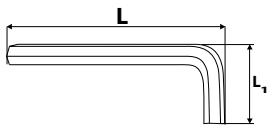

Ref.	●	L [mm]	L ₁ [mm]	📦	EAN
09-550	T10	77	14	0/1500	5907558414172
09-551	T15	84	16	0/1500	5907558414189
09-552	T20	92	18	0/1000	5907558414196
09-553	T25	101	20	0/1000	5907558414202
09-554	T27	111	24	0/500	5907558414219
09-555	T30	122	28	0/500	5907558414226
09-556	T40	136	32	0/400	5907558414233
09-557	T45	152	36	0/300	5907558414240
09-558	T50	176	40	0/200	5907558414257
09-559	T55	183	44	0/100	5907558414264



●	L [mm]	L ₁ [mm]
T10	89	20
T15	105	22
T20	115	23
T25	130	25
T27	146	30
T30	167	35
T40	184	38
T45	204	45
T50	226	50

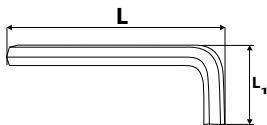

Ref.	📦	EAN
09-518	6/48	5907558420661



●	L [mm]	L ₁ [mm]
TT10	88	20
TT15	93	22
TT20	98	23
TT25	105	24
TT30	119	30
TT40	130	32
TT45	144	37
TT50	160	40



Ref.	📦	EAN
09-524	10/40	5907558414295

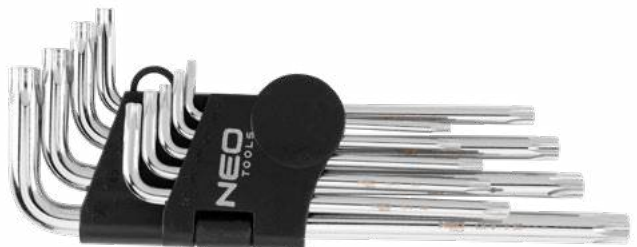

●	L [mm]	L ₁ [mm]
T10	89	20
T15	105	22
T20	115	23
T25	130	25
T27	146	30
T30	167	35
T40	184	38
T45	204	45
T50	226	50



Ref.	📦	EAN
09-526	6/24	5907558414318

Klucze Torx

Torx key wrench set / Torx-Schlüssel / Ключи Torx / Ключи "Torx" / Torx kulcskészlet / Set chei de tip "torx" / Klíče Torx / Súprava Torx klúčov / Garnitura ključev torx / Raktai TORX / Torx atslėgu komplekts / "Torx" mutrivõtmete komplekt / Лумбуси компл. / Ključ imbus / Κλειδιά Torx / Llaves torx / Set chiavi Torx / Chaves torx / Clefs Torx / Torxsleutels

★ T9; T10; T15; T20; T25; T27; T30; T40

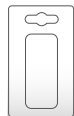

Ref.	📦	EAN
09-573	6/24	5907558450477



Klucze trzpieniowe z przetyczką

Studwrenches with cotter pin / Schraubenschlüssel mit Splint / Шпильные ключи со шплинтом / Γαϊκωί κλειδιά зі шплинтом / Csavarozókulcsok csapszeggel / Chei cu știfturi cu știfturi / Sroubové klíče se závlačkou / Klíče so závlačkou / Ključji za vijake z zatičem / Šakiniai veržliarakčiai su dantyuoju kaiščiu / Atslėgas ar tarpkrūvėm / Spikerīga mutrivõtmed / Ключове за шпилки със зъбен колелце / Ključevni u obliku slova L sa klinom / Кључеви са Л кључем са игол / Συμβαστικά κλειδιά με στέλεχος / Llaves de espàrrago con chaveta / Chiavi per viti prigioniere con corgiglia / Chaves de fenda com contrapino / Clés à goujon avec goupille fendue / Moersleutels met splitpen

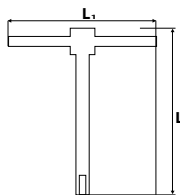
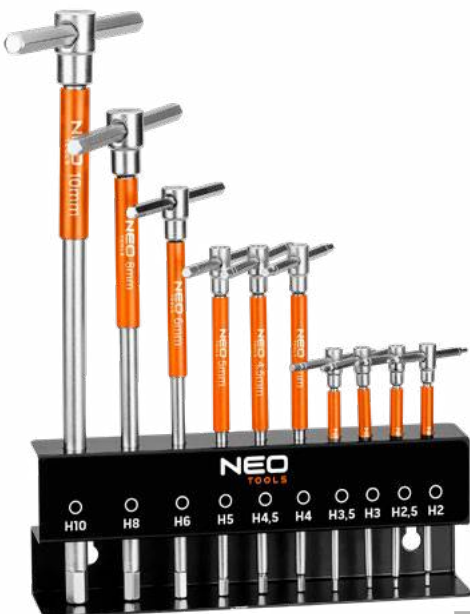

⌀ [mm]	L [mm]	L ₁ [mm]
H2	125	65
H2,5	125	65
H3	125	65
H3,5	125	65
H4	177	90
H4,5	177	90
H5	177	90
H6	209	116
H8	248	120
H10	300	143

Ref.	📦	EAN
09-509		5907558477238

Kluczyk uniwersalny do szafek

Universal control cabinet key / Universalschlüssel für Schränke / Ключ универсальный для шкафов / Ключ универсальный до шаф / Chiave universale per armadietti / Cheie univesala pentru dulapuri / Univerzální klíč na rozvodné skříně / Univerzálny klúčik na skrinky / Univerzalni ključ za električne omarice / Elektros spintelių raktas, universalus / Univeršala atslėga skapjėm / Univeršaalne karivõti / Универсален ключ за шкафчета / Univerzalni ključ za ormare / Univerzalni ključ / Κλειδιά γενικής χρήσης για ντουλάπια εργασιών / Llave universal para armarios / Chiave universale per armadietti / Chave universal para armários / Clé pour armoires universelle

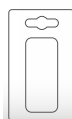

Ref.	📦	EAN
02-001	50/200	5907558404319

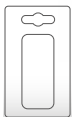

Ref.	📦	EAN
01-402	24/192	5907558449631



Ref.	📦	EAN
02-002	50/200	5907558499780



Pokreřtlo

Wheel / Drehknopf / Вороток / Маховик / Hajtákar / Clupă / Otočný knoflík / Ovládacie koliesko / Raglja / Rankena / Grietzuvite / Nupp / Върток / Kотаціці / Ručica / Πόμολο / Mango / Impugnatura a L / Batão / Tourne-à-gauche / Draaiknop



Ref.	📦	EAN
08-257	10/100	5907558466362

Klucz dynamometryczny

Torque wrench / Drehmomentschlüssel / Ключ динамометрический / Ключ динамометричний / Nyomatékkulcs / Cheie dinamică / Dynamometrický klíč / Dynamometrický ključ / Dinamometrični ključ / Dinamometrinis raktas / Dinamometriska atslēga / Dīnamoetriline vōti / Динамометричен ключ / Dinamometrički ključ / Obrtni ključ / Δυναμομετρικό κλειδί / Llave dinàmètrica / Chiave dinamometrica / Chave dinamométrica / Clef dynamométrique / Dynamometrische sleutel

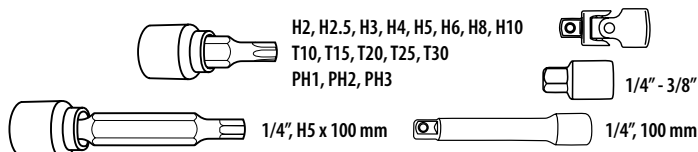

Ref.	Info	⊠	EAN
08-821	0/12		5907558458954



Ref.	Info	⊠	EAN
08-835	40-220Nm	0/6	5907558458930
08-837	60-330Nm	0/6	5907558458947



Ref.	Info	⊠	EAN
08-823	3/8", 10 - 60 Nm	1/10	5907558444544
08-824	3/8", 20 - 100 Nm	1/10	5907558444551
08-825	1/2", 40 - 200 Nm	1/10	5907558444568
08-826	1/2", 60 - 350 Nm	1/4	5907558444599



Ref.	Info	⊠	EAN
08-827	1/2", 20 - 210 Nm	1/10	5907558444575
08-828	1/2", 60 - 350 Nm	1/10	5907558444582



Ref.	Info	⊠	EAN
08-822	5-25Nm	1/20	5907558471168



Ref.	Info	⊠	EAN
08-838	160-800Nm	1/2	5907558469745
08-839	20-1000Nm	1/2	5907558469752



Ref.	Info	⊠	EAN
08-843	5-350Nm	1/4	5907558471168



Ref.	Info	⊠	EAN
08-845	5-330Nm	1/2	5907558463538

Kątomierz do dokręcania śrub

Torque angle gauge / Winkelmesser zum schraubenanziehen / Угломер для затяжки болтов / Кутомір для догвинчування гвинтів / Szögmérő csavar meghúzásához / Raportor la strângerea șuruburilor / Úhloměr k utahování šroubů / Uhlomer krútiaceho momentu / Kotomer za privijanje vijakov / Varžica užpraidimo kamro matuoklis / Leņķmērs skrūvju pievilkšanai / Nurgatõõdik poltide pingutamiseks / Ёломер за дынамометрычнe ключ / Kutomer za zatezanje vijaka / Uglomer za zavrtanje šrafova / Γωνιόμετρο σύσφιξης βιδών / Escuadra para atornillar tornillos / Goniometro per avvitare le viti / Transferidor para aparafusar / Clé de serrage angulaire



Ref.	📦	EAN
08-830	1/12	5907558416770

1/2"

360°

Klucz płasko-oczkowy

Combination spanner / Maul-Ringschlüssel / Ключ комбинированный / Ключ комбінований, ріжково-накидний / Csillag-villáskulcs / Cheie combinată / Ključ očko-plochy / Ključ OP / Ključ viličasto-obročni / Raktas plokščias - kilpinis / Kombinētā atslēga / Universaalne mutrivõti / Ключ звездогаечен / Ključ kombinirani / Ključ kombinovani / Γερανοπολύγωνο / Llave combinada / Chiave combinata / Chave plana-de luneta / Clef à fourche-polygonale / Moersleutel



Ref.	● [mm]	L [mm]	📦	EAN	Ref.	● [mm]	L [mm]	📦	EAN
09-706	6	100	0/200	5907558410914	09-722	22	260	5/50	5907558411072
09-707	7	110	5/200	5907558410921	09-723	23	260	5/30	5907558411089
09-708	8	120	5/200	5907558410938	09-724	24	280	5/50	5907558411096
09-709	9	130	5/200	5907558410945	09-725	25	295	5/40	5907558411102
09-710	10	140	5/200	5907558410952	09-727	27	310	5/50	5907558411126
09-711	11	150	5/200	5907558410969	09-728	28	310	5/40	5907558411133
09-712	12	160	5/200	5907558410976	09-729	29	340	4/40	5907558411140
09-713	13	170	5/200	5907558410983	09-730	30	340	4/30	5907558411157
09-714	14	180	5/100	5907558410990	09-732	32	360	4/40	5907558411164
09-715	15	190	5/100	5907558411003	09-734	34	380	4/20	5907558411171
09-716	16	200	5/100	5907558411010	09-736	36	410	5/10	5907558412611
09-717	17	210	5/100	5907558411027	09-738	38	430	5/20	5907558412628
09-718	18	220	5/100	5907558411034	09-741	41	460	2/10	5907558412635
09-719	19	230	5/100	5907558411041	09-746	46	500	5/10	5907558412642
09-720	20	240	5/100	5907558411058	09-747	50	540	5/10	5907558412659
09-721	21	250	5/100	5907558411065	09-749	60	600	0/2	5907558412673



Ref.	● [mm]	L [mm]	📦	EAN
09-406	6	100	25/400	5907558422375
09-407	7	110	25/400	5907558422382
09-408	8	120	25/400	5907558422399
09-409	9	130	25/400	5907558422405
09-410	10	140	25/400	5907558422412
09-411	11	150	25/300	5907558422429
09-412	12	160	25/300	5907558422436
09-413	13	170	25/300	5907558422443
09-414	14	180	25/200	5907558422450
09-415	15	190	25/200	5907558422467
09-416	16	200	25/150	5907558422474
09-417	17	210	25/150	5907558422481
09-418	18	220	10/120	5907558422498
09-419	19	230	10/120	5907558422504
09-421	21	250	10/100	5907558422528
09-422	22	260	10/100	5907558422535
09-424	24	280	10/80	5907558422559
09-427	27	310	10/40	5907558422580
09-429	29	340	10/40	5907558422603
09-430	30	340	10/40	5907558422610
09-432	32	360	10/40	5907558422627



Ref.	● [mm]	L [mm]	📦	EAN
09-650	6	100	1/25	5907558467482
09-651	7	110	1/25	5907558467499
09-652	8	120	1/25	5907558467505
09-653	9	130	1/25	5907558467512
09-654	10	140	1/25	5907558467529
09-655	11	150	1/25	5907558467536
09-656	12	160	1/25	5907558467543
09-657	13	170	1/25	5907558467550
09-658	14	180	1/25	5907558467567
09-659	15	190	1/25	5907558467574
09-660	16	200	1/25	5907558467581
09-661	17	210	1/25	5907558467598
09-662	18	220	1/10	5907558467604
09-663	19	230	1/10	5907558467611
09-665	21	250	1/10	5907558467628
09-666	22	260	1/10	5907558467635
09-668	24	280	1/10	5907558467642
09-671	27	310	1/10	5907558467659
09-672	29	340	1/10	5907558467666
09-674	30	340	1/10	5907558467673
09-675	32	360	1/10	5907558467680

Klucz płasko-oczkowy

Combination spanner / Maul-Ringschlüssel / Ключ комбинированный / Ключ комбінований, ріжково-накидний / Csillag-villáskulcs / Cheie combinată / Кліч ошко-пlochý / Кліч OP / Кљуџ виљчasto-оброџни / Raktas plokščias - kilpinis / Kombinētā atslēga / Universaalne mutrivõti / Ключ звездозагачен / Кљуџ комбинирани / Кљуџ комбинирани / Γερμανοπολύγωνο / Llave combinada / Chiave combinata / Chave plana-de luneta / Clef à fourche-polygonale / Moersleutel



Ref.	● [mm]	L [mm]	☒	EAN
09-760	8	90	10/200	5907558410198
09-761	9	93	5/200	5907558410204
09-762	10	96	5/200	5907558410211
09-763	11	98	10/200	5907558410228
09-764	12	102	10/200	5907558410235
09-765	13	109	5/200	5907558410242
09-766	14	113	10/200	5907558410259
09-767	15	118	10/120	5907558410266
09-768	16	123	10/120	5907558412765
09-769	17	129	10/200	5907558412772
09-770	18	131	10/120	5907558412789
09-771	19	134	10/150	5907558412796

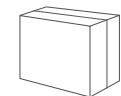

Ref.	● [mm]	N	☒	EAN
09-751	6, 8, 10, 12, 13, 14, 17, 19	x8	0/25	5907558411522
09-752	6, 7, 8, 10, 11, 12, 13, 14, 15, 17, 19, 22	x12	0/20	5907558411539
09-753	8, 9, 10, 11, 12, 13, 14, 15, 16, 17, 18, 19, 22, 24, 27, 30, 32	x17	0/6	5907558413106
09-754	6, 7, 8, 9, 10, 11, 12, 13, 14, 15, 16, 17, 18, 19, 20, 21, 22, 23, 24, 25, 26, 27, 28, 29, 30, 32	x26	0/4	5907558413113



Ref.	● [mm]	☒	EAN
09-791	8, 9, 10, 12, 13, 14, 17, 19	0/20	5907558413090

Klucz płasko-oczkowy z grzechotką

Combination spanner with ratchet / Ringschlüssel mit Ratsche / Ключ комбинированный с трещоткой / Ключ ріжково-накидний з тріскоткою / Csillag-villáskulcs racsnis / Cheie fixă -inelari cu clichet / Očkoplochý klíč ráčnový / Plochý-očkový klíč s račňou / Ploščato-obročni kļuџ z račļo / Raktas plokščias, kilpinis su terkšle / Kombinētā atslēga / Kārstīga leht-siltmusvõti / Комбинирана трескотка / Posnato-okasti kļuџ s nastavkom / Pljosnato-okasti kļuџ sa čerģtalģkom / Κλειδί γερμανοπολύγωνο με καστάνια / Llaves combinadas (de estrella y a carraca abierta) con carraca / Chiave combinata a cricchetto / Chave plana-de luneta z cetraca de furar / Clef à fourche-polygonale à cliquet / Moersleutel met ratel

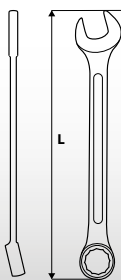

Ref.	● [mm]	L [mm]	☒	EAN
09-063	8	140	10/200	5907558424157
09-064	10	160	10/200	5907558416954
09-065	13	180	10/50	5907558416961
09-066	15	190	10/100	5907558416978
09-067	17	213	0/100	5907558416985
09-068	19	235	10/60	5907558416992
09-069	21	237	10/50	5907558424164
09-042	22	252	5/50	5907558424041
09-043	24	274	5/50	5907558424058
09-044	27	332	6/30	5907558424065
09-045	30	349	6/24	5907558424072

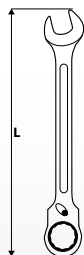

Ref.	● [mm]	L [mm]	☒	EAN
09-320	8 mm	20	10/100	5907558444919
09-321	9 mm	21	10/100	5907558444926
09-322	10 mm	22	10/100	5907558444933
09-323	11 mm	22	10/100	5907558444940
09-324	12 mm	23	10/100	5907558444957
09-325	13 mm	26	5/100	5907558444964
09-326	14 mm	27	5/100	5907558444971
09-327	15 mm	27	5/50	5907558444988
09-328	16 mm	28	5/50	5907558444995
09-329	17 mm	30	5/50	5907558445008
09-330	18 mm	31	5/50	5907558445015
09-331	19 mm	32	5/50	5907558445022
09-333	21 mm	38	5/50	5907558445046
09-334	22 mm	38	5/50	5907558445053
09-336	24 mm	42	5/25	5907558445077
09-338	26 mm	45	5/25	5907558445091
09-339	27 mm	45	5/25	5907558445107
09-340	28 mm	49	5/25	5907558445114
09-341	30 mm	49	5/20	5907558445121
09-342	32 mm	52	5/20	5907558445138



Ref.	● [mm]	L [mm]	☒	EAN
09-051	8	140	10/200	5907558403435
09-052	10	162	10/160	5907558403442
09-055	13	181	10/120	5907558403459
09-057	15	202	10/100	5907558403466
09-059	17	237	10/80	5907558403473
09-061	19	250	10/60	5907558403480
09-062	21	255	10/50	5907558424140
09-053	22	255	5/50	5907558424096
09-054	24	274	5/50	5907558424102
09-056	27	312	5/30	5907558424119
09-058	30	350	6/24	5907558424126
09-060	32	390	8/16	5907558424133

Klucz płasko-oczkowy z grzechotką

Combination spanner with ratchet / Ringschlüssel mit Ratsche / Ключ комбинированный с трещоткой / Ключ рижково-накидной з трісчаткою / Csillag-villáskulcs racsnis / Cheie fixă –inelară cu clichet / Očkolochý klíč ráčnový / Plochý-očkový klíč s račňou / Ploščato-obročni ključ z ragljo / Raktas plokščias, kilpinis su terkšle / Kombinētā atslēga / Kārstīga leht-siltmusvōti / Комбинирана тресчатка / Plosnato-okasti ključ s nastavkom / Pļosnato-okasti ključ sa čegrtaļkom / Κλειδί γερμανοπολύγωνο με καστίνα / Llaves combinadas (de estrella y a carraca abierta) con carraca / Chiave combinata a cricchetto / Chave plana-de luneta z catraca de furar / Clef à fourche-polygonale à cliquet / Moersleutel met ratel



CrV
steel

x12

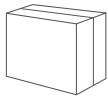

Ref.	● [mm]	📦	EAN
09-345	8, 9, 10, 11, 12, 13, 14, 15, 16, 17, 18, 19	1/8	5907558483093

CrV
steel

72



Ref.	● [mm]	📦	EAN
09-255	8	6/72	5907558495669
09-256	9	6/72	5907558495676
09-257	10	6/72	5907558495683
09-258	11	6/72	5907558495690
09-259	12	6/72	5907558495706
09-260	13	6/72	5907558495713
09-261	14	6/72	5907558495720
09-262	15	6/48	5907558495737
09-263	16	6/48	5907558495744
09-264	17	6/48	5907558495751
09-265	18	6/48	5907558495768
09-266	19	6/48	5907558495775

Klucze płaskie dwustronne

Flat double sided wrenches / Mutterschlüssel, beidseitig / Ключи с открытым зевом двухсторонние / Ключи рижкові двобічні / Villáskulcs készlet / Cheie fixa / Klíče ploché obojstranné / Klíče ploché obojstranné / Ploščati obojestranski ključji / Plokšti raktai, dvipusiai / Divpusēja plakana atslēga / Kahepoolsed lehtvõtmed / Πloski dvoustranski ključevi / Dvostrani plosnati ključevi / Dvačeljusni pļosnati ključevi / Γερανικό κλειδί διπλο / Llaves fijas dobles / Chiavi a forchetta doppia / Chaves planas de duas pontas / Clefs à fourches doubles / Vakke tweezijdige sleutels

25
years
GUARANTEE

TÜV Rheinland
CERTIFIED

CrV
steel

DIN
3110



Ref.	● [mm]	L [mm]	📦	EAN
09-806	6x7	120	10/600	5907558411195
09-808	8x9	140	10/200	5907558411201
09-810	10x11	160	10/300	5907558411218
09-812	12x13	170	10/200	5907558411225
09-814	14x15	190	10/100	5907558411232
09-816	16x17	200	10/100	5907558411249
09-817	17x19	220	10/100	5907558411454
09-818	18x19	220	5/100	5907558411256
09-819	19x22	234	10/100	5907558411461
09-820	20x22	230	5/100	5907558411263
09-821	21x23	250	5/100	5907558411270
09-824	24x27	270	5/50	5907558411287
09-825	25x28	285	5/50	5907558411294

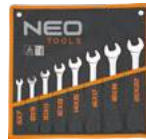

25
years
GUARANTEE

TÜV Rheinland
CERTIFIED

CrV
steel

DIN
3110

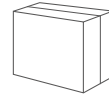

Ref.	● [mm]	N	📦	EAN
09-851	6x7, 8x9, 10x11, 12x13, 14x15, 16x17, 18x19, 20x22	8	0/20	5907558411546
09-852	6x7, 8x9, 10x11, 12x13, 14x15, 16x17, 18x19, 20x22, 21x23, 24x27, 25x28, 30x32	12	0/8	5907558413120



SUPER
THIN

x8

CS
steel

Ref.	● [mm]	📦	EAN
09-860	5,5x7, 8x9, 10x12, 11x13, 14x17, 19x21, 22x23, 24x27	0/20	5907558458916

Klucze płaskie dwustronne

Flat double sided wrenches / Mutterschlüssel, beidseitig / Ключи с открытым зевом двухсторонние / Ключи рожковой двобічної / Villáskulcs készlet / Cheie fixa / Klíče ploché oboustranné / Klíče ploché obojstranné / Ploščati obojestranski ključji / Plakšti raktaī, dvipusiai / Divpusēja plakana atslēga / Kahepoolsed lehtvõtmel / Плоски двусторонни ключове / Dvostrani plosnati ključevi / Dvočeljusni plosnati ključevi / Терпякки клеїбі дпло / Llaves fijas dobles / Chiavi a forchetta doppia / Chaves planas de duas pontas / Clefs à fourches doubles / Vlakke tweezijdige sleutels



CrMo steel x5 20 SIZES



1. 27 / 24 / 23 / 22 MM
2. 21 / 20 / 19 / 18 MM
3. 17 / 16 / 15 / 14 MM
4. 13 / 12 / 11 / 10 MM
5. 9 / 8 / 7 / 6 MM



Ref.	☒	EAN
09-270	0/0	5906692022267

Klucz oczkowy odgięty

Offset ring spanner / Ringschlüssel, gebogen / Ключ накидной изогнутый / Ключ накидний, вигнутий / Csillagkulcs enyhén hajlított / Cheie inelară-cotita / Klíč očkový vyhnutý / Očkový klíč ohnutý / Obročni uprogjnjeni ključ / Kilpinis raktas, lenktas / Izliekta uzmazna atslēga / Kõvera otsaga silmusvõti / Глук гаечен ключ отъгнат / Fleksibilni okasti ključ / Okasti ključ obrnuti / Клеїбі поліугово куртo / Llave de estrella acodada / Chiave poligonale doppia / Chave de luneta curvado / Clef polygonale contre-coudée / Gebogen ringsleutel

25 years GUARANTEE TÜV Rheinland CERTIFIED CrV steel DIN 838

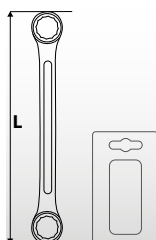

Ref.	● [mm]	L [mm]	☒	EAN
09-906	6x7	170	5/100	5907558411317
09-908	8x9	180	5/100	5907558411324
09-910	10x11	200	5/100	5907558411331
09-912	12x13	210	5/100	5907558411348
09-914	14x15	230	5/60	5907558411355
09-916	16x17	245	5/100	5907558411362
09-918	18x19	265	5/50	5907558411379
09-920	20x22	290	5/40	5907558411386
09-921	21x23	310	4/40	5907558411393
09-924	24x27	330	4/40	5907558411409
09-930	30x32	370	4/40	5907558411430



25 years GUARANTEE

TÜV Rheinland CERTIFIED

CrV steel

x12

DIN 838

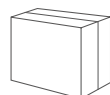

Ref.	● [mm]	☒	EAN
09-952	6x7, 8x9, 10x11, 12x13, 14x15, 16x17, 18x19, 20x22, 21x23, 24x27, 25x28, 30x32	0/6	5907558413137

Klucz oczkowy dwustronny z grzechotką, długi

Ring spanner / Ringschlüssel / Ключ накидной / Ключ накидний / Csillagkulcs / Cheie inelară / Očkový klíč / Očkový klíč / Obročni ključ / Kilpinis raktas / Uzmaucama atslēga / Silmusvõti / Глук гаечен ключ / Okasti ključ / Okasti ključ / Πολύγωνο κλειδί / Llave de estrella / Clef polygonale / Ringsleutel

25 years GUARANTEE TÜV Rheinland CERTIFIED CrV steel 72



Ref.	● [mm]	L [mm]	☒	EAN
09-360	8 mm	235	10/100	5907558445145
09-361	10 mm	289	10/100	5907558445152
09-362	12 mm	325	10/100	5907558445169
09-363	13 mm	360	5/50	5907558445176
09-364	14 mm	363	5/50	5907558445183
09-365	16 mm	390	5/50	5907558445190
09-366	17 mm	403	5/50	5907558445206
09-367	19 mm	425	5/50	5907558445213
09-368	22 mm	450	5/25	5907558445220



CrV steel x6



Ref.	● [mm]	☒	EAN
09-370	8, 10, 13, 16, 17, 19	0/8	5907558483109

25 years GUARANTEE TÜV Rheinland CERTIFIED CrV steel ADJUSTABLE SIZE



Ref.	● [mm]	☒	EAN
03-030	5 - 16	5/40	5907558445268
03-031	5 - 27	5/20	5907558445275

Klucze oczkowe wygięte

Offset ring spanner / Ringschlüssel, gebogen / Ключ накидной изогнутый / Ключ накидний, вигнутий / Csillagkulcs készlet / Cheie inelară semiluna / Očkový klíč zahnutý / Očkový klíč vyhnutý / Obročni ukrivljeni ključ / Kilpinis raktas, lenktas / Izliekta uzmazna atslēga / Poolkuu-silmusvõti / Глук гаечен ключ отъгнат / Okasti savinut ključ / Okasti izvijeni ključ / Клеїбі поліугово куртo / Llave de estrella de media luna / Chiavi doppie poligonale a mezza luna / Chaves de luneta curvadas / Clefs polygonales coudées / Uitgebogen ringsleutels



25 years GUARANTEE

TÜV Rheinland CERTIFIED

CrV steel

x5

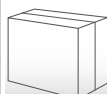

Ref.	● [mm]	☒	EAN
09-176	9x12, 13x15, 14x17, 16x18, 19x22	0/10	5907558404876

Klucz oczkowy półotwarty

Flare nut wrench / Ringschlüssel halb offen / Ключ разрезной двусторонний / Ключ торцевой наріжний двосторонній / Féksókulcs / Cheie piuliță în formă de con / Očkový kľúč polootevřený / Kľúč otvorený očkový / Obročni kľuč, odprti / Kļipinis raktas / Bremžu trubiņu atslēga / Vargamutri vōti / Ключ гаечен / Kľuč ekscentrični / Kľuc / Πολύγωνο κλειδί ημιάνοιχτο / Llave de estrella, abierta / Chiave doppia ad anello aperto / Chave de luneta semi aberta / Clef polygonale demi ouverte / Halfopen ringsleutel

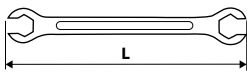

Ref.	● [mm]	L [mm]	☒	EAN
09-141	8x9	130	25/100	5907558404746
09-143	9x11	150	10/200	5907558404753
09-145	10x12	150	10/200	5907558404760
09-147	12x13	170	25/200	5907558404777
09-149	13x14	170	25/100	5907558404784
09-151	15x17	195	25/100	5907558404791

Klucze oczkowe Torx

Offset ring spanner set / Ringschlüssel / Ключи накидные колеччатые / Ключи накидні / Csillagkulcs készlet torx / Set chei inelare de deviație / Kľiče očkové / Súprava očkových kľúčov / Obročni kľuč / Kļipiniai raktai / Kombināto izliekta atslēgu komplekts / Mutrivōtmete komplekt / Ключ Лула компл. / Kľuc okasti / Πολύγωνα κλειδιά / Llaves de estrella / Chiavi combinate Torx / Chaves de luneta / Clefs polygonales / Ringsleutels

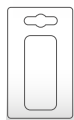

Ref.	★ [mm]	☒	EAN
09-980	T6xT8, T10xT12, T14xT18, T20xT24	20/60	5907558412239

Klucz trzpieniowy nasadowy

T-socket wrench / Vierkant-Aufsteckschlüssel / Ключ торцевой T-образный / Ключ шестигранний торцевий накідний / T-kulcs / Cheie fixare forma T / Nástrčkový kľúč typu T / T kľuč / T kľuč, nasadni / T formas raktas / T-veida gala atslēga / T-padrūni mutrivōti / T-образен ключ / T Kľuč / T kľuc / Καταβιδάκι καρυδάκι τύπου T / Llave de vaso con mango en T / Chiave a T / Chave tubular / Clef mâle à douilles articulée / Imbusdopsleutel

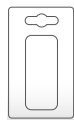

Ref.	● [mm]	L [mm]	☒	EAN
09-302	13	300	25/50	5907558414363

Wkrętak płaski

Screwdriver slotted / Flachsraubendreher / Овертка плоская / Відкрутка плоска / Csavarhúzó lapos / şurubelnijā platā / Šroubovák plochý / Skrutkovač plochý / Ploščati izvijač / Ploščštas atsuktuvus / Skrivgrzeiz plakans / Lamepa-kruvikeeraja / Овертка / Odvijač / Odvijac / Καταβιδάκι ευκαλής / Destornillador plano / Giravite piatto / Chave de fenda plana / Tournevis à fourche / Vlakke schroevendraaier

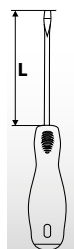

Ref.	⊖ [mm]	L [mm]	☒	EAN
04-011	3,0	75	12/240	5907558401745
04-012	4,0	100	12/240	5907558401752
04-013	5,5	100	12/120	5907558401769
04-014	5,5	200	12/144	5907558401776
04-001	6,5	38	12/288	5907558411638
04-002	6,5	125	12/144	5907558411645
04-015	6,5	150	12/144	5907558401783
04-016	8,0	200	12/120	5907558401790
04-004	10,0	200	6/96	5907558411669

Klucz nastawny do nakrętek

Adjustable spanner for nuts / Verstellbarer Schraubenschlüssel / Регулируемый гаечный ключ / Розвідний заїжковий ключ / Állítható anyakulcs / Cheie reglabilă pentru piulițe / Nastavitelny kľúč na matice / Nastaviteľný kľúč na matice / Nastavljiv kľuč za matice / Reguliuojamas veržliu veržliaraktis / Regulējama uzgriežņu atslēga / Reguleeritav mutrivōtja / Регулируем гаечен ключ / LLave ajustable para tuercas / Chiave per dadi regolabile / Chave de porca ajustável / Moersleutel



Ref.	Info	☒	EAN
03-034	19", 250 mm	1/2	5906692019373

Klucz fajkowy

L-type wrench / Pfeifenschlüssel / Рожковий ключ / Ключ торцевий кутювий / Pipakulcs / Cheie tubulară cotită / Zahnutý kľúč / Fajkový kľúč / Urogrijen kľuč / Pypkinis raktas / radziatslēga / Padrunvōti / Ключ луна / imbus kľuč / Kosoceljusni zavrtjnani kľuč / Γερμανικό κλειδί / Llave de pipa / Chiave a pipa / Chave de cabo curvo / Clef à pipe / Pijpsleutel

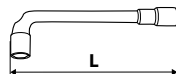

Ref.	● [mm]	L [mm]	☒	EAN
09-203	8	110	10/200	5907558405002
09-205	10	130	10/120	5907558405019
09-208	13	150	10/100	5907558405033
09-212	17	180	10/60	5907558405064
09-214	19	200	10/40	5907558405071

Wkrętak krzyżowy PZ

Screwdriver Pozidriv / Kreuzschraubendreher / Отвертка крестовая / Відкрітка хрестовидна / Csavarhúzó pozidriv / şurubelnijâ tip „Pozidriv” / Šroubovák křížový / Skrutkovač PZ / Křížni izvijač / Kryžminis atsuktavas Phillips / Skrūvgriezis krusta PZ / Ristpeakruvikeeraja Pozidriv / Отвертка / Одвијач / Одвијач / Καταβίβι τίνου pozidriv / Destornillador phillips / Giravite Pozzi / Chave de fenda de cruzeta / Tournevis en croix / Kriusschroevendraaier

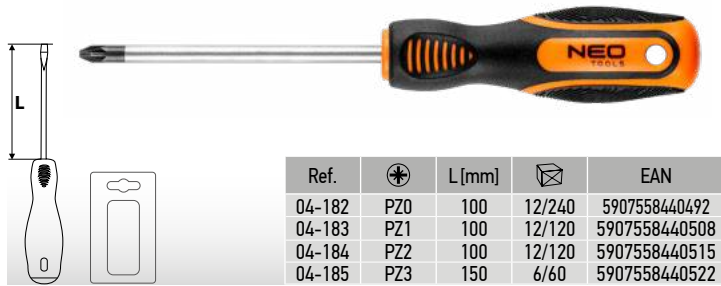

Wkrętak Torx

Torx screwdriver / Schraubendreher Torx / Отвертка Torx / Вукрџтка «Торх» / Csavarhúzó torx / Surubelnijâ varf Torx / Šroubovák Torx / Skrutkovač Torx / Izvijač Torx / Atsuktavas, torcinis / Torx skrūvgriezis / Torx-kruvikeeraja / Отвертка Torx / Одвијач Torx / Одвијач Torx / Καταβίβι Torx / Destornillador con punta torx / Giravite Torx / Chave de fenda Torx / Tournevis Torx / Torx schroevendraaier

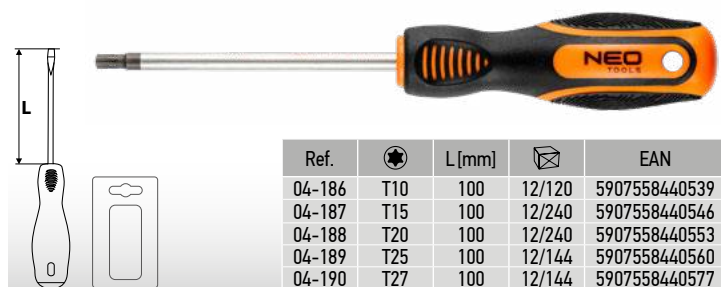

Wkrętak krzyżowy PH

Screwdriver Phillips / Kreuzschraubendreher / Отвертка крестовая / Відкрітка хрестовидна / Csavarhúzó phillips / şurubelnijâ tip „Phillips” / Šroubovák křížový / Skrutkovač PH / Křížni izvijač / Kryžminis atsuktavas Phillips / Skrūvgriezis krusta PH / Ristpeakruvikeeraja / Отвертка / Одвијач / Одвијач / Καταβίβι σταυρωτό τίνου phillips / Destornillador phillips / Giravite Phillips / Chave de fenda de cruzeta / Tournevis en croix / Kriusschroevendraaier

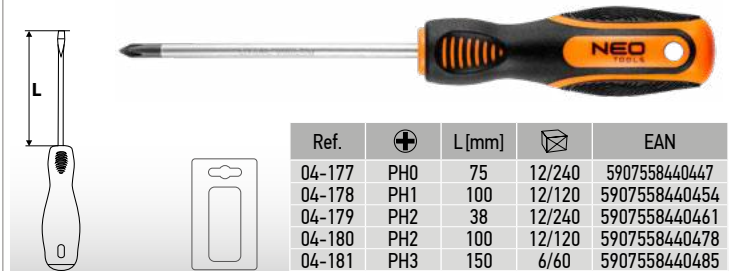
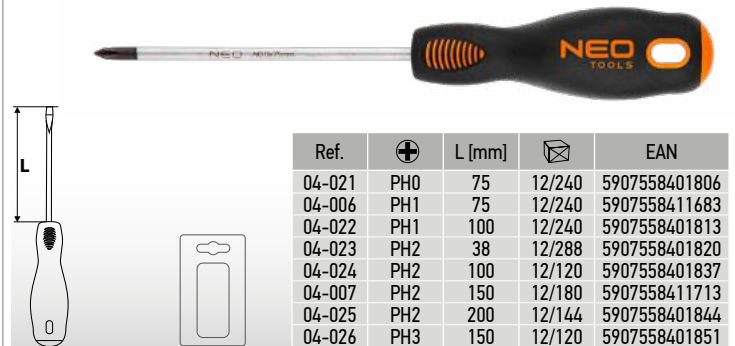

Wkrętak płaski do pobijania

Slotted screwdriver go through / Schraubendreher, flach / Отвертка шлицевая ударная / Вукрџтка плоска, ударна / Csavarhúzó üthető lapos / Surubelnijâ impact varf drept / Šroubovák plochý úderový / Sekací plochý skrutkovač / Ploščati izvijač za zabijanje / Smūginis, plokščias atsuktavas / Plakanais skrūvgriezis / Lame löökkruvikeeraja / Отвертка плоска ударна / Plosnati odvijac za nabijanje / Plijsonati odvijac za zabijanje / Καταβίβι κρούσης ενίπεδο / Destornillador plano de golpe / Giravite passante piatto / Chave de fenda plano p. malhar / Tournevis à fourche à frapper / Vlakke slagschroevendraaier



Wkrętak krzyżowy do pobijania

Screwdriver go through phillips / Kreuzschraubendreher zum Klopfen / Отвертка крестовая усиленная ударная / Відкрітка хрестовидна ударна / Csavarhúzó üthető phillips / şurubelnijâ cruciulijâ p/u spragere / Šroubovák křížový úderový / Skrutkovač úderový Phillips / Ploščati izvijač, udarni / Kryžminis, smūginis atsuktavas / Skrūvgriezis krusta PH sitiena / Ristpeakruvikeeraja / Отвертка / Одвијач / Одвијач / Σταυρωτό καταβίβι τίνου phillips / Destornillador de golpe phillips / Giravite passante Phillips / Chave de fenda de cruzeta p. malhar / Tournevis en croix à frapper / Slagkriusschroevendraaier



Wkręćaki

Screwdriver set / Schraubendreher / Отвертки / Відкрутки, набір / Csavarhúzókészlet / Set şurubelnițe / Šroubováky / Súprava skrútkovačov / Garnitura izvijačev / Atsuktuvai / Skrūvgriežu komplekts / Kruvikeerajate komplekt / Отвертки компл. / Одвијачи / Одвијач сет / Συλλογή από καταβίδια / Destornilladores / Set giraviti / Chaves de fenda / Tournevis / Schroevendraaiers



⊖ 6x125 mm; 5x100 mm; 3x75 mm
⊕ PH2x125 mm; PH1x100 mm; PH0x75 mm

Ref.	⊞	EAN
04-213	6/24	5907558432220



⊖ 8x150; 6.5x125; 5.5x100; 6.5x38 mm
⊕ PH2x125; PH1x100; PH0x75; H2x38 mm

Ref.	⊞	EAN
04-207	6/12	5907558422177



⊖ 5.5x75 mm, 6.5x100 mm
⊕ PH1x75 mm, PH2x100 mm

Ref.	⊞	EAN
04-204	6/36	5907558402254



⊖ 6.5x150; 6.5x125; 5.5x100; 3x75 mm
⊕ PH2x125, PH1x100; PH0x75 mm

Ref.	⊞	EAN
04-206	6/24	5907558422214

Wkręćaki do pobijania

Go through screwdrivers / Schraubendreher zum Aufheben / Отвертки ударные / Викрутки ударні / Csavarhúzókészlet üthető / Surubelnița de impact / Šroubováky úderové / Sekacie skrútkovače / Izvijači za zabijanje / Smūginiai suktuvai / Triecienskrūvgrieži / Löökkruvikeerajad / Ударни отвертки / Одвијачи за набijanje / Одвијаче за забijanje / Καταβίδια κρούσης / Destornilladores de golpe / Set giraviti passante / Chaves de fenda p. malhar / Tournevis à frapper / Slagschroevendraaiers



⊖ 5.5x100mm; 6.5x125mm; 8x150mm
⊕ PH1x75; PH2x100

Ref.	⊞	EAN
04-240	12/24	5907558412857

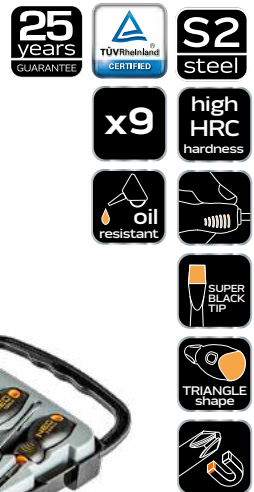

⊖ 6.5x150mm; 5.5x100mm; 3x75mm; 5.5x38mm; 6.5x38 mm
⊕ PH2x150mm; PH1x100mm; PH0x75mm; PH2x38mm

Ref.	⊞	EAN
04-208	6/12	5907558422221

Wkrętaki

Screwdriver set / Schraubendreher / Отвертки / Відкрутки, набір / Csavarhúzókészlet / Set şurubelnițe / Šroubováky / Súprava skrutkovačov / Garnitura izvijačev / Atsuktuvai / Skrūvgriežu komplekts / Kruvikeerajate komplekt / Отвертки компл. / Odvijaci / Odvijac set / Συλλογή από καταβίδια / Destornilladores / Set giraviti / Chaves de fenda / Tournevis / Schroevendraaiers

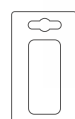

⊖ 4x250mm, 5.5x250mm
⊕ PH1x250mm, PH2x250mm

Ref.	⊠	EAN
04-214	6/24	5907558435627



⊖ 5x250 mm, 4x250 mm
⊕ PH2x250 mm, PH1x250 mm

Ref.	⊠	EAN
04-191	6/24	5907558442656



⊖ 5.5x38mm, 5.5x100mm, 6.5x150mm
⊕ PH1x100mm, PH2x38mm, PH2x150mm

Ref.	⊠	EAN
04-193	6/24	5907558442670



⊖ 3.0x75mm, 5.5x100mm, 6.5x150mm
⊕ PH1x100mm, PH2x150mm

Ref.	⊠	EAN
04-192	6/24	5907558442663



⊖ 2x50mm; 2.4x50mm; 6.5x38mm; 6.5x100mm
⊕ PH0x50mm; PH1x50mm; PH2x100mm; PH2x38mm

Ref.	⊠	EAN
04-194	6/24	5907558442687

Wkrętak odwracalny

Reversible screwdriver / Schraubendreher, umwendbar / Отвертка универсальная / Викрутка универсальна, з двобічними знімними наконечниками / Csavarhúzó / Surubelniță cu varf dublu, reversibil / Šroubovák oboustranný / Otáčací skrutkovač / Dvosmerni izvijač / Atsuktuvus su keičiamais antgaliais / Universālais skrūvgriezis / Pööratava peaga kruvikeeraja / Универсална отвертка / Povratni odvijac / Povratni odvijac / Καταβίδι γενικής χρήσης / Destornillador reversible / Giravite reversible / Chave de fenda reversível / Tournevis réversible / Omkeerbare schroevendraaier

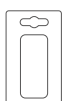

⊖ 6x38 mm
⊕ PH2x38 mm

Ref.	⊠	EAN
04-201	12/144	5907558402230



Wkrętak z grzechotką i zestawem bitów

Screwdriver with ratchet and bit set / Викрутка з хрещовиком і набором насадок / Şurubelniți cu clichet și set de biți / Csavarhúzó racsnyal és bitkészlet / Cacciavite con cricchetto e set di punte / Tournevis avec cliquet et jeu d'embouts / Schraubendreher mit Ratsche und Bitsatz / Отвертка с трещоткой и набором битов / Šroubovák s ráčnou a sadou bitů / Skrutkovač s ráčnou a sadou bitov / Odvijac s račvom i setom bitova / Atsuktuvus su reketu ir antgalių rinkiniu / Skrūvgriezis ar sprūdriem un bitu komplektu / Vijačnik z ročico in kompletom bitov / Отвертка с трещотка и комплект битов / Odvijac sa čezrtaľkom i setom bitova / Καταβίδι με χροατίνα και σετ μπιτ / Schroevendraaier met ratel en bitset / Chave de fendas com catraca e conjunto de bits / Destornillador con carraca y juego de puntas / Kruvikeeraja koos ratta ja bitikomplektiga

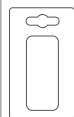

25 mm - SL 4, 5, 6 mm
PH1, PH2, PH3
T15, T20, T25
H3, H4, H5



Ref.	⊠	EAN
04-242	6/24	5906692024278

Wkrętaki i końcówki wkrętakowe

Screwdrivers and bits / Schraubendreher und Einsätze für Schraubendreher / Отвертки и насадки / Вкрутки і наконечники вкруток / Csavarhúzó és bitkészlet / Set surubelnița și capete / Šroubováky a šroubovákové nástavce / Skrutkovače a skrutkovacie nástavce / Izvijači in nastavki za izvijače / sukutvai ir antgaliai / Skrivgræzi un to uzgali / Krivikeerajad ja krivikeerajatsakud / Отвертки и наконечники за тях / Odvijači i nastavci za odvijače / Odvijači i nastavci za odvijače / Καταβίδια και καταβιδώματα / Destornilladores y puntas / Set giraviti e inserti / Chaves de fenda e ponteiros de chave de fenda / Tournevis et embouts de tournevis / Schroevendraaiers en schroevendraaiereindstukken



- ⊖ 8x150; 6.5x125; 5.5x100; 3x75; 2.5x50; 3.0x50 mm
- ⊕ PH2x125; PH1x75; PH0x50; PH0x50 mm
- ⊕ T6x50; T7x50; T8x50 mm



4; 5; 6mm; PH1; PH2; PH3; PZ1; PZ2; PZ3; T10; T15; T20; T25; H4; H5; H6

Ref.	⊠	EAN
04-209	5/10	5907558422207



- ⊖ 6.5x125; 5.5x100; 6.5x38; 2.5x50; 2.0x50 mm
- ⊕ PH2x125; PH2x100; PH1x75; PH2x38; PH0x50; PH0x50 mm
- ⊕ T5x50; T6x50; T7x50; T8x50; T9x50; T10x50 mm



3; 3; 4; 4; 5; 5; 6; 6 mm; PH0; PH0; PH1; PH1; PH2; PH2; PH3; PH3; T10; T10; T15; T15; T20; T20; T25; T25; T27; T27; T30; T30; H2; H2; H2.5; H2.5; H3; H3; H4; H4; H4; H5; H5; H6; H6

Ref.	⊠	EAN
04-211	6/12	5907558422191



- ⊖ 8x150; 6.5x100; 5.5x75; 6.5x38; 2.5x40; 3.0x40 mm
- ⊕ PH3x150; PH2x100; PH1x75; PH2x38; PH0x40; PH0x40 mm
- ⊕ T5x40; T6x40; T7x40; T8x40 mm



4; 5; 6 mm; PH1; PH2; PH3; PZ0; PZ1; PZ2; PZ3; T10; T15; T20; T25; T30; T40; H3; H4; H5; H6

Ref.	⊠	EAN
04-210	5/10	5907558422160



- ⊖ 3x75mm, 4x100 mm, 5.5x100mm, 6.5x150mm
- ⊕ PH1x100mm, PH2x150mm



4.5; 6; 7 mm; PH0, PH1, PH2, PH3; T10, T15, T20, T25, T27, T30, T40; H2, H3, H4, H5, H6

Ref.	⊠	EAN
04-197	6/12	5907558442700

Wkrętak 4w1

Reversible screwdriver / Schraubendreher, umwendbar / Отвертка универсальная / Вкрутка универсальна, з двома знімними знімними наконечниками / Csavarhúzó kétoldalas / Surubelniță cu varf dublu, reversibil / Šroubovák oboustranný / Otáčací skrutkovač / Dvsmerni izvijač / Atsuaktuva su keičiamais antgaliais / Universālais skrūvgrēzis / Pööratava peaga krivikeeraja / Универсална отвертка / Povratni odvijač / Povratni odvijač / Καταβίδι γενικής χρήσης / Destornillador reversible / Giravite reversible / Chave de fenda reversível / Tournevis réversible / Omkeerbare schroevendraaier



- ⊖ 6.5x100mm

- ⊕ PH2x100 mm, PH1x75 mm



4, 5, 6 mm; T10, T15, T20, T25, T27, T30, T40



Ref.	⊠	EAN
04-196	6/24	5907558442694



SL3, SL4
PH0, PH1

Ref.	⊠	EAN
04-241	6/24	59066

Wkrętak precyzyjny płaski

Slotted precision screwdriver / Feinschraubendreher, flach / Отвертка прецизионная шлицевая / Вкрутка прецизијна, плоска / Műszerész csavarhúzó / Surubelnjät de precizie, varf drept / Šroubovák precizní ploché / Precizny plochý skrutkovač / Precizni ploščati izvijač / Atsuktuvas plokščias, torcinis / Precizējošais plakanaisskrūvgriezis / Lame peenkrivikeeraja / Отвертка плоска прецизна / Precizni plosnati odvijač / Precizni plosnati odvijač / Κατασβίδη ακριβείας επίπεδη / Destornillador plano de precisión / Giravite di precisione piatto / Chave de fenda precisa plana / Tournevis de précision à fourche / Vlakke fijnschroevendraaier



Ref.	⌀ [mm]	L [mm]	📦	EAN
04-112	2,0	50	12/240	5907558435511
04-113	2,5	50	12/240	5907558435528
04-114	3,0	50	12/240	5907558435535

Wkrętak precyzyjny krzyżowy PH

Cross slotted precision screwdriver / Feinschraubendreher, Kreuz / Отвертка прецизионная крестовидная / Вкрутка прецизијна, крестовидна / Műszerész csavarhúzó / Surubelnjät de precizie, varf cruce / Šroubovák precizní křížový / Precizny křížový skrutkovač / Križni precizni izvijač / Atsuktuvas precizinis, kryžminis / Precizējošais krustveida skrūvgriezis / Lame ristpeakrivikeeraja / Отвертка прецизна крестата / Precizni križni odvijač / Precizni kukasti odvijač / Σταυροκατασβίδη ακριβείας / Destornillador de precisión phillips / Giravite di precisione Phillips / Chave de fenda precisa de cruzeta / Tournevis de précision en croix / Fijnkruisschroevendraaier



Ref.	⌀ [mm]	L [mm]	📦	EAN
04-115	2,0	50	12/240	5907558435511
04-116	2,5	50	12/240	5907558435528
04-117	3,0	50	12/240	5907558435535

Końcówki wkrętakowe precyzyjne z uchwytem

Precision screwdriver bits with holder / Einsätze für Schraubendreher, fein mit Aufnahm / Набор насадок прецизионных с держателем / Насадки вкруткови, прецизијни, з ручијам / Precizios csavarhúzóbetétek tartóval / Set maner si biti, precizie / Šroubovákové nástavce precizní s držadlem / Skrutkovicie nástavce precizne s upínadlom / Nastavki za precizni izvijač z vpenjalom / Atsuktuva antgaliai, preciziniai su laikikliu / Precizējošu uzgalu komplekts ar turētāju / Peenkrivikeerajatsakud koos käepidemeaga / Комплект прецизни накрајници за отвертка с држач / Precizni nastavi cza odvijač s hvataljkom / Nastavci za precizni odvijač s drškom / Σετ με κατασβίδη ακριβείας και προσαρμογέα / Puntas destornilladoras de precisión con mango / Inserti di precisione per avvitare con impugnatura / Ponteiros chave de fenda precisos com suporte / Embouts de tournevis de précision avec manche / Fijnschroevendraaierinstukken met handvat



6.3 x 25 mm

3; 4; 5; 6; 7

4; 5; 6; 6.5

T9; T10; T15; T20; T25; T30

H2.5; H3; H4; H5; H6

PZ1; PZ2; PZ3

Y1; Y2; Y3

U6; U8

2.3

R1

4 x 28 mm

1; 1.5; 2; 2.5; 3; 3.5; 4

1; 1.5; 2; 2.5; 3.5

T3; T4; T5; T6; T7; T8; T9; T10; T15; T20

H0.9; H1.3; H1.5; H2; H2.5; H3; H3.5; H4; H4.5; H5; H6

Y2

U2.6

0.8

2; 2.3

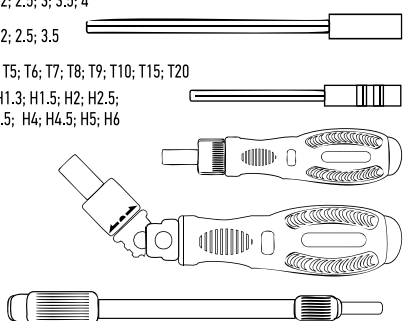

Ref.	📦	EAN
06-115	0/10	5907558431896



6.3 x 25 mm

3; 4; 5; 6; 7

4; 5; 6; 6.5

T9; T10; T15; T20; T25; T30

H2.5; H3; H4; H5; H6

PZ1; PZ2; PZ3

Y1; Y2; Y3

U6; U8

2.3

R1

4 x 28 mm

1; 1.5; 2; 2.5; 3; 3.5; 4

1; 1.5; 2; 2.5; 3.5

T3; T4; T5; T6; T7; T8; T9; T10; T15; T20

H0.9; H1.3; H1.5; H2; H2.5; H3; H3.5; H4; H4.5; H5; H6

Y2

U2.6

0.8

2; 2.3

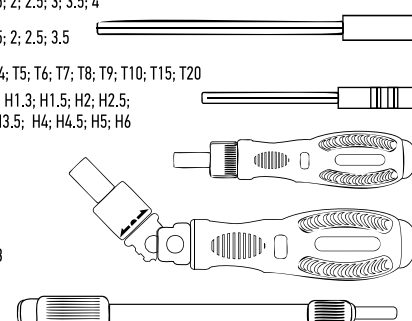

Ref.	📦	EAN
06-116	0/10	5907558431902

Końcówki wkrętakowe precyzyjne z uchwytem

Precision screwdriver bits with holder / Einsätze für Schraubendreher, fein mit Aufnahme / Набор насадок прецизионных с держателем / Насадки викрѣткови, прецизійні, з рукоят'ям / Precizios csavarhúzóbetétek tartóval / Set maner si biti, precizie / Šroubovákové nástavce precizní s držadlem / Skrutkovacie nástavce precízne s uchytením / Nastavki za precizni izvijač z vpenjalom / Atsuktuvo antgaliai, preciziniai su laikikliu / Precizėjeišu uzgaļu komplekts ar turētāju / Peenkruikeerajaotsakud koos käepidemega / Комплект прецизни накрайници за отвертка с держач / Precizni nastavi cza odvijač s hvataljkom / Nastavci za precizni odvijač s drškom / Set με καταβιδόμετες ακριβείας και προαρμογέα / Puntas destornilladoras de precisión con mango / Inserti di precisione per avvitare con impugnatura / Ponteiros chave de fenda precisos com suporte / Embouts de tournevis de précision avec manche / Fijnschroevendraaiereindstukken met handvat



CrV steel x45

- ⊖ 1/1.5/2/2.5/3/3.5
- ⊕ PH000/PH000/PH00/PH00/PH0/PH1
- ⊕ T4/T5/T6/T7/T8/T9/T10/T11/T20
- ⊕ H0.7/H0.9/H1.3/H2/H2.5/H3/H4
- ⊕ Y000
- ⊕ 0.8/0.8/1.2/1.2
- ⊕ 2.5/3/3.5/4/4.5/5/5.5 mm
- ⊕ PZ0/PZ1

Ref.	⊠	EAN
06-111-1	20/40	5907558479670

Szko powiększające

Magnifying glass / Lupe / Увеличительное стекло / Збільшувальне скло / Nagyító / Vergrößerungsglas / Lupă / Zväčšujúce sklo / Povečevalno steklo / Didinamasis stiklas / Palielinošais stikls / Suurendusklaas / Лупа / Povečalo / Лупа / Μεγεθυντικός φακός / Лупа / Lente d'ingrandimento / Lente de aumento / Loupe / Vergrotingsglas /



3xLED light DPT 2.5x 110 mm DPT 4x 20 mm DPT 25x 20 mm X3 AAA

Ref.	⊠	EAN
06-129	10/80	5907558444810

Soczewki powiększające

Magnifying lenses / Vergrößerungslinsen / Увеличительные линзы / Линзи збільшувальні / Nagyító lencsék / Lentile de mărire / Zvětšovaci čočky / Zväčšujúce šošovky / Povečevalne leče / Didinamiēji lēšiai / Palielinošās lēcas / Suurendusklaasid / Увеличительни леци / Povečale leče / Повећала сочива / Μεγεθυντικοί φακοί / Lentes de aumento / Lenti d'ingrandimento / Lentes de aumento / Lentilles grossissantes / Vergrotende lenzen



2xLED light DPT 1.0x, 1.5x, 2.0x, 2.5x, 3.5x X2 AAA

Ref.	⊠	EAN
06-130	0/40	5907558444827

Zestaw otwieraków

Opener set / Öffner-Satz / Открывалки набор / Набір інструменту для розкладання / Szétválasztó készlet / Set deschizătoare / Súprava otváračov / Sada otviracích nástrojů / Set odpiral / Atidarymo komplektas / Atvērēju komplekts / Avaja komplekt / Комплект отварачки / Set otvarača / Отварач сет / Set ανοιχτήρι / Juego de abridor / Leve di separazione / Conjunto abridor / Jeu d'ouvreurs / Opener set

ANTI STATIC x13

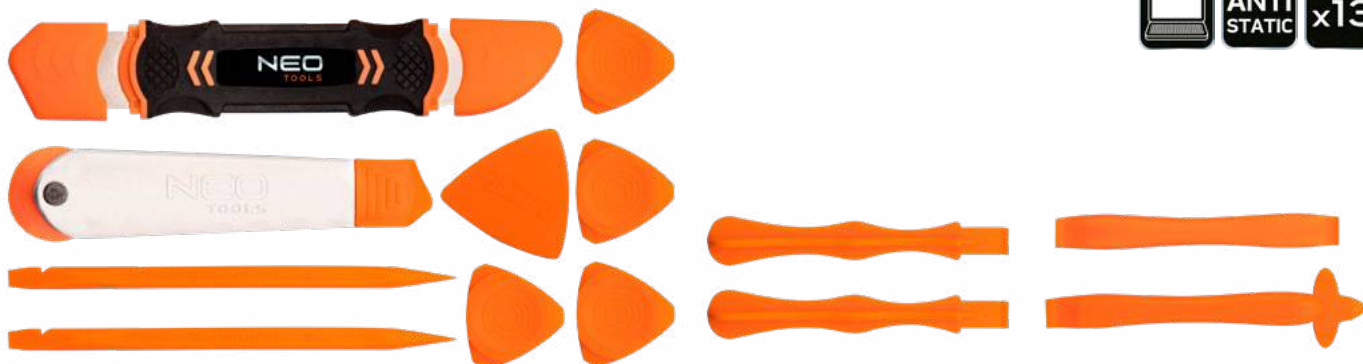

Ref.	⊠	EAN
06-127	60/120	5907558444797

Szpikulec

Point chisel / Spicknadel / Наконечник / Шило / Ár / Tijä ascuțită / Hrot / Šidlo / Igla za pretikanje / Yla / Caurumsitis / Naaskel / Шило / Šiljak / Probačač, šilo / Μύτη / Púa / Punteruolo / Ponta / Pointe / Puntbeitel

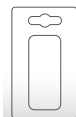

Ref.	📦	EAN
04-037	12/120	5907558435917

Haki

Hooks / Hacken / Крюки / Гаки / Horgok / Cârlige / Háky / Skoby / Kljuka / Kablrai / Āķi / Haagid / Кукы / Kuke / Kuke / Γάντζοι / Ganchos / Ganci / Anzóis / Crochets / Haken



Ref.	📦	EAN
04-231	6/72	5907558483901

Wkrętarz udarowy

Impact screwdriver / Schlag-Schraubendreher / Отвертка ударная / Винкрутка ударна / Ütvecsavarozó / Surubelnija cu percutor / Šroubovák rázový / Rázový skrutkovač / Udarni izvijač / Smūginis suktuvas / Trieciena skrūvgriezis / Löökkruvikeeraja / Ударна отвертка / Odvijač s udarom / Udarni odvijač / Καταβίβι κρούσης / Destornillador de impacto / Cacciavite a percussione / Chave de fenda de impacto / Tournevis à chocs / Slagschroevendraaier



- 5, 6, 8, 10, 12, 14 mm
- PH1, PH2, PH3



Ref.	m[kg]	📦	EAN
04-250	1,2	0/12	5907558410082

Wkrętarz akumulatorowy

Cordless Screwdriver / Akku-Schraubendreher / Отвертка аккумуляторная / Шрубоверт аккумуляторний / Akkumulátoros csavarozó / Surubelnija cu acumulator / Akumulátorový šroubovák / Akumulátorový skrutkovač / Akumulatorski vijačnik / Akumulatorinis suktuvas / Akumulatora skrūvgriezis / Akukruvikeeraja / Аккумуляторна отвертка / Akumulatorski odvijač / Akumulatorski odvijač / Εναρφοφόρμενο καταβίβι / Destornillador a batería / Avvitatore a batteria / Chave de fenda de bateria / Tournevis à batteries / Accu schroevendraaier



Ref.	📦	EAN
04-200	0/16	5907558439380



Ref.	📦	EAN
04-199	0/30	5907558483888

Wkrętak płaski 1000V

Screwdriver slotted / Flachschraubendreher / Отвертка плоская / Відкрітка плоска / Csavarhúzó / şurubeliňiä platä / Šroubovák plochý / Skrutkovač plochý / Ploščati izvijač / Ploščias atsuktuvass / Skrūvgrieziis plakans / Лампеа-kruvikeeraja / Отвертка / Odvijač / Odvijac / Καταβίβι εκροής / Destornillador plano / Giravite piatto 1000V / Chave de fenda plana / Tournevis à fourche / Vlakke schroevendraaier



Ref.	⌀ mm	L[mm]	L ₁ [mm]	⊠	EAN
04-051	2,5	150	75	12/600	5907558401998
04-052	3,0	175	100	12/240	5907558402001
04-053	4,0	205	100	12/240	5907558402018
04-054	5,5	230	125	12/144	5907558402025
04-055	6,5	270	150	12/144	5907558402032

Ref.	⌀ mm	L[mm]	L ₁ [mm]	⊠	EAN
04-130	0.4	175	75	12/120	5907558433227
04-131	0.6	195	100	12/120	5907558433234
04-132	0.8	198	100	12/120	5907558433241
04-133	1.0	230	125	12/120	5907558433258

Wkrętak krzyżowy PH 1000V

Screwdriver Phillips / Kreuzschraubendreher / Отвертка крестовая / Відкрітка хрестовида / Csavarhúzó philips / şurubeliňiä tip „Phillips” / Šroubovák křížový / Skrutkovač PH / Křížni izvijač / Kryžminis atsuktuvass Phillips / Skrūvgrieziis krusta PH / Ristpeakruvikeeraja / Отвертка / Odvijač / Odvijac / Καταβίβι σταυρωτά τύπου philips / Destornillador philips / Giravite Phillips / Chave de fenda de cruzeta / Tournevis en croix / Kriusschroevendraaier



Ref.	⊕	L[mm]	L ₁ [mm]	⊠	EAN
04-071	PH0	135	60	12/600	5907558402070
04-072	PH1	190	80	12/240	5907558402087
04-073	PH2	215	100	12/144	5907558402094

Ref.	⊕	L[mm]	L ₁ [mm]	⊠	EAN
04-137	PH0	160	60	12/120	5907558433296
04-138	PH1	185	80	12/120	5907558433302
04-139	PH2	210	100	12/120	5907558433319

Wkrętak krzyżowy PZ 1000V

Screwdriver Pozidriv / Kreuzschraubendreher / Отвертка крестовая / Відкрітка хрестовида / Csavarhúzó pozidriv / şurubeliňiä tip „Pozidriv” / Šroubovák křížový / Skrutkovač PZ / Křížni izvijač / Kryžminis atsuktuvass Phillips / Skrūvgrieziis krusta PZ / Ristpeakruvikeeraja Pozidriv / Отвертка / Odvijač / Odvijac / Καταβίβι τύπου pozidriv / Destornillador philips / Giravite Pozzi 1000V / Chave de fenda de cruzeta / Tournevis en croix / Kriusschroevendraaier



Ref.	⊕	L[mm]	L ₁ [mm]	⊠	EAN
04-062	PZ1	190	80	12/240	5907558402056
04-063	PZ2	217	100	12/144	5907558402063

Ref.	⊕	L[mm]	L ₁ [mm]	⊠	EAN
04-136	PZ2	210	100	12/120	5907558433289

Wkrętaki 1000V

Screwdriver set / Schraubendreher / Отвертки / Відкрітки, набір / Csavarhúzókészlet / set şurubeliňiä / Šroubováky / Súprava skrutkovačov-bity / Komplet izvijačev / Atsuktuvų komplektas / Skrūvgriežu komplekts / Kruvikeerajate komplekt / Отвертки компл. / Odvijač / Odvijac set / Συλλογή καταβίβιδιών / Destornilladores / Set giraviti 1000V / Chaves de fenda / Tournevis / Schroevendraaiers

- ⌀ 2.5x75 mm, 4x100 mm, 6.5x150 mm
- ⊕ PH1x80 mm, PH2x100 mm



- ⌀ 3x100 mm, 4x100 mm, 5.5x125 mm, 6.5x150 mm, 8x175 mm
- ⊕ PH0x60 mm, PH1x80 mm, PH2x100 mm, PH3x150 mm



Ref.	⊠	EAN
04-220	6/36	5907558402278

Ref.	⊠	EAN
04-143	0/12	5907558433357

Wkrętaki 1000V

Screwdriver set / Schraubendreher / Отвертки / Відкртки, набір / Csavarhúzókészlet / set şurubelişte / Šroubováky / Súprava skrutkovačov+bity / Komplet izvijačev / Atsuktuvų komplektas / Skrivgriežu komplekts / Kruvikeerajate komplekt / Отвертки компл. / Одвијач / Одвијас set / Συλλογή κατασβιδιών / Destornilladores / Set giraviti 1000V / Chaves de fenda / Tournevis / Schroevendraaiers



- ⊖ 0.6x100mm, 0.8x100mm, 1.0x100mm, 1.2x100mm, 1.6x175mm
- ⊕ PH0x60 mm, PH1x80 mm, PH2x100 mm, PH3x150 mm

25 years GUARANTEE

S2 steel

1000V

+

+

x9

Ref.	⊞	EAN
04-142	0/12	5907558433340

Wkrętak plus-minus 1000V

Screwdriver / Kreuzschraubendreher / Отвертка крестовая / Відкртка хрестовидна / Csavarhúzó / şurubelişte / Šroubovák křížový / Skrutkovač / Křížni izvijač / Kryžminis atsuktuvus / Skrivgriežis krusta / Ristpeakruvikeeraja / Отвертка / Одвијач / Одвијас / Κατασβιδι σταυρωτό τύπου / Destornillador phillips / Giraviti / Chave de fenda de cruzeta / Tournevis en croix / Kriusschroevendraaier

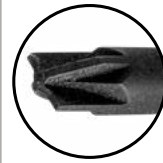

1000V

SVCM steel



Ref.	⊖ ⊕ ⊕	L[mm]	L ₁ [mm]	⊞	EAN
04-221	SL/PZ2	220	100	12/144	5907558432398
04-222	SL/PH2	220	100	12/144	5907558432404

Konektory

Electric connectors set / Steckverbinder-Set / Коннекторы набор / Конектори, набір / Kábelsarukészlet / Conectori set / Konektory súprava / Konektory / Komplet električnih priključkov / Elektros jungčių rinkinys / Elektrisko savienotāju komplekts / Elektripistikute komplekt / Комплект електрически съединители / Komplet električnih konektora / Комплект електричних конектора / Set ηλεκτρικών συνδετήρων / Juego de conectores eléctricos / Set di connettori / Conjunto de conectores eléctricos / Jeu de connecteurs électriques / Elektrische connectoren set

x420



Końcówki wkrętakowe z uchwytem 1000V

Screwdriver bits with holder / Einsätze für Schraubendreher mit Aufnahme / Набор насадок с держателем / Наконечники викртки, з ручіям / Csavarhúzó cserélhető fejű / Set biti cu suport carpat / Šroubovákové nástavce s držadlem / Skrutkovačie nástavce s upínadlom / Nastavki za izvijač z vpenjalom / Atsuktuvų antgaliai su laikikliu / Skrivgrieža uzgaļu komplekts ar turētāju / Kruvikeerajatsakud koos käepidemeaga / Нақрайніцы за отвертка с държач / Nastavci za odvijac s hvataljkom / Nastavci za odvijac s drškom / Σετ με κατασβιδιμιτες και προσαρμογεία / Puntas destornilladoras con mango / Set inserti con supporto / Ponteiros Chave de fenda com Suporte / Embouts de tournevis de précision avec manche / Schroevendraaiereindstukken met handvat

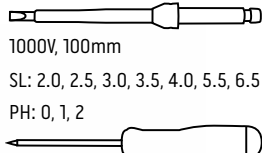

1000V, 100mm
SL: 2.0, 2.5, 3.0, 3.5, 4.0, 5.5, 6.5
PH: 0, 1, 2

1000V

S2 steel

QUICK CHANGE

54-61 HRC

x12

Ref.	⊞	EAN
01-308	0/20	5907558435597

1000V S2 steel 54-61 HRC x50



- ⊖ SL: 2.0 / 2.5 / 3.0 / 3.5 / 4.0 / 5.5 / 6.5
- ⊕ PH: PH0 / PH1 / PH2 ⊕ PZ: PZ0 / PZ1 / PZ2
- ⊕ T: T6 / T8 / T9 / T10 / T15 / T20 / T25 / T27 / T30
- ⊕ H: H2.5 / H3.0 / H4.0 / H5.0 / H6.0
- ⊕ R: R1 / R2
- ⊕ TRI: TRI 1 / TRI 2 / TRI 3 / TRI 4
- ⊕ TORO: TORO 4 / TORO 6 / TORO 8 / TORO 10
- ⊕ M: M4 / M5 / M6 ⊕ U: U4 / U6 / U8 / U10



1000V, 89mm

6.3 / 8.1

250 V

QUICK CHANGE

+

Ref.	⊞	EAN
01-309	0/10	5907558435603



Klucze nasadowe 1000V

Socket wrenches / Steckschlüssel / Набор сменных головок / Ключи торцевые / Dugókulcskészlet / Trusa tubulara / Nástrčné kľúče / Nástrčné kľúče / Nasadni ključji / Veržlerakció antgaliai / Nomaināmo galvu komplekts / Padrunvõtmed / Сменными наконечниками за ключовые / Nasadni ključevi / Ključevi natikači / Σετ με καρδιάκια / Llaves de vaso / Set di bussolle SuperLock / Chaves tubulares / Clefs à douilles / Dopsleutels



19
elements



8
elements

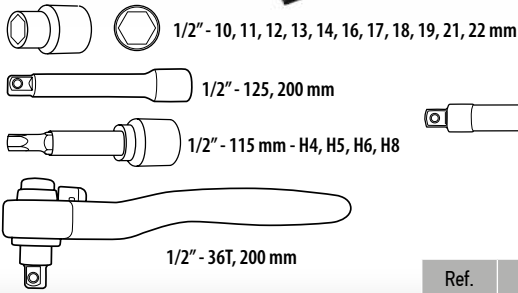

Ref.	☒	EAN
01-306	0/3	5907558435573

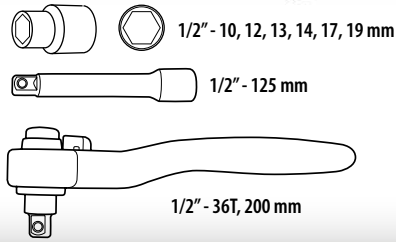

Ref.	☒	EAN
01-307	0/5	5907558435580

Skrzynia serwisowa elektryka 52 szt.

Electrician's tool box 52 pcs / Servicekasten für Elektriker 52-teilig / Инструментальный ящик электрика 52 шт. / Инструментальный ящик электрика 52 шт. / Villanyszerelő koffer, 52 db / Cutie scule electrician 52 piese / Elektrikářský servisní box 52 ks / Elektrikářská skrinka s náradím 52 ks / Servisni kovček elektrikařja 52 kos. / Įrankių dėžė elektrikui 52 vnt. / Elektriķa instrumentu kaste 52 gab. / Elektriku tööriistakast 52 tk / Κύφαρ c инструменти за електротехник 52 бр. / Servisni ormar za električara 52 kom. / Servisna kutija električara 52 kom. / Βολίτσα εργαλείων ηλεκτρολόγου 52 τμχ / Caja de servicio de eléctrico 52 uds. / Cassetta portautensili per elettricista 52 pz. / Kit de 52 ferramentas de electricista em caixa / Caisse à outil électricien / Gereedschapskoffer van elektricien 52 st.

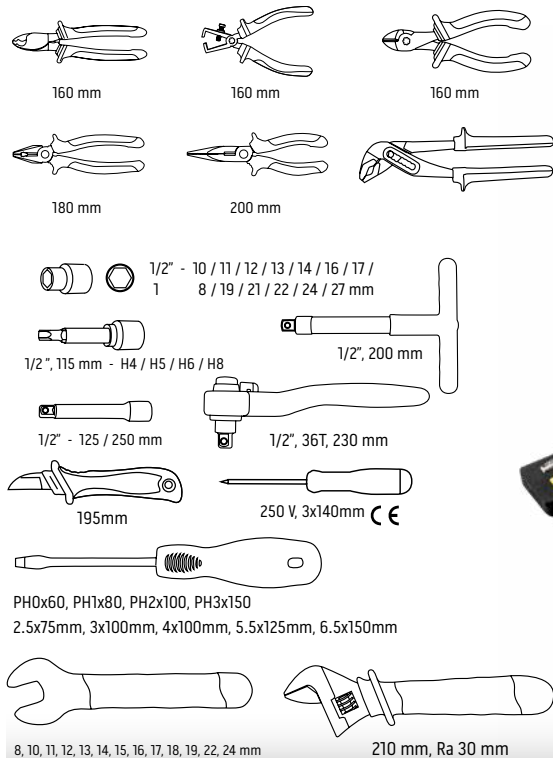

52
elements

Ref.	☒	EAN
01-311	0/1	5907558439991

Zestaw narzędzi izolowanych do aut elektrycznych

Insulated tool kit for electric cars / Isolierter Werkzeugsatz für Elektroautos / Изолированный набор инструментов для электромобилей / Изольований набір інструментів для електромобілів / Szigetelt szerszámkészlet elektromos autókhoz / Trusă de scule izolată pentru mașini electrice / Izolovaná sada nářadí pro elektromobily / Izolovaná súprava nářadia pre elektromobily / Izoliran komplet orodja za električne avtomobile / Izoliuotas elektrinių automobilių įrankių rinkinys / Izolēts instrumentu komplekts elektromobilijem / Isoleeritud tööriistakomplekt elektrautode jaoks / Изолиран комплект инструменти за електрически автомобили / Set izoliranih alata za električne automobile / Сет ізолованих алат за електричне аутомобиле / Σετ μονωμένων εργαλείων για ηλεκτρικά αυτοκίνητα / Kit de herramientas aislado para coches eléctricos / Kit di attrezzi isolati per auto elettriche / Geïsoleerde gereedschapset voor elektrische auto's / Kit d'outils isolés pour les voitures électriques



CRV steel **S2 steel** **8Cr14 steel** **51 elements** **1000V** **3/8"**

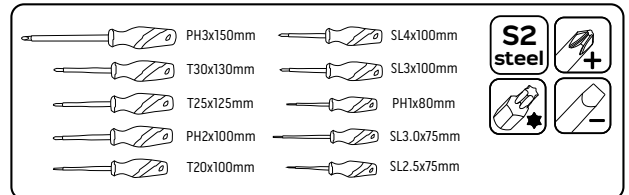
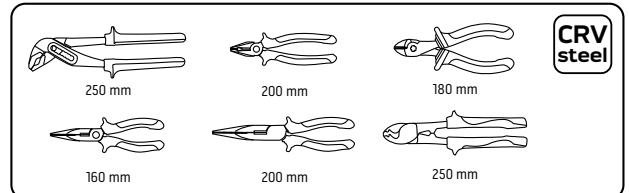
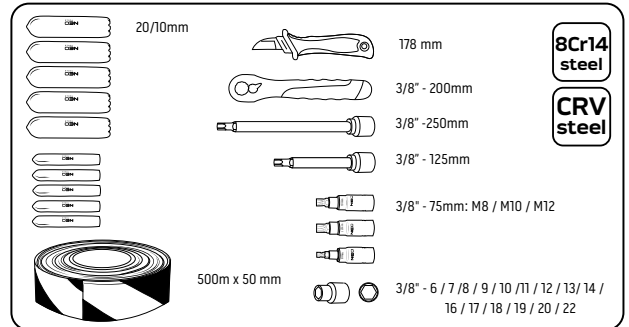

Ref.	☒	EAN
01-312	0/1	5907558493726



Szczypce uniwersalne

Combination pliers / Kombizange / Пассатижи / Пасатижи / Kombinált fogó / clește universal / Kombinované kleště / Kliešte kombinované / Kombinirane kleščice / Universalios replės / Plakanknaibles kombinētās / Universaalnäpitsad / Клеци комбинирани / Kombinirana klijesta / Kombinovana klesta / Πένσα γενικής χρήσης / Alicates universales / Pinza universale / Pinças universais / Pince universelle / Universele tang



Ref.	L[mm]	☒	EAN
01-010	160	6/48	5907558401547
01-011	180	6/48	5907558401554
01-012	200	6/48	5907558401561

Szczypce wydłużone proste

Combination pliers / Kombizange / Пассатижи / Пасатижи / Hosszúcsőrű fogó / clește universal / Kombinované kleště / Kliešte kombinované / Kombinirane kleščice / Universalios replės / Plakanknaibles kombinētās / Universaalnäpitsad / Клеци комбинирани / Kombinirana klijesta / Kombinovana klesta / Πένσα γενικής χρήσης / Alicates universales / Pinza a becco lungo / Pinças retas prolongadas / Pince allongée droite / Lange rechte tang



Ref.	L[mm]	☒	EAN
01-013	160	6/48	5907558401578
01-014	200	6/48	5907558401585



Ref.	L[mm]	☒	EAN
01-250	160	6/60	5907558443646
01-251	180	6/60	5907558443653



Ref.	L[mm]	☒	EAN
01-252	160	6/60	5907558443660
01-253	180	6/60	5907558443677

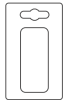

Ref.	L[mm]	☒	EAN
01-152	180	6/48	5907558448511
01-153	200	6/48	5907558448528

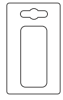

Ref.	L[mm]	☒	EAN
01-154	160	6/48	5907558448535
01-155	200	6/48	5907558448542

budowa głowicy oszczędza 40% siły przy standardowym nacisku
head design saves 40% of force with standard pressure
конструкция напору экономит 40% зусилля при стандартному тиску

budowa głowicy oszczędza 40% siły przy standardowym nacisku
head design saves 40% of force with standard pressure
конструкция напору экономит 40% зусилля при стандартному тиску



Ref.	L[mm]	☒	EAN
01-270	160	6/60	5906692015504
01-271	180	6/60	5906692015511
01-272	200	6/60	5906692015528



Ref.	L[mm]	☒	EAN
01-273	160	6/60	5906692015535
01-274	200	6/60	5906692015542

Szczypce wydłużone wygięte

Long nose bent pliers / Zange lang, gebogen / Плоскогубцы удлиненные изогнутые / Щипцы видовожени, вигнуты / Rövídcsőrű fogó / Cleste varf ascuțit indoit / Kleště prodloužené vyhnuté / Kliešte predĺžené vyhnuté / Koničaste klešče - upognjene / Prailgintos replės, lenktos / Izliektas pagarinātas knaibles / Pikkade kövurate otstega näpitsad / Клещи удължени огънати / Izdužena savinuta klijesta / Izdužena uvijena klešta / Μυροταιμίδα κυρτό / Alicates Teléfono curvo / Pinza a becco curvo / Pinças curvadas prolongadas / Pince allongée coudées / Lange gebogen tang



45°



Ref.	L[mm]	☒	EAN
01-015	160	6/48	5907558401592
01-016	200	6/48	5907558401608

45°



Ref.	L[mm]	☒	EAN
01-254	160	6/60	5907558443684
01-255	180	6/60	5907558443691

CARBON steel SLIM handle



Ref.	L[mm]	☒	EAN
01-277	160	6/60	5906692015573
01-278	200	6/60	5906692015580

Szczypce boczne

Diagonal cutting pliers / Seitenzange / Бокорезы / Бокорізи / Oldalcsípő fogó / clește ascuțit diagonal de tăiat sîrmă / Boční kleště / Cvikačky bočné / Stranske klešče / Šoninės replės / Sānknaibles / Diagonaal-löiketangid / Клещи Резачки / Klijesta cvikerice / Klesta poluokrugla / Πλαγιόκοφτες / Alicates diagonales / Tronchese laterale / Pinças laterais / Pince latérale / Zijtang

CARBON steel SLIM handle



Ref.	L[mm]	☒	EAN
01-275	160	6/60	5906692015559
01-276	190	6/60	5906692015566

Szczypce boczne

Diagonal cutting pliers / Seitenzange / Бокорезы / Бокорізи / Oldalcsípő fogó / clește ascuțit diagonal de tăiat sîrmă / Boční kleště / Cvikačky bočné / Stranske klešče / Šoninės replės / Sānknaibles / Diagonaal-löiketangid / Клещи Резачки / Klijesta cvikerice / Klesta poluokrugla / Πλαγιόκοφτες / Alicates diagonales / Tronchese laterale / Pinças laterais / Pince latérale / Zijtang



Ref.	L[mm]	☒	EAN
01-017	160	6/48	5907558401615
01-018	180	6/48	5907558401622



Ref.	L[mm]	☒	EAN
01-256	160	6/60	5907558443707
01-257	180	6/60	5907558443714

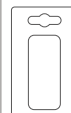

budowa głowicy oszczędza 40% siły przy standardowym nacisku
head design saves 40% of force with standard pressure
конструкция напору экономить 40% зусилля при стандартному тиску

Ref.	L[mm]	☒	EAN
01-156	160	6/48	5907558448559
01-157	180	6/48	5907558448566



budowa głowicy oszczędza 40% siły przy standardowym nacisku
head design saves 40% of force with standard pressure
конструкция напору экономить 40% зусилля при стандартному тиску

Ref.	L[mm]	☒	EAN
01-158	180	6/48	5907558448573

Szczypce okrągłe

Round nose pliers / Rundzange / Круглозубцы / Круглозубици / Kerekcsőrű fogó / clește rotund / Kulaté kleště / Kliešte s okružlou čelustou / Okrogle klešče / Арваліос рэплэс / Αραχκναίβλες / Ümarmokk-näpitsad / Клеци Чооки / Kliješta okrugla / Klesta okrugla / Μιστοσίμυδο με στρογγυλά ράμφη / Alicates redondos / Pinza a becco tondo / Pinças redondas / Pince ronde / Ronde tang



Ref.	L[mm]	⊠	EAN
01-020	160	6/48	5907558401646

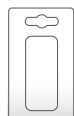

CARBON steel SLIM handle



Ref.	L[mm]	⊠	EAN
01-280	160	6/60	5906692015603

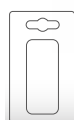

Szczypce z podwójnym przegubem

Double jointed pliers / Плоскозубици з подвійним шарніром / Clește cu articulație dublă / Dupla csuklás fogó / Pinze a doppio snodo / Pince à double articulation / Doppelgelenkige Zange / Плоскозубици с двоїм шарніром / Kliešte s dvojitým kloubem / Kliešte s dvojitým klbom / Kliješta za duple spojeve / Dvigubo sujungimo replės / Dubultā savienojuma knaibles / Klešče z dvojnim spojem / Двоіно с'єдинени клеци / Двострука клешта / Πένσα διπλής άρθρωσης / Dubbelgebroken tang / Alicate de articulação dupla / Alicates de doble articulación / Topeltühendusega tangid



CRV 330 mm 3pcs

Ref.	L[mm]	⊠	EAN
01-293	330	1/16	5906692018819

Szczypce precyzyjne płaskie

Precision flat pliers / Präzisionszange flach / Плоскозубици прецизионные / Плоскозубици прецизійні пласки / Laposcsőrű fogó / Clește plat / Kliešte jemná mechanika / Kliešte ploché mikro / Ploske klešče, precizne / Ploščios replės tiksliams darbams / Plakanaknaibles / Täppislamemokk-näpitsad / Клеци чооки / Kliješta plosnata / Klesta pljosnata / Πλατυσίμυδο ακριβείας γενικής χρήσης / Pinza di precisione a becco piatto / Pinças precisas planas / Pince de précision à fourches / Precisie vlakke tang



Ref.	L[mm]	⊠	EAN
01-105	130	6/96	5907558401714



Szczypce płaskie

Flat nose pliers / Zange flach / Плоскозубици / Щипци з плоскими зубками / Laposcsőrű fogó / Clește varf plat / Kleště ploché / Kliešte ploché / Ploščios replės / Ploščios replės / Plakanas knaibles / Lamenäpitsad / Плоско клеци / Plosnata kliješta / Ravna klešta / Πένσα / Alicate Boca plana / Pinza a becco piatto / Pinças planas / Pince à fourches / Vlakke tang



Ref.	L[mm]	⊠	EAN
01-019	160	6/48	5907558401639



CARBON steel SLIM handle



Ref.	L[mm]	⊠	EAN
01-279	160	6/60	5906692015597



Szczypce z podwójnym przegubem

Double jointed pliers / Плоскозубици з подвійним шарніром / Clește cu articulație dublă / Dupla csuklás fogó / Pinze a doppio snodo / Pince à double articulation / Doppelgelenkige Zange / Плоскозубици с двоїм шарніром / Kliešte s dvojitým kloubem / Kliešte s dvojitým klbom / Kliješta za duple spojeve / Dvigubo sujungimo replės / Dubultā savienojuma knaibles / Klešče z dvojnim spojem / Двоіно с'єдинени клеци / Двострука клешта / Πένσα διπλής άρθρωσης / Dubbelgebroken tang / Alicate de articulação dupla / Alicates de doble articulación / Topeltühendusega tangid

CRV 330 mm



Ref.	L[mm]	⊠	EAN
01-290	330	5/40	5906692018789
01-291	330	5/40	5906692018796
01-292	330	5/40	5906692018802

Szczypce precyzyjne czołowe

Precision end cutter pliers / Stirpräzisionszange / Кусачки торцевые прецизионные / Бокорізи прецизійні / Homlokcsipő fogó / clește frontal / Kliešte čelní jemná mechanika / Cvikacky čelné mikro / Stranske klešče, precizne / Žnyplės tiksliams darbams / Knaibles / Täppisnäpitsad oste löikamiseks / Клеци резачки / Kliješta cvikerice / Klesta sevice / Εμπροσθοκόφης ακριβείας / Alicates frontales de precisión / Tenaglia di precisione / Pinças precisas frontais / Pince de précision frontale / Precisie hoofdtang

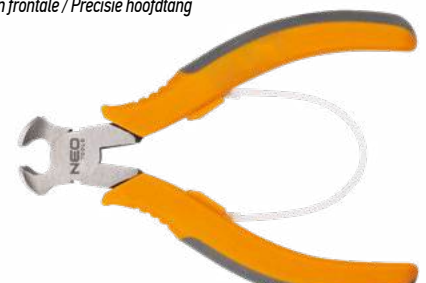

Ref.	L[mm]	⊠	EAN
01-101	115	6/96	5907558401677



Szczypce precyzyjne wydłużone proste

Precise long nose straight pliers / Feinzange, lang, gerade / Плоскогубцы прецизионные удлиненные / Щипці прецизійні, з видовженими, прямими губками / Hosszúcsőrű fogó / Cleste precizie-varf lung / Kleště precizní prodloužené rovné / Kliešte precízne predĺžené rovné / Precizne ravne podaljšane klešče / Prailgintos precizinės replės, tiesios / Pagarinātas precīzējošas plakanknaibles / Pikkade otstega peennäpitsad / Прецизну удължени клещи / Precizna izdužena jednostavna kliješta / Precizna ravna izdužena klešta / Μυτοσίμπιδο ακριβείας / Alicate puntas redondas larga / Pinza di precisione a becco lungo / Pinças precisas prolongadas retas / Pince de précision allongée droite / Lange rechte pecisie tang

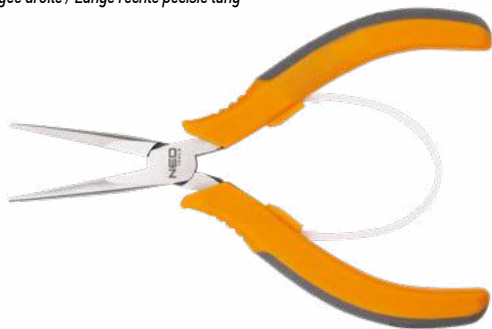

Ref.	L[mm]	⊠	EAN
01-102	130	6/96	5907558401684

Szczypce precyzyjne wydłużone wygięte

Precise long nose bent pliers / Feinzange, lang, gebogen / Плоскогубцы прецизионные удлиненные изогнутые / Щипці прецизійні, з видовженими, вигнутими губками / Rövidcsőrű fogó / Cleste precizie-varf indoit / Kleště precizní prodloužení vyhnuté / Kliešte precízne predĺžené vyhnuté / Precizne podaljšane upognjene klešče / Prailgintos precizinės replės, tiesios / Izlektas pagarinātas precīzējošas plakanknaibles / Pikkade kõverate otstega peennäpitsad / Прецизну удължени огънати клещи / Precizna izdužena savinuta kliješta / Precizna uvijena izdužena klešta / Μυτοσίμπιδο ακριβείας κυρτό / Alicates puntas curvas larga / Pinza di precisione a becco curvo / Pinças precisas prolongadas curvadas / Pince de précision allongée coudées / Lange gebogen precisie tang



Ref.	L[mm]	⊠	EAN
01-103	140	6/96	5907558401691

Szczypce precyzyjne boczne

Precision diagonal pliers / Seitenpräzisionszange / Бокорезы прецизионные / Пласкогубци прецизійні діагональні / Oldalcsipő fogó / Clešte diagonal / Kleště boční jemná mechanika / Cvikáčky bočné mikro / Čelne klešče, precizne / Šoninēs replēs tikslīems darbamš / Sānknaibles / Diagonaal-tāppisnāpitsad / Клещи резачки / Kliješta cvikerice / Klesta secice / Πλαγκοκάπτης ακριβείας / Alicates diagonales de precisión / Tronchese laterale di precisione / Pinças precisas laterais / Pince de précision latérale / Precisie zijtang

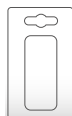

Ref.	L[mm]	⊠	EAN
01-106	110	6/96	5907558401721



Ref.	L[mm]	∅ [mm]	⊠	EAN
01-509	140	0,8 - 2,6	10/50	5907558439281

Szczypce czołowe

End cutting pliers / Frontzange / Нусачки торцовые / Щипці торцеві / Homlokcsipő fogó / Cleste taiere frontala / Kleště čelní / Kliešte čelné / Čelne klešče / Kandiklēs / Kniebjamās knaibles / Otsnāpitsad / Клещи челны / Čeona kliješta / Čeona klešta / Τανάλια / Alicate de corte frontal / Tenaglia / Pinças frontais / Pince frontale / Hoofdtang



Ref.	L[mm]	⊠	EAN
01-021	160	6/48	5907558401653
01-022	200	6/48	5907558401660

Obcęgi do gwoździ

Carpenters pincers / Beißzange / Клещи для гвоздей / Ηαράπό fogó / clešte dulgher / Štirpaci kleště / Cvikáčky čelné / Mizarske klešče / Žnyplēs vinims / Naglu stangas / Piušepa nāpītstangid / Клещи керпеден / Stolarska Kliješta / Stolarska klesta / Τανάλια Μαραγκού / Tenazas para clavos / Tenaglia da carpentiere / Turqueses p. Pregas / Tenailles à clous / Spijkertang



Ref.	L[mm]	⊠	EAN
01-151	180	6/48	5907558411720
01-150	200	6/48	5907558406054

Szczypce do pierścieni osadczyc

Circlip pliers / Zange für Stellringe / Щипцы для стопорных колец / Щипцы для стопорных колец / Zégergyűrű fogó / set clește cu spirală / Kleště pro stavěcí kroužky / Segerky vonkajšie rovné / Klešče seger / Replés ziedams / Sprostgredzenu stangas / Vedrunāpītsad / Клещи Зееер / Kružna Klješta / Kružna klesta / Ασφαλειοταιμιπέδες / Alicates para anillos de asiento / Pinza per anelli elastici / Pinças p. Anéis / Pince pour bagues de retenue / Tang voor dopringen



zewewnętrzne proste
external, straight tip
зовнішні/прости щипці



Ref.	L[mm]	Ra[mm]	☒	EAN
01-085	150	10-25	6/48	5907558440584
01-087	180	19-60	6/48	5907558440607
01-089	230	40-100	6/36	5907558440621



wewnętrzne proste
internal, straight tip
внутрішні/прости щипці



Ref.	L[mm]	Ra[mm]	☒	EAN
01-086	150	10-25	6/48	5907558440591
01-088	180	19-60	6/48	5907558440614
01-090	230	40-100	6/36	5907558440638



zewewnętrzne wygięte
external, bent tip
зовнішні/выгнуті щипці



Ref.	L[mm]	Ra[mm]	☒	EAN
01-091	145	10-25	6/48	5907558440645
01-093	170	19-60	6/48	5907558440669
01-095	220	40-100	6/36	5907558440683



wewnętrzne wygięte
internal, bent tip
внутрішні/выгнуті щипці



Ref.	L[mm]	Ra[mm]	☒	EAN
01-092	145	10-25	6/48	5907558440652
01-094	170	19-60	6/48	5907558440676
01-096	220	40-100	6/36	5907558440690

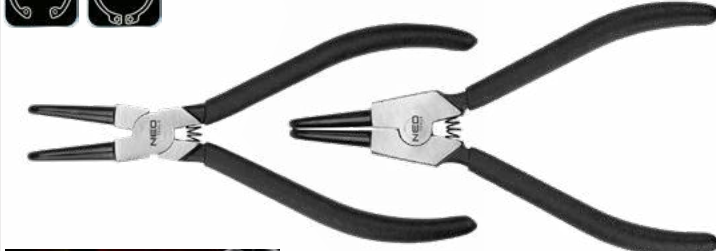

Ref.	L[mm]	Ra [mm]	☒	EAN
01-097	170/180	19-60	4/16	5907558463606

Szczypce zaciskowe

Locking pliers / Klemmzange / Клещи зажимные / Πασκωζυβίι obtuskní / Patentfogó / clește fixator / Upináci kleště / Kliešte fixačné univerzálne / Prijemne klešče / Užspaudimo replės / Fiksātorstangas / Lukustustangid / Клещи Чирак / Stop klješta / Smrt klesta / Πένιας - Γκρίπ / Tenazas grip / Pinza a scatto dritta / Pinças para grampear / Pince de serrage / Krimptang



Ref.	L[mm]	Ra[mm]	☒	EAN
01-216	250	0-47	6/36	5907558409185



Ref.	L[mm]	Ra[mm]	☒	EAN
01-217	250	0-45	6/36	5907558409192

Szczypce blacharskie

Axial grip locking pliers / Klemmzange / Клещи зажимные / Плоскозубци обтискни / Patentfogó / Clește fixator / Upínací kleště / Kliešte fixačné univerzálne / Prijemne klešče / Užspaidimo replės / Fiksátorstangas / Lukustustangid / Клещи чирак / Stop klijesta / Smt klesta / Πένσες - γκριπ / Tenazas grip / Pinza griffante / Pinças para grampear / Pince de serrage / Krimptang



Szczypce uniwersalne 1000V

Combination pliers / Kombizange / Пассатижи / Пасатижи / Kombinált fogó / clește universal / Kombinované kleště / Kliešte kombinované / Kombinirane klešče / Universalios replės / Plakanknaibles kombinētās / Universālnāpītsad / Клещи комбинирани / Kombinirana klijesta / Kombinovana klesta / Πένσα γενικής χρήσης / Alicates universales / Pinza universale 1000V / Pinças universais / Pince universelle / Universele tang



Szczypce wydłużone proste 1000V

Long nose pliers / Gerade Zange, verlängert / Плоскозубци удлинённые прямые / Плоскозубци з видовженими зубцями / Hosszúcsőrű fogó / Clește ascuțit bine / Kliešte prodĺoužené rovné / Kliešte špicaté rovné / Koničaste klešče / Replės pailgintos, tiesios / Plakanknaibles pagarinātās taisnās / Pikkmokk-nāpītsad / Клещи Чоюк / Flah Klijesta / Flah klesta / Μυτοστόμιο μακράκι ράμφη / Alicates largos rectos / Pinza a becco lungo 1000V / Pinças retas prolongadas / Pince allongée droite / Lange rechte tang

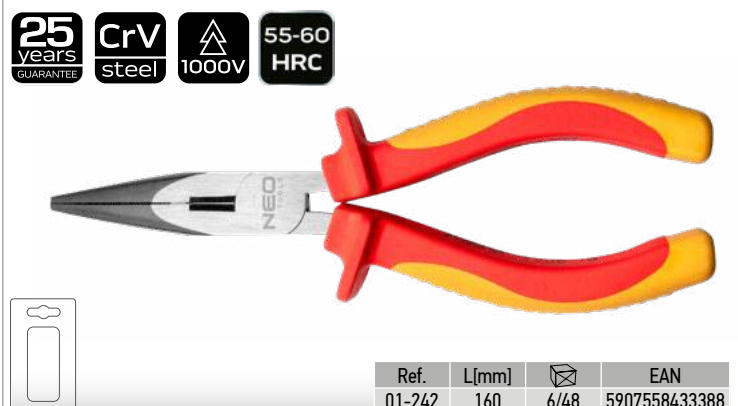
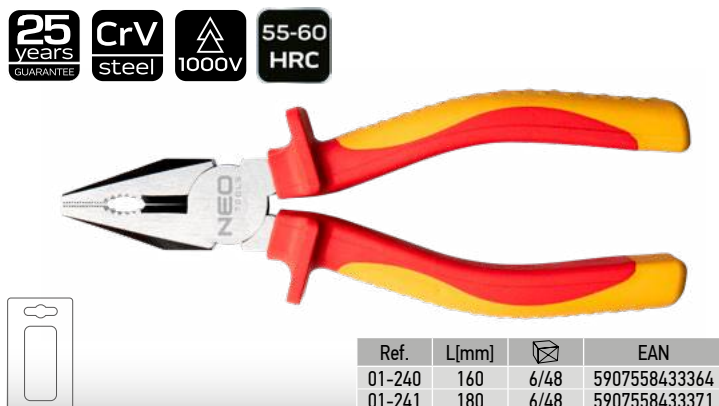
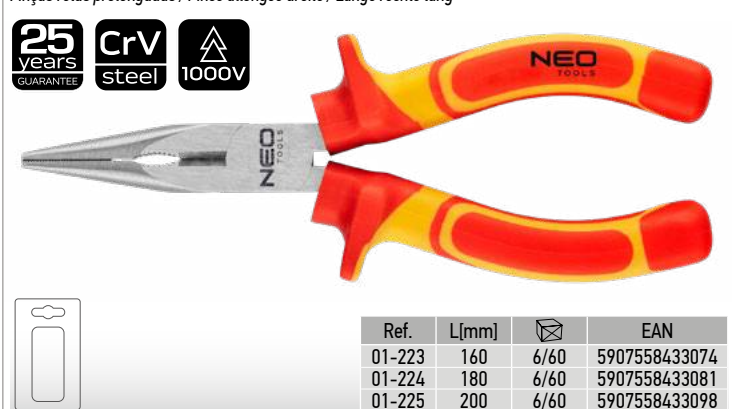

Szczypce wydłużone wygięte 1000V

Long nose bent pliers / Zange lang, gebogen / Плоскогубцы удлиненные изогнутые / Ципци видоизменени, вигнути / Hajlított csőrű fogó / Ceste varf ascuțit indoit / Kleště prodloužené vyhnuté / Klešte predĺžené vyhnuté / Koničaste klešče - upognjene / Prailgintos replės, lenktos / Izliektas pagarinātas knaibles / Pikkade kõverate otstega näpitsad / Клещи удлинённые оогнату / Izdužena savinuta klijesta / Izdužena uvijena klešta / Μυταταιµίδο κυρτό / Alicate Teléfono curvo / Pinza universale 1000V / Pinças curvadas prolongadas / Pince allongée coudées / Lange gebogen tang



Ref.	L[mm]	⊠	EAN
01-227	160	6/60	5907558433111
01-228	180	6/60	5907558433128

Szczypce do rur 1000V

Water pump pliers / Rohrzange / Клещи трубные / Ключи трубни / Vízpumpa fogó / ceste p/u pompa de apă / Kleště na trubky / Hasák / Cevne klešče / Replės vamzdžiams / Rorstangas / Veepumba tangid / Клещи Гаража / Klijesta papige / Klesta parapaj / Γκαζοταιάλια / Tenazas para tubos / Pinza giratubi 1000V / Pinças p. Tubos / Pince pour tubes / Buistang



Ref.	L[mm]	⊠	EAN
01-232	250	6/36	5907558433166

Szczypce boczne 1000V

Diagonal cutting pliers / Seitenzange / Бокорезы / Бокорізи / Oldalsípő fogó / ceste ascuțit diagonal de tăiat sîrmă / Боční kleště / Cvikačky bočné / Stranske klešče / Šoninės replės / Sānknaibles / Diagonaal-lōiketangid / Клещи Резачки / Klijesta cvikerice / Klesta poluokruga / Πλαγκοκόφτες / Alicates diagonales / Tronchese laterale 1000V / Pinças laterais / Pince latérale / Zijtang



Ref.	L[mm]	∅ [mm]	⊠	EAN
01-525	160	1.5; 2.5	0/36	5907558404340



Ref.	L[mm]	⊠	EAN
01-226	160	6/60	5907558433104

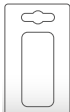
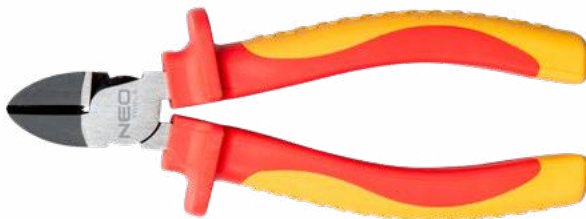

Ref.	L[mm]	⊠	EAN
01-243	160	6/48	5907558433395

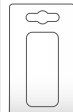

Ref.	L[mm]	⊠	EAN
01-231	180	6/60	5907558433159



Ref.	L[mm]	⊠	EAN
01-244	180	6/48	5907558433401

Szczypce do cięcia kabli 1000V

Cable cutter / Kabelabschneider / Кабелерез / Обрізувач для кабелю / Kábelvágó fogó / Ceste pentru tăiat cabluri / Kleště na kabely / Kliešte na káble / Nož za rezanje kablov / Kandikles kabeliui / Kabeļu griezējs / Kaablilõikur / Резачка за кабелу / Rezač kablova / Nož za rezanje kablova / Κόφτης καλωδίων / Alicate cortacables / Taglia cavo 1000V / Cortador p. Cabos / Coupe-câbles / Knipper voor kabels

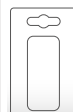

Ref.	L[mm]	⊠	EAN
01-233	160	6/60	5907558433173

Szczypce do izolacji 1000V

Wire stripper / Isolierungszange / Бокорезы для зачистки / Бокорізи для зачищування / Kábelcsupaszóló / clește p/ú înlăturarea izolatoarelor / Kleště na izolaci / Kliešte odizolovacie / Klešče za snemanje izolacije / Replés izolációjai nuimti / Knaibles izolácijs / Kaablitangid / Клещи Загопвачки за монтаж / Klesta za izolaciju / Απογυμνωτές καλωδίων / Alicates pelacables / Pinza spela fili regolabile 1000V / Pinças p. Isolação / Pince à dénuder / Isolatietang



Ref.	L[mm]	Ø [mm ²]	⊠	EAN
01-245	160	0.2 - 6.0	6/48	5907558433418



Ref.	L[mm]	Ø [mm ²]	⊠	EAN
01-229	160	0.2 - 6.0	6/60	5907558433135

Zestaw narzędzi 1000V

Tools set / Werkzeugsatz / Набор инструментов / Набор інструментів / Szerszámkészlet / Set scule de grădină / Sada nářadí / Súprava nářadia / Garnitura orodja / Įrankių komplektas / Instrumentu komplekts / Tööriistakomplekt / Гедоре комплект / Set uređaja / Set alata / Συλλογή εργαλείων / Juego de herramientas / Set attrezzi 1000V / Kit de ferramentas / Jeu d'outils / Gereedschapsset



⊖ 5.5x125 mm ⊕ PH1x80

Ref.	⊠	EAN
01-237	0/8	5907558433210

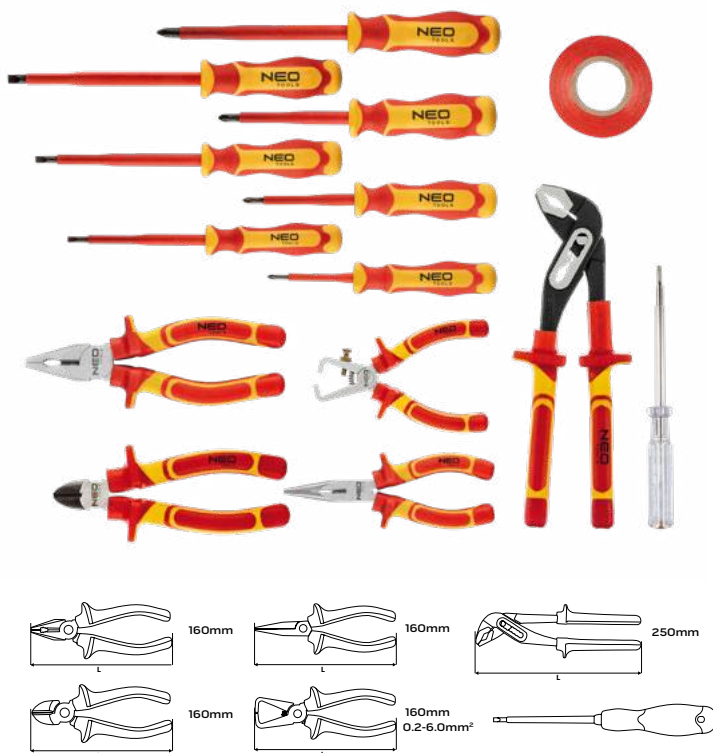

⊖ 1.0 x 5.5 x 125 mm; 0.8 x 4 x 100 mm; 1.0 x 6.5 x 150 mm
 ⊕ PH0 x 3 x 60 mm; PH2 x 6 x 100 mm;
 PH1 x 4.5 x 80 mm; PH3 x 8 x 150 mm

Ref.	⊠	EAN
01-234	0/6	5907558433180

Zestaw narzędzi 1000V

Tools set / Werkzeugsatz / Набор инструментов / Набор інструментів / Szerszámkészlet / Set scule de grădină / Sada náradí / Súprava náradia / Garnitura orodja / Įrankių komplektas / Instrumentu komplekts / Тööriistakomplekt / Тедор комплент / Set uređaja / Set alata / Συλλογή εργαλείων / Juego de herramientas / Set attrezzi 1000V / Kit de ferramentas / Jeu d'outils / Gereedschapsset

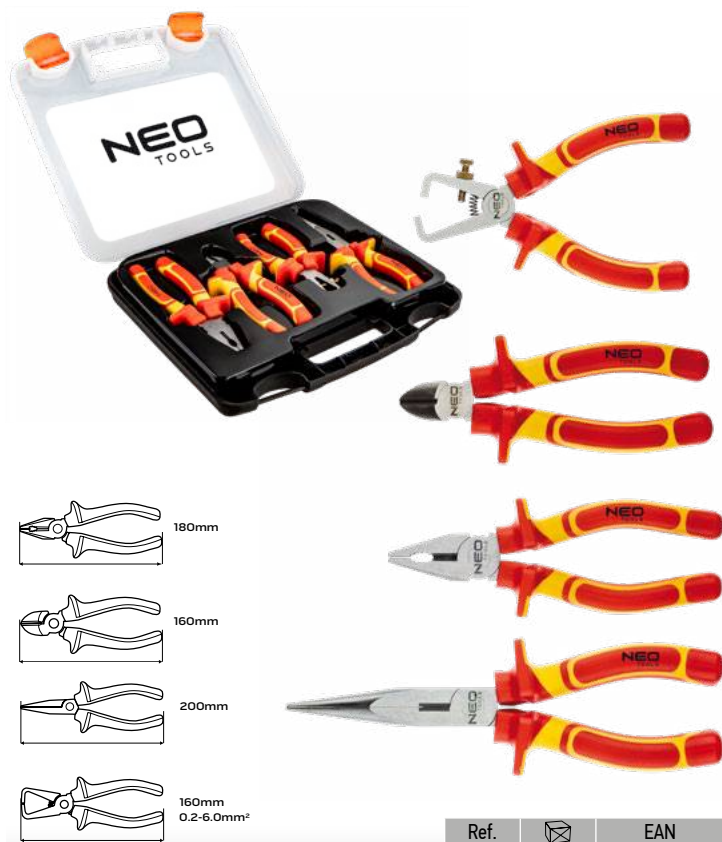

Ref.	☒	EAN
01-236	0/8	5907558433203

Nóż monterski 1000V

Fitter's knife / Monteurmesser / Нож монтерский / Ніж монтерський / Kábelvágó kés / Cutit pentru cabluri / Nůž montérský / Montérsky nôž / Montažni nož / Montuotojo peilis / Montiera nazis / Elektrikunuga / Монтьорски нож / Monterski nož / Monterski nož / Μαχαίρι ηλεκτρολόγου / Cuchillo recto para cables / Coltello per elettricisti / Faca p. montagem / Couteau de monteur / Montagemes



Ref.	☒	EAN
01-552	10/100	5907558497410

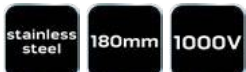

Ref.	☒	EAN
01-553	10/100	5907558497427

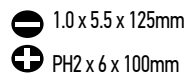
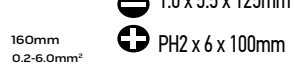
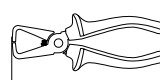
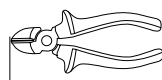
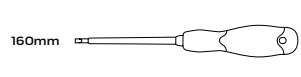
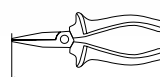
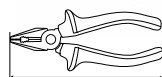

Ref.	☒	EAN
01-235	0/6	5907558433197

Szczypce do zaciskania końcówek

Crimping pliers / Feinzunge, zur Verklebung der Endungen / Клещи для обжима кабельных наконечников / Щипци кабельни, замучни / Kábelсарu fogó / Cleste pentru sertizat/conectori / Kleště na svírání koncovek / Kliešte na koncovky / Klešče za stiskanje konic / Replés, antgalių užspaudimui / Knaibles kabelų uzgali suspiešanai / Otsakinnitusnäpitsad / Клещи за притискане на краища на кабели / Kliešta za pritiskanje nastavaka / Klešta za pričvršćivanje krajeva / Πέσσα ακροδεκτών / Pinzas de presión para puntas / Pinza per terminali / Pinças p. Grampear pontas / Pince universelle de serrage d'embouts / Tang voor eindstukken



1200 pcs

205 mm

- E0508 - x200 - 0.5 mm²
- E7508 - x200 - 0.75 mm²
- E1008 - x200 - 1.0 mm²
- E1508 - x250 - 1.5 mm²
- E2508 - x250 - 2.5 mm²
- E4009 - x50 - 4.0 mm²
- E6012 - x25 - 6.0 mm²
- E10-12 - x25 - 10.0 mm²

Ref.	☒	EAN
01-562	1/24	5906692019502

Ściągacz izolacji

Wire stripper / Abziehvorrichtung für Isolierung / Съемник изоляции / Знімач ізоляції / Kábelcsupaszoló / Dispozitiv de scos izolația / Stahovač izolace / Kliešte na stahovanie izolácie / Snemalnik izolacije / Izolācijas nuņēmimo replēs / Izolācijas noņēmējs / Isolatsioonitõmmits / Изолупаща скоба / Skidač izolacije / Skidač izolacije / Εργαλείο για αφαίρεση μόνωσης / Alicates pelacables / Spelafili universale / Ponta de aperto de isolação / Dénudeur d'isolation / Trekker voor isolatie

25
years
GUARANTEE

ABS

TPR

SK5
steel

0.34-6.0
mm²

RG6/S9
8-13 mm²



Ref.	L[mm]	⊠	EAN
01-524	125	15/90	5907558415643

8-28
mm 190
mm



Ref.	L[mm]	⊠	EAN
01-547	190	20/100	5907558421835

PP CUTTING DEPTH 0-5 mm ⌀ min 25 mm



Ref.	L[mm]	⊠	EAN
01-400	170	0/40	5907558449617

STEEL ABS 165mm ⌀ min 8-28mm



Ref.	L[mm]	⊠	EAN
01-546	165	20/100	5907558499735

stainless steel 6in1 180 mm two component handle



Ref.	L[mm]	⊠	EAN
01-549	180	10/100	5907558421859

Automatyczny ściągacz izolacji

Automatic wire stripper / Automat. Abziehzange / Съемник изоляции автоматический / Автоматичний стягач ізоляції / Kábelcsupaszoló automata / Clește automatic p/u extragerea izolației / Automatické stahovadlo izolace / Kliešte odizolovacie automatické / Klešče za snemanje izolacije / Automatinis izolācijas nuimtvas / Stangas izolācijas noņēmēšanai automātiskās / Automaatsed kaablitangid / Клеши загольвачки / Klijesta za izolaciju / Klesta za izolaciju / Αυτόματος απομυμνωτής καλωδίων / Alicates pelacables automáticos / Spelafili automatico / Aparelho automático de remover isolação / Dénudeuse d'isolation automatique / Automatisch draadstriptang

SK5
steel

0.34-6.0
mm²

CUTTER



Ref.	L[mm]	⊠	EAN
01-519	195	10/60	5907558415599



SK5
steel

TPR

ABS

1.0, 1.6, 2.0, 2.6, 3.2 mm²

Ref.	L[mm]	⊠	EAN
01-520	170	8/48	5907558415605

25 years GUARANTEE 0.5-6.0 mm 22-10 AWG 52-57 HRC 55-60 HRC



Ref.	L[mm]	⊠	EAN
01-500	205	10/60	5907558403190

TPR
ABS

0.5-6.0
mm

CUTTER



Ref.	L[mm]	⊠	EAN
01-534	180	10/40	590755843935

Automatyczny ściągacz izolacji

Automatic wire stripper / Automat. Abziehzange / Съемник изоляции автоматический / Автоматичний стягувач ізоляції / Kábelcsupaszoló automata / Clește automatic p/u extragerea izolației / Automatické stahovadlo izolace / Kliešte odizolovacie automatické / Klešče za snemanje izolacije / Automatinis izoliacijos nuimtuvas / Stangas izolācijas noņemšanai automātiskās / Automaatsed kaablangid / Клеици заголювачки / Klijesta za izolaciju / Klesta za izolaciju / Αὐτόματος απομυμνωτής καλωδίων / Alicates pelacables automáticos / Spelafili automatico / Aparelho automático de remover isolação / Dénudeuse d'isolation automatique / Automatisch draadstriptang



Szczypce do zaciskania końcówek

Crimping pliers / Feinzunge, zur Verklemmung der Endungen / Клеици для обжима кабельных наконечников / Щипци кабельні, затисні / Kábelcsarú fogó / Clește pentru sertizat/conectori / Kliešče na svíráni koncovek / Kliešte na koncovky / Klešče za stiskanje konic / Replés, antgaliú užspaudimui / Knaibles kabelu uzgalu saspišanai / Otsakinnitusnäpitsad / Клеици за притискане на краища на кабели / Klijesta za pritiskanje nastavaka / Klešta za pričvršćivanje krajeva / Πένσα ακροδεκτών / Pinzas de presión para puntas / Pinza per terminali / Pinças p. Grampear pontas / Pince universelle de serrage d'embouts / Tang voor eindstukken



Szczypce do zaciskania końcówek

Crimping pliers / Feinzunge, zur Verklammerung der Endungen / Клещи для обжима кабельных наконечников / Щипці кабельні, затиски / Kábelcsaru fogó / Cleste pentru sertizat/conectori / Kleště na svíráni koncovek / Kliešte na koncovky / Klešče za stiskanje konic / Replés, antgaliž užspaudimui / Knaibles kabelu uzgaļu saspišana / Otsakinnitusnäpitsad / Клещи за притискане на краища на кабелу / Klješta za pritiskanje nastavaka / Klešta za pričvršćivanje krajeva / Πένσα ακροδεκτών / Pinzas de presión para puntas / Pinza per terminali / Pinças p. Grampear pontas / Pince universelle de serrage d'embouts / Tang voor eindstukken



25 years GUARANTEE

0.25-2.5 mm²

1.5-6.0 mm²

Ref.	L[mm]	⊠	EAN
01-532	140	20/80	5907558432367
01-533	140	20/80	5907558432374



25 years GUARANTEE

TÜV Rheinland CERTIFIED

22-10 AWG

52-57 HRC

NEO TOOLS

Ref.	L[mm]	⊠	EAN
01-503	250	6/36	5907558403213



25 years GUARANTEE

PV PHOTO VOLTAIC

MC4 connector

2.5 / 4 / 6 mm²

NEO TOOLS

Pozycjoner w zestawie
Positioner included
Позиційник включений

Ref.	L[mm]	⊠	EAN
01-555	270	10/20	590206203427



25 years GUARANTEE

RG 6

RG 58

RG 59

RG 62

NEO TOOLS

AWG 16-10 1.5 - 6 mm²

AWG 17-10 1 - 6 mm²

AWG 17-10 1 - 6 mm²

AWG 10-6 6 - 16 mm²

AWG 20-10 0.5 - 6 mm²

Ref.	L[mm]	⊠	EAN
01-537	220	0/5	5907558439304



200mm

0.1-16 mm²

two components handle

NEO TOOLS

Ref.	L[mm]	⊠	EAN
01-548	200	10/40	5907558421842



25 years GUARANTEE

EASY SIZE CHANGING

SOFT HANDLE

6-50 mm²

NEO TOOLS

Ref.	L[mm]	⊠	EAN
01-530	390	0/10	5907558432343



25 years GUARANTEE

EASY SIZE CHANGING

SOFT HANDLE

10-120 mm²

NEO TOOLS

Ref.	L[mm]	⊠	EAN
01-531	610	0/5	5907558432350

Praska ręczna hydrauliczna do końcówek elektrycznych

Hydraulic hand press for electric bits / Hydraulische Handpresse für Elektroböhrer / Гидравлический ручной пресс для электросверл / Прес гидравлический ручной для электрических долбит / Hidraulikus kézi sajító elektromos bitekhez / Presă hidraulică manuală pentru biți electrice / Hydraulický ruční lis pro elektrické bity / Hydraulický ručný lis pre elektrické bity / Hidraulična ročna stiskalnica za električne svedre / Hidraulinis rankinis presas elektriniams gražtams / Hidrauliskā rokas prese elektriskajiem bitiem / Гидравлическая ручная преса за електрически бита / Υδραυλική πρέσα χειρός για ηλεκτρικά εργαλεία / Pressa manuale idraulica per punte elettriche / Prensa manual hidráulica para brocas eléctricas / Prensa manual hidráulica para brocas eléctricas / Presse hydraulique à main pour mèches électriques / Hydraulische handpers voor elektrische bits



Ref.	[mm ²]	⊠	EAN
01-543	16-300	0/4	5907558485523

Nożyce do kabli i izolacji

Cable and insulation cutter / Schere für Kabel und Isolierung / Ножницы для кабеля и изолирующей оболочки / Ножници по кабелю и изоляції / Kábelvágógólló / Foarfeca taiat/dezizolat cabluri / Nůžky na kabely a na izolaci / Nožnice na káble a izolácie / Škarje za kable in izolacijo / Žirkles kabeliui ir izoliacijai / Šķēres kabeliem un izolācijai / Kaabli- ja isolatsioonikäärid / Ножниця за кабелю и ізоляція / Škare za kablove i izolaciju / Makaze za kablove i izolaciju / Ψαλίδι καλωδίων και μόνωσης / Tijeras de electricista / Forbice da elettricista / Tesoura para cabos e isolação / Cisaille à câbles et isolation / Schaar voor kabels en isolatie

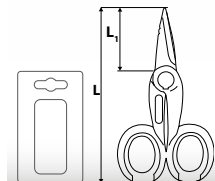

Ref.	L[mm]	L ₁ [mm]	⊠	EAN
01-511	140	45	12/72	5907558405378

Obcinak do drutów

Cable wire cutter / Abschneider für Draht / Кабелперез / Обрізувач до дротів / Drótvágó fogó / Cleste taiat cabluri / Klešče na drát / Klešče cvikacije na káble a ocelové laná / Nož za žice in jeklenice / Kandiklės vielai ir plieniniam lynui / Stieplu vai tērauda auklu griezējs / Traadi- ja terasjuhtmelõikur / Резачка за тел истоманени въжета / Rezač za žice i čelične sajle / Nož za žicu i čeličnu užad / Κόφτης καλωδίων / Alicate para cortar cable trenzado / Troncatrice per filo / Cortador de arames / Coupe-fils / Knipper voor draad



Ref.	L[mm]	⊠	EAN
01-518	210	6/48	5907558413007

Obcinak do kabli

Cable cutter / Kabelabschneider / Кабелперез / Обрізувач для кабелю / Kábelvágó / Cleste pentru taiat cabluri / Klešče na kabely / Klešče na káble / Nož za rezanje kablov / Kandiklės kabeliui / Kabelu griezējs / Kaabliõikur / Резачка за кабелю / Rezač kablova / Nož za rezanje kablova / Κόφτης καλωδίων / Alicate cortacables / Cesoie per cavi / Cortador p. Cabos / Coupe-câbles / Knipper voor kabels



Ref.	L[mm]	⊠	EAN
01-510	185	12/72	5907558405361



Ref.	L[mm]	max ø [mm ²]	⊠	EAN
01-513	160	10	6/48	5907558408485
01-514	200	13	6/48	5907558408492
01-515	235	25	6/36	5907558408508



Ref.	L[mm]	⊠	EAN
01-401	400	5/10	5907558449624

Pilot do przeciągania kabli

Cable pulling pilot / Пилот для протягування кабелю / Pilot pentru tras cabluri / Kábelhúzásí pílóta / Telecomando per tiracavo / Pilote pour tirer les câbles / Kabelziehstrumpf / Пилот для протягування кабелю / Pilot pro tažení kabelů / Pilot na tahaanie káblv / Daljinski upravljač za izvlačenje kabela / Kabelio traukimo pultas / Kabelu vilkšanas pilots / Pilot za vleko kablov / Пилот за изтегляне на кабелю / Далжински управљач за извлачење кабла / Πιλότος για έλξη καλωδίων / Kabeltrekker / Guia para puxar cabos / Piloto para arrastar cables / Kaabliõmbur

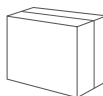

Ref.	L[mm]	⊠	EAN
01-566	300	1/10	5906692026272

Obcinak do drutów i linek stalowych

Cable and steel wire cutter / Abschneider für Draht und Stahlseilen / Кабелорез / Обрізувач до дроту і мпосі / Drótvágó fogó / Cleste taiat cabluri / Kleště na drát a na ocelová lanka / Klešte cvikacie na káble a ocelové laná / Nož za žice in jeklenice / Kandiklės vielai ir plieniniam lynui / Stieplu vai tērauda auklu griezējs / Traadi- ja terasjuhtmelõikur / Резачка за тел и стоманену въжета / Rezač za žice i čelične sajle / Nož za žicu i čeličnu užad / Κόφτης καλωδίων / Alicate para cortar cable trenzado / Troncatrice per cavi e fili in acciaio / Cortador p. Arames e cabos de aço / Cisaille à fils et câbles d'acier / Knipper voor draad en staalkabels



Ref.	L[mm]	⊠	EAN
01-512	190	10/60	5907558410891

Klucz łańcuchowy do rur

Chain pipe wrench / Kettenschlüssel für Rohre / Ключ трубный цепной / Ключ трубний ланцюговий / Csőfogó láncos / Cheie pentru filtrul cu lant / Retězový hasák na trubky / Klúč reťazový na rúry / Verižni ključ za cevi / Grandininis raktas, vamzdžiams / Κέδες σωλήνα ατσίλεγα / Kett-toruvõti / Верижен тръбен ключ / Lančani ključ za cijevi / Ključ za cevi lančani / Αλυσκοάβουρας σωλήνων / Llave de cadena para tubos / Giratubi a catena / Chave de corrente p. tubos / Clef à chaîne pour tubes / Kettings sleutel voor buizen



Ref.	L [mm]	Ra [mm/°]	⊠	EAN
02-444	300	115/4	0/24	5907558481570

Szczypce do rur

Water pump pliers / Rohrzange / Клеци трубные / Кліци трубні / Vízpumpa fogó / clește p/u pompa de apă / Kleště na trubky / Hasák / Cevne klešče / Replės vamzdžiams / Rorzstangas / Veepumba tangid / Клеци Гагза / Klijesta papige / Klesta papragaj / Γκαζοτάναλα / Tenazas para tubos / Pinza regolabile da idraulico / Pinças p. Tubos / Pince pour tubes / Buistang

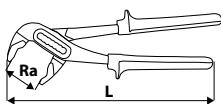

Ref.	L[mm]	Ra[mm]	⊠	EAN
01-202	250	0-36	6/48	5907558434613

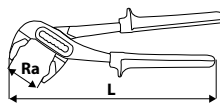

Ref.	L[mm]	Ra[mm]	⊠	EAN
01-200	240	0-31	6/48	5907558434606
01-203	300	0-46	6/24	5907558434620

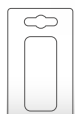
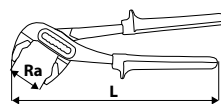

Ref.	L[mm]	Ra[mm]	⊠	EAN
01-204	250	0-42	6/48	5907558412994

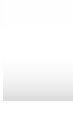
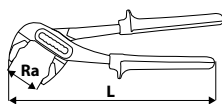

Ref.	L[mm]	Ra[mm]	⊠	EAN
02-435	240	0-52	6/60	5907558464634

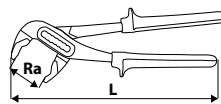

Ref.	L[mm]	Ra[mm]	⊠	EAN
02-412	250	0-38	6/60	5907558463026
02-413	300	0-45	6/48	5907558463033

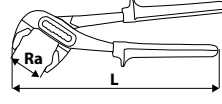

Ref.	L[mm]	Ra[mm]	⊠	EAN
02-401	250	10-45	6/48	5907558462913

Klucz do rur stillson

Stillson pipe wrench / Rohrschlüssel stillson / Ключ трубный stillson / Ключ трубный «Stillson» / Csőfogó „Stillson” / Cheie reglabila pentru tevi / Kleště trubkové Stillson / Ključ na rúry stillson / Ključ za cevi stillson / Raktas vamzdžiams „Stillson” / Cauruļu atslēga / Stillson-toruvõti / Тръбен ключ stillson / Ključ za cijevi stillson / Ključ za cevi stillson / Σωληνοκάβουρας τύπου Stillson / Llave stillson / Giratubi Stillson / Chave p. Tubos stillson / Clef pour tubes stillson / Sleutel voor stillsonbuizen

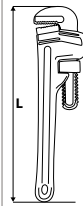

25 years
GUARANTEE AL

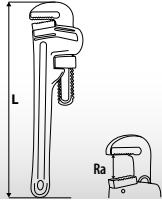

Ref.	L [mm]	Ra [mm/"]	kg [kg]	⊠	EAN
02-415	250	50/1.5	0.62	6/36	5907558463040
02-416	300	70/2.0	0.94	0/24	5907558463057
02-417	350	80/2.0	1.25	0/18	5907558463064
02-418	450	90/2.5	1.79	6/12	5907558463071
02-419	600	100/3.0	2.73	4/8	5907558463088

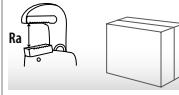

Ref.	L[mm]	Ra ["]	⊠	EAN
02-111	450	1 3/4"	0/24	5907558435856

Obcinak do rur

Tubing cutter / Rohrschneider / Трубкоп / Трубкоп / Csővágó / Dispositiv tăiere țevi / Trubkořez / Rezač rúrok / Rezaclec cevi / Žirkles vamzdžiams / Cauruļgriezējs / Torulõikur / Трубкоп / Rezač cijevi / Sekac za cevi / Κόπτης σωλήνων / Cortador de tubos / Taglia tubi / Cortador p. tubos / Coupe-tube / Buisknipper



25 years
GUARANTEE

TUV Rheinland
CERTIFIED

max
2.5mm

STEEL

Ref.	Ra [mm]	Ra["]	⊠	EAN
02-040	19-83	3/4-3.1/4	10/30	5907558410006

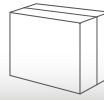

3-22 mm 1/8"-7/8"

CU AL

Ref.	Ra ["]	Ra [mm]	⊠	EAN
02-429	1/8-7/8	3-22	50/200	5907558463514

STEEL

CU AL Ø 3-32 mm Ø 1/8"-1 1/4"



02-042



02-044

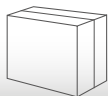

Ref.	info	Ra [mm]	Ra["]	⊠	EAN
02-042	-	3-50	1/8-2.0	0/8	5907558414332
02-044	2 x	-	-	24/288	5907558415735



Ref.	Ra ["]	Ra [mm]	⊠	EAN
02-403	1/8-1.1/4	3-32	12/48	5907558462937

STEEL Ø 12-50 mm Ø 1/2"-2"

CU AL Ø 3-30 mm Ø 1/8"-1 1/8"

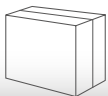

Ref.	Ra ["]	Ra [mm]	⊠	EAN
02-406	1/2 - 2	12-50	0/10	5907558462968



Ref.	Ra ["]	Ra [mm]	⊠	EAN
02-402	1/8-1.1/4	3-32	12/72	5907558462920

Klucz nastawny

Adjustable wrench / Schraubenschlüssel / Ключ разводной / Ключ розівний гаїковий / Csavarkulcs állítható / Cheie reglabilă / Ključ přestavitelný / Nastavitelný ključ / Francoski ključ / Reguliojamas raktas / Bidatslēga / Tellitan vōti / Розводжен гаечен ключ / Podesivni ključ / Francuski ključ / Γαλλικό κλειδί / Llave inglesa / Chiave a rullino / Chave regulável / Clef à ouverture réglable / Verstelbare moersleutel

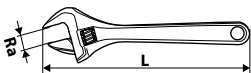

Ref.	Ra [mm]	L [mm]	☒	EAN
03-017	0-30,5	200	0/36	5907558404326



Ref.	L [mm]	Ra [mm]	☒	EAN
03-015	150	0-34	6/96	5907558412208
03-014	200	0-38	6/72	5907558404159
03-016	250	0-50	5/30	5907558412215



Ref.	L [mm]	Ra [mm]	☒	EAN
03-023	155	0-28	6/72	5907558426052
03-024	205	0-32	6/72	5907558426069
03-025	256	0-43	6/36	5907558426076
03-026	306	0-53	6/36	5907558426083



Ref.	L [mm]	Ra [mm]	☒	EAN
03-010	150	0-24	6/120	5907558404111
03-011	200	0-28.6	6/60	5907558404128
03-012	250	0-32.8	6/48	5907558404135
03-013	300	0-38	6/24	5907558404142



Ref.	L [mm]	Ra [mm]	☒	EAN
03-027	150	0-23	6/120	5907558426090
03-028	200	0-28	6/60	5907558426106
03-029	250	0-32	6/48	5907558426113

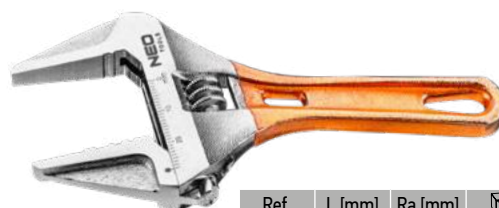

Ref.	L [mm]	Ra [mm]	☒	EAN
03-019	118	0-28	6/72	5907558426014
03-020	139	0-32	6/72	5907558426021
03-021	156	0-43	6/36	5907558426038
03-022	185	0-53	6/36	5907558426045

Nóż z ostrzem łamanym

Snap-off blade knife / Messer m. gebrochener Klinge / Нож с отламывающимся лезвием / Нож з ламаним лезом / Törhető pengés kés / Cuțit lamă demontabilă / Nůž se zalomeným ostrím / Nožik lámací / Nož / Peilis su nulaužiama geležte / Тарешу nazis / Kokkukäiva teraga nuga / Накетен нож / Skalpel / Skalpel / Копіти «snap Off» / Cúter / Taglierino con lama scorrevole / Faca com lâmina curvada / Couteau à lame cassable / Met met gebroken lemmet



Ref.	W [mm]	☒	EAN
63-021	18	12/48	5907558410457



Ref.	W [mm]	☒	EAN
63-011	18	12/72	5907558410440



Ref.	W [mm]	☒	EAN
63-014	18	40/160	5907558484328



Ref.	W [mm]	☒	EAN
63-713	18	20/160	5906692018727

Nóż z ostrzem łamanym

Snap-off blade knife / Messer m. gebrochener Klinge / Нож с отламывающимся лезвием / Ніж з ламаним лезом / Törhető pengés kés / Čužit lamä demontabilä / Nůž se zalomeným ostřím / Nožik lámací / Nož / Peilis su nulažiama geležte / Tapešu nazis / Kokkukäiva teraga nuga / Макетен нож / Skalpel / Skalpel / Κοπίδι «snap Off» / Cúter / Taglierino con lama scorrevole / Faca com lâmina curvada / Couteau à lame cassable / Met met gebroken lemmet



Ref.	W [mm]	⊠	EAN
63-012	25	12/72	5907558443530



Ref.	W [mm]	⊠	EAN
63-050	18	12/72	5907558420760



Ref.	W [mm]	⊠	EAN
63-060	18	12/72	5907558420777



Ref.	W [mm]	⊠	EAN
63-013	9	48/576	5907558484311

Nóż z ostrzem trapezowym

Knife with utility blade / Messer mit Trapezklinge / Нож с трапецевидным лезвием / Ніж з трапецевидним вістрям / Trapézpengés összecskukható kés / Cutter cu tăiş trapezoidal / Nůž s trapézovým ostřím / Nož s trapézovou čepelou / Nož s trapeznim rezilom / Peilis su trapecine geležte / Nazis ar trapecveida asmeni / Trapetsteraga nuga / Нож с трапецевидно острие / Nož s trapezastom ostricom / Nož sa trapezastom ostricom / Μαχαίρι με τραπεζοειδή ακμή / Cúter con hoja trapezoidal / Taglierino a lama fissa / Faca com Lâminas de trapézio / Couteau à lame trapézoïdale / Trapezium mes



Ref.	⊠	EAN
63-700	6/48	5907558483932



Ref.	⊠	EAN
63-704	10/80	5907558472318



Ref.	⊠	EAN
63-708	8/80	5907558477153



Ref.	W [mm]	⊠	EAN
63-702	18	0/80	5907558400212



Ref.	⊠	EAN
63-707	10/80	5907558472356



Ref.	⊠	EAN
63-705	12/96	5907558472295



Ref.	⊠	EAN
63-706	12/48	5907558472325

Ostrza łamane

Snap off blades / Klengen, abbrechbar / Лезвия сменные отламывающиеся / Леза змінні, що обламуються / Törhető penge / Lame cutter / Odlamovací čepele / Odlamovacie čepele / Lomljiva rezila / Laužomi peiliukai / Maināmie nolaužamie asmeņi / Vaibanoa terad / Отчупващи се остриета / Lomljene oštrice / Lomljene oštrice / Ανοσώμενες λεπίδες / Hojas segmentadas / Ricambio lame scorrevoli / Lâminas curvadas / Lames coupées / Gebogen bladen



Ref.	W [mm]	⊠	EAN
64-220	9	10/300	5907558400250



Ref.	W [mm]	⊠	EAN
64-020	18	10/300	5907558400236

Ostrza trapezowe

Knife blades / Trapezklengen / Лезвия трапециевидные / Леза ножови / Törhető penge / Cutit lamă / Lichobežnikové ostří / Ostrie lichobežníkové / Nadomestna rezila / Keičiamos geležtės / Naža asmeņi / Noaterad / Острие резервно / Nožiči za skalpel / Nožici za skalpel / Ανταλλακτικές λεπίδες / Hojas trapezoidales / Ricambio lame fisse / Lâminasde trapézio / Tranchants trapézoidaux / Trapezium mesbladen

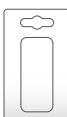

Ref.	⊠	EAN
64-015	10/240	5907558443578



Ref.	L [mm]	⊠	EAN
64-420	52	10/300	5907558400274

Ostrza hakowe

Hook blades / Hackenklengen / Лезвия-крючки / Леза гакові / Törhető penge / Lame seceră pentru cutter / Hákové čepele / Hákové čepele / Kļukasta rezila / Geležtē / Asmeņi-āķi / Konksterad / Остриета за нукки / Kukaste oštrice / Kukasti noževi / Κοιλιδι τάνητα / Hoja de gancho / Ricambio lame ad uncino / Lâminas de anzol / Lames à crochets / Haakbladen



Ref.	⊠	EAN
64-620	10/300	5907558400298

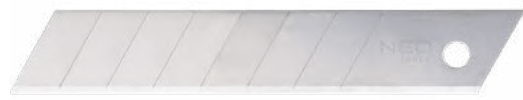

Ref.	W [mm]	⊠	EAN
64-010	18	10/300	5907558400229



Ref.	L [mm]	⊠	EAN
64-013	18	10/120	5907558443554
64-014	25	10/120	5907558443561

Nóż uniwersalny

Knife / Universalmesser / Нож универсальный / Нож / Trapézpengés összecusukható kés / Cutit / Univerzální nůž / Nóż uniweryalny / Nož / Universālus peilis / Nazis / Nuga / Ножыче / Džepni nožič / Nož / Μαχαίρι γενικής χρήσης / Cuchillo universal / Taglierino a lama fissa / Faca universal / Couteau universel / Universele mes

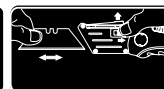
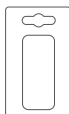

Ref.	⊠	EAN
63-710	6/48	5907558420791

Skrobak

Scraper / Шерхебель / Ráztaoare / Kaparó / Raschietto / Grattoir / Kratzer / Скребок / Škrabák / Strugalička / Gremžtukas / Skrapis / Strgalo / Шабар / Strugac / Ξύστρα / Krabber / Rascador / Rasqueta / Kaabits



Ref.	⊠	EAN
63-710	6/48	5907558420791

Nożyczki

Scissors / Schere / Ножницы / Ножуци / Olló / Foarfeca / Nůžky / Nožnice / Škarje / Žirkles / Šķēres / Käärid / Ножуци / Škarice / Makaze / Ψαλίδι / Tijeras / forbice da elettricista / Tesoura / Ciseaux / Schaar



Ref.	L [mm]	⊠	EAN
64-001	230	12/72	5907558485462

NARZĘDZIA SPECJALISTYCZNE

specialized tools спеціалізовані інструменти



Zestaw kluczy nasadowych do filtra oleju

Car type oil filter wrench set / Steckschlüsselsatz für Ölfilter / Набор торцовых ключей к масляному фильтру / Набор накидных ключей до оливного фильтру / Dugókulcs-készlet olajsűrűhöz / Set de chei tubulare pentru filtru de ulei / Sada miskovitých klíčů na olejové filtry / Súpřava nástavcových klíčův na olejový filter / Set nasadnih ključev za oljni filter / Galvucių rinkinys tepalo filtriui / Eļļas filtra mucīnatslēgu komplekts / Ólīfīltri padrunvõtmete komplekt / Комплект гаечни ключове за масления филтър / Garnitura nasadnih ključeva za filter ulja / Garnitura ključeva natikača za filtere za ulje / Σετ μπουλονόκλειδα για φίλτρο λαδιού / Juego de llaves de vaso para filtro de aceite / Completo di chiavi a bussola per il filtro dell'olio / Jogo de chaves tubulares para filtro de óleo / Jeu de clés à douille pour filtre à huile / Set van dopseutels voor oliefilter

x30



x16



Ref.	Ø mm	N	Car
66/6	66	6	Fiat Punto 1.2; Renault Clio 1.2, Rapid, Twingo
65/14	65	14	Daihatsu; Toyota; Nissan; Fiat; Camry
65/67	65-67	14	Daihatsu; Toyota; Mazda; Mitsubishi
68/14	68	14	Mazda; Ford; Subaru; Toyota
73/14	73	14	Toyota; Lexus
74/15	74	15	Audi; Rover; Chrysler; Lexus; GM
74/76	74-76	15	Ford; Opel; VW; Audi; Mercedes; GM
75/77	75-77	15	VW; Audi; Isuzu; Mercedes; GM; Chrysler
76/12	76	12	Fiat; Mercedes; Renault
76/14	76	14	VW; Porsche; Mercedes; BMW; Audi; Opel; Buick
76/30	76	30	Ford; VW; Renault; Peugeot
76/8	76	8	Fiat; Lancia
78/15	78	15	Nissan; Ford; Toyota
80/15	80	15	Nissan; Honda; Opel; Mazda; Iveco

Ref.	Ra[mm]	⊠	EAN
11-242	66-108	1/2	5907558435955

Ref.	Ø mm	N	Car
80/82	80	15	Subaru; Toyota; Honda; Nissan; Iveco; Hyundai; Mazda
86/16	86	16	Volvo
86/18	86	18	VW Golf; Audi A6 TDI; Peugeot; Citroen
90/15	90	15	Honda; Mitsubishi; Isuzu; Mazda
92/10	92	10	Fiat
93/15	93	15	Mazda; Volvo; Mitsubishi; Nissan; Honda
93/36	93	36	Ford; Audi
93/45	93	45	VW; Audi TDI
95/15	95	15	Toyota; Alfa Romeo; Ford
96/18	96	18	Audi A4; A6 TDI; VW Passat TDI; Renault Laguna
100/15	100	15	Isuzu; Mitsubishi; Buick; Hyundai; Iveco; Daewoo; Renault
106/15	106	15	Fiat Ducato
108/15	108	15	Volvo
108/18	108	18	Renault Espace; Laguna; Safrane; Traffic

Ref.	Ra[mm]	⊠	EAN
11-243	65-100	1/10	5907558435962

Nasadka do filtra oleju

Car type oil filter wrench / Ölfilterkappen / Съемник масляного фильтра "чашка" / Знімач масляного фильтра "чашка" / Csésze olajsűrű lehéző / Cupă filtru de ulei / Stahovák olejového filtru / Ključ na olejový filter / Ključ za oljni filter / Raktas tepalo filtriui / Atslėga eļļas filtram / Ólīfīltri vōti / Водуца шина за ораза / Ključ za uljni filter / Ključ za uljani filter / Кλειδί φίλτρου λαδιού / Llave para filtro de aceite / Chiave per il filtro dell'olio / Chave p. filtros de óleo / Clef à filtre d'huile / Seutel voor oliefilter



3/8"

Ref.	Ø mm	N	⊠	EAN
11-360	76	12	10/60	5907558445299
11-361	65	14	10/60	5907558445305
11-362	67	14	10/60	5907558445312
11-363	73	14	10/60	5907558445329
11-364	76	14	10/60	5907558445336
11-365	74	15	10/60	5907558445343
11-366	78	15	10/60	5907558445350
11-367	80	15	10/60	5907558445367
11-368	90	15	10/60	5907558445374
11-369	95	15	10/60	5907558445381
11-370	108	15	10/60	5907558445398
11-371	86	16	10/60	5907558445404
11-372	86	18	10/60	5907558445411
11-373	96	18	10/60	5907558445428

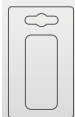

Klucz do filtra oleju

Oil filter wrench / Schlüssel für Ölfilter / Съемник масляных фильтров / Ключ для оливних фильтрив / Olajsűrű teszedő / Cheie pentru filtre de ulei / Ključ na olejový filter / Ključ na olejový filter / Ključ za oljni filter / Raktas tepalo filtriui / Eļļas filtra atslēga / Ólīfīltri vōti / Ключ за маслен филтър / Ključ za filtre za ulje / Ključ za filter za ulje / Кλειδί αφάρσεως φίλτρου λαδιού / Llave para filtros de aceite / Chiave per filtro olio / Chave para filtros de óleo / Cle filtre a huile / Filtersleutel

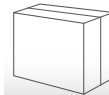

Ref.	Ra[mm]	⊠	EAN
11-237	43-102	1/40	5907558437355

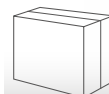

Ref.	Ra[mm]	⊠	EAN
11-239	64-100	1/40	5907558435924

Klucz do filtra oleju

Oil filter wrench / Schlüssel für Ölfilter / Съёмник масляных фильтров / Ключ для масляных фильтров / Olajszűrő leszedő / Cheie pentru filtre de ulei / Klíč na olejový filtr / Ključ na olejový filter / Kļuvc za oljni filter / Raktas tepalo filtrui / Eļļas filtru atslēga / Ölfiltrivõtli / Ключ за маслен филтър / Kļuvc za filtre za ulje / Kļuvc za filter za ulje / Κλειδί αφαίρεσης φίλτρου λαδιού / Llave para filtros de aceite / Chiave per filtro olio / Chave para filtros de óleo / Cle filtre a huile / Filterseutel



Ref.	Ra[mm]	⊠	EAN
11-238	64-120	1/40	5907558437362



Ref.	Ra[mm]	⊠	EAN
11-231	73 - 85	6/36	5907558416657



Ref.	Ra[mm]	⊠	EAN
11-381	60 - 115	5/20	5907558445459

60-115 mm



1/2"

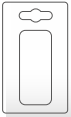

Ref.	Ra[mm]	⊠	EAN
11-380	80 - 115	1/20	5907558445442

80-115 mm

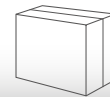

Klucze do spustu oleju

Oil drainer set / Ölablassschlüssel / Ключи для слива масла / Ключи для зливання оливи / Olajleeresztő kulcs készlet / Cheie pentru dop de scurgerea uleiului / Klíče na vypuštění oleje / Sada klíčův na vypuštění oleje / Vijaki za spruščanje olja / Raktai alyvos išleidimui / Eļļas nolaišanas atslēgas / Ölilorgji vôtmed / Ключове за източване на масло / Kļuvcēvi za ispuštanje ulja / Kļuvcēvi za ispuštanje ulja / Σετ αποστράγγισης λαδιού / Llaves para evacuación de aceite / Inserti per tappo olio / Chaves para evacuação de óleo / Clés pour la vidange d'huile / Sleutels voor oliedreinage



Ref.	Ra[mm]	⊠	EAN
11-382	60 - 160	6/24	5907558445466

60-160 mm

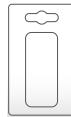

CrV steel

3/8"

x18



Ref.	Ra[mm]	⊠	EAN
11-240	63.5 - 116	6/36	5907558435931

20°



Ref.	Ra[mm]	⊠	EAN
11-241	63.5 - 116	5/30	5907558435931

30°
60°
90°



Zastosowanie / Application / Применение:

Hex 8 mm: BMW, Ford, GM

Hex 9 mm: GM

Hex 10 mm: Ford

Hex 12 mm: Fiat, Lancia, Peugeot

Hex 14 mm: Lancia, Mercedes

Hex 17 mm: Audi, VW, BMW, Austin

Square 7, 8 mm Citroen, Peugeot, Renault, Talbot, Volvo

Square 11 mm: Ford

Square 13.1 mm: Nissan, Subaru

Square 3/8": Honda, Mazda, Renault, Saab, Volvo

Square (5/16"), 10 mm Female, Square: 10 mm: do skrzyń biegów i mechanizmów dyferencyjnych różnych marek aut np. / for gearboxes and differential mechanisms of various makes / для коробки передач и дифференциала автомобилей разных марок: BMW, Ford, Renault, Toyota

Triangular: 10 mm Renault

M16 Spline (Tamp-proof): Audi A4 i A6



Ref.	⊠	EAN
11-235	0/10	5907558417098

Końcówka wkrętakowa do korków oleju

Special bit for oil drain plug / Spezial Bit für Ölablassschraube / Бита специальная для сливной пробки / масляного под / Бита для сливной пробки / Bit az olajdugókhöz / Bit special pentru dopul de scurgere a uleiului / Speciální bit pro vypouštěcí zátku oleje / Špeciálny bit pre vypúšťaciu zátku oleja / Poseben bit za zamašek za izpust olja / Specialus antgalis alyvos išleidimo kamščiu / Įrašs bit eļļas iztukšošanas aizbāžnei / Spetsiaalne ots õli väljalaskekruvi jaoks / Ключ за маслени тапи / Ключ за черпове за уље / Ключ за чепове за уље / Кλειδί για βύσματα λαδιού / Llave especial tapón de aceite / Chiave speciale per tappi olio / Chave especial para óleo / Clé à bouchon d'huile spéciale / Speciale olieplugsleutel



1/4"



Audi / SEAT / Škoda / VW:
model year 2013 with 1.2 · 1.4 · 1.8 · 2.0 l TFSI petrol engines
Audi: A1, A3, A4, A5, Q5
VW: Golf 7
SEAT: Leon, etc. with 1.6 and 2.0 l diesel engines



Ref.	☒	EAN
11-383	20/100	5907558452266

Zestaw do misek oleju

Oil change tool kit / Ölwechsel-Werkzeugsatz / Набор инструментов для замены масла / Набор інструментів для заміни масла / Különleges szerszámkészlet olajcseréhez / Trusă de scule specială pentru schimbul de ulei / Speciální sada nářadí pro výměnu oleje / Špeciálny sada náradia na výmenu oleja / Orodje komplet posebnih za menjavo olja / Įrankių rinkinys specialus alyvos keitimui / Įrašs instrumentu komplekts eļļas maiņai / Тоористакомплект спэсiалне õlivahetuseks / Комплект инструменти за смяна на масло / Komplet alata poseban za zamjenu ulja / Комплект алата спецiални за замену уље / Ειδικό κιτ εργαλείων για αλλαγή λαδιού / Kit de herramientas especial para cambio de aceite / Kit attrezzi speciali per cambio olio / Kit de ferramentas especial para troca de óleo / Kit d'outils spécial pour le changement d'huile



5
ELEMENTS

1/4"

3/8"



Audi / SEAT / Škoda / VW:
model year 2013 with 1.2 · 1.4 · 1.8 · 2.0 l TFSI petrol engines
Audi: A1, A3, A4, A5, Q5
VW: Golf 7
SEAT: Leon, etc. with 1.6 and 2.0 l diesel engines



OEM: Connect 31775 Peugeot/Citroen (OEM 9801444780 Plug) and Ford (OEM 18711598 plug) Connect 31776 Ford (OEM 1830727 plug) Connect 31774 BMW (OEM 11137605018 plug) Connect 31771 VAG (OEM 06L 103 801 sump and cam cover plug)

Ref.	☒	EAN
11-384	5/20	5907558452273

Odciągarka do oleju

Oil suction gun / Ölabszieher / Отсосное устройство для масла / Оливовідсмоктувач / Olajleszívó / Trägätör de ulei / Odsávačka oleje (ruční) / Odsávačka na olej / Črpalka za olje / Alyvos siurblys / Eļļas atvilcējs / Ölisüstal / Засмукваща маслена помпа / Sisaljka za ulje / Pupa za ispušavanje ulja / Αναρροφητήρας λαδιού / Dispositivo de extracción de aceite / Pistola di aspirazione olio / Máquina de remover óleo / Vidangeur d'huile / Olieafzuiger



METAL

280
mm

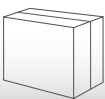

Ref.	[ml]	Ø [mm]	L [mm]	☒	EAN
11-510	500	56,4	280	0/20	5907558415346
11-511	1000	62,5	400	0/10	5907558415353

Mobilna zlewarka do oleju, grawitacyjna

Mobile oil siphon, gravity / Mobilier Ölsiphon, Schwerkraft / Передвижной масляный сифон, гравитационный / Мобільний масляний сифон, гравіт / Mobil olajszifon, gravitáció / Sifon mobil de ulei, gravitațional / Mobilni olejovj sifon, gravitace / Mobilný olejový sifón, gravitačný / Mobilni sifon za olje, gravitacijski / Mobilus alyvos sifonas, gravitacija / Mobilis eļļas sifons, gravitācija / Mobilne õlisifoon, gravitatsioon / Мобилен маслен сифон, гравитачен / Mobilni sifon za ulje, gravitacijski / Мобилни сифон за уље, гравитација / Κινητό σιφόν λαδιού, βαρύτητας / Sifón de aceite móvil, gravedad / Sifone olio mobile, gravità / Sifón de óleo móvel, gravidade / Siphon à huile mobile, gravité / Mobbiele oliesifon, zwaartekracht



TANK DISCHARGE
PRESSURE
0,1-1 BAR

70L
TANK
CAPACITY

18
Kg

Ref.	☒	EAN
10-810	0/1	5907558499841

Mobilna zlewarko-wysysarka do oleju pneumatyczna ze zbiornikiem kontrolnym

Mobile pneumatic oil sink and extractor with a control tank / Mobile pneumatische Ölspüle und -absaugung mit Kontrolltank / Передвижной пневматический маслосорбник и экстрактор с контрольным баком / Мобільний пневматичний маслозіймоник і екстрактор з резервуаром управління / Mobil pneumatikus olajmosó és elszívó vezérlőtartállyal / Chiuvetă pneumatică mobilă pentru ulei și extractor cu rezervor de control / Mobilni pneumatický olejový džez a odsávač s kontrolní nádrží / Mobilný pneumatický olejový džez a odsávač s kontrolnou nádržou / Mobilni pnevmatski zbiralnik in ekstraktor olja s krmilnim rezervoarjem / Mobilni pnevmatinė alyvos kriauklė ir siurblys su valdymo baku / Mobilā pnevmatiskā eļļas izlietne un nosūcējs ar vadības tvertni / Mobilne pnevmatiline õlivalamu ja väljatõmbeseade koos juhtpaagiga / Мобилен пневматичен маслен мивна и екстрактор с резервоар за управление / Mobilni pnevmatski sudoper i ekstraktor ulja s kontrolnim spremnikom / Мобилни пневматски уљни судопер и извлачи са контролним резервоаром / Κινητός pnevmatikós νεροχύτης λαδιού και εξακλόα με δεξαμενή ελέγχου / Fregadero y extractor de aceite neumático móvil con tanque de control / Dissipatore ed estrattore d'olio pneumatico mobile con serbatoio di controllo / Dissipador e extractor de óleo pneumático móvel com tanque de controle / Puits et extracteur d'huile pneumatiques mobiles avec réservoir de contrôle / Mobbiele pneumatische olie-afzuigend en -afzuiger met controletank



10L
CONTROL
TANK

TANK DISCHARGE
PRESSURE
1-3 BAR

70L
TANK
CAPACITY

6-8 BAR
WORKING
PRESSURE

25
Kg

Ref.	☒	EAN
10-811	0/1	5907558499858

Wanna do oleju

Oil drain bucket / Ölwanne / Ванночка для масла / Ванна оливна / Olajkád / Baie de ulei / Vana na olej / Vaňa na olej / Posoda za olje / Vonele teralui / Vanniņa eļļai / Ölwanne / Vana za maslo / Posuda za ulje / Kada za ulje / Λεκάνη αποστράγγισης λαδιού / Bandeja para aceite / Contenitore olio / Bandeja para troca de óleo / Bac à huile



7L
PLASTIC

Ref.	☒	EAN
11-550	0/10	5907558415360

Miska do zlewania oleju, płynu chłodniczego

Bowl for pouring oil, coolant / Schüssel zum Umfüllen von Öl und Kühlmittel / Чаша для слива масла, охлаждающей жидкости / Чаша для зливання масла, охолоджуючої рідини / Tál olaj, hűtőfolyadék dekantálásához / Bol pentru decantarea uleiului, lichidului de răcire / Nádoba na stáčení oleje, chladicí kapaliny / Miska na dekantáciu oleja, chladiacej kvapaliny / Miska na dekantáciu oleja, chladiacej kvapaliny / Dubuo alyvai, aušinimo skysčiai nupilti / Βλoda ελλας, dzesēšanas šķidrums dekantēšanai / Kauss ūli, jahutusedeliku dekanteerimiseks / Купа за декантиране на масло, охлаждаща течност / Posuda za pretakanje ulja, rashladne tekućine / Посуда за преливање уља, расхладне течности / Μπολ για μετάγγιση λαδιού, ψυκτικό / Recipiente para decantar aceite, refrigerante / Ciotola per travaso olio, refrigerante / Recipiente para decantar óleo, líquido de arrefecimento / Bol pour décanter l'huile, le liquide de refroidissement / Kom voor het decanteren van olie, koelvloeistof



PE
16L

Ref.	☒	EAN
10-800	1/6	5907558495799

Miska do zlewania oleju

Oil drain pan / Ölauffangwanne / Поддон для слива масла / Піддон для зливу масла / Olajleeresztő edény / Tava de scurgere a uleiului / Вурпушечі nádoba na olej / Nádoba na vupúšťanie oleja / Posoda za izpust olja / Alyvos nutekėjimo indas / Ελλας notekas panna / Öl i tühjenduspann / Съд за източване на масло / Posuda za ispuštanje ulja / Посуда за испуштање уља / Ταψί αποστράγγισης λαδιού / Ταψί αποστράγγισης λαδιού / Vaschetta di scarico dell'olio / Bandeja de drenagem de óleo / Bac de vidange d'huile / Olie opvangbak



PE
12L

Ref.	☒	EAN
10-801	1/4	5907558495805

Nalewak warsztatowy, konewka

Workshop pouter, watering can / Werkstattaussgießer, Gießkanne / Наливная мастерская, лейка / Майстерня наливна, літка / Műhelyöntő, öntözőkanna / Atelier de turnare, adapatoare / Dilenský nalievač, konev / Dielenský nalievač, kanva / Delavniški točilnik, zalivalka / Dirbtuvių piltuvas, laistytuvas / Darbības lejšs, lejkanna / Töökoja valaja, kastekann / Работилница за наливане, лейка / Radionička sipalica, kanta za zaljevanje / Радионички сипач, канта за заливање / Χητής συνεργείου, ποτιστήρι / Vertedor de taller, regadera / Versatore da officina, annaffiattoio / Despejador de oficina, regador / Verseur d'atelier, arrosoir / Werkplaatschenker, gieter



PE

Ref.	V [l]	☒	EAN
10-802	1	1/24	5907558495812
10-803	3	1/20	5907558495829
10-804	5	1/16	5907558495836

Strzykawka do płynów eksploatacyjnych

Syringe for operating fluids / Spritze für Betriebsflüssigkeiten / Шприц для рабочих жидкостей / Шприц для операційних рідин / Fecskendő működési folyadékokhoz / Seringă pentru fluide de operare / Sřĩkačka na provozní kapaliny / Striekačka na prevádzkové kvapaliny / Brizga za operativne tekoćine / Švirkštas darbiniam skysčiams / Šjirce darbības šķidrumiem / Süstal töövedelike jaoks / Спринцовка за работни течности / Šprica za radne tekućine / Шприц за оперативне течности / Σύριγγα για κυρά λειτουργίας / Jeringa para fluidos operativos / Siringa per fluidi operativi / Seringa para fluidos operacionais / Seringue pour fluides opératoires / Smit voor bedrijfsvloeistoffen



PP
PVC
HOSE
30cm
+
30cm

Ref.	V [ml]	☒	EAN
10-805	200	1/25	5907558495843
10-806	500	1/20	5907558495850
10-807	1500	1/10	5907558495867

Kanister na benzynę

Can for petrol / Benzinbehälter / Канистра для бензина / Канистра для бензину / Üzematanyagkanna, műanyag / Bidon de benzín / Kanistr na benzin / Kanistra na benzin / Kanister za bencin / Bakas benziniui / Benzina kanna / Bensiinkanister / Бидон за бензин / Kanister za benzin / Kanta za benzin / Κάνιστρο Βενζίνης / Bidón para gasolina / Tanica per la benzina / Tanque para gasolina / Jerricane à essence / Jerrycan voor benzin



HDPE
PP
LDPE

Ref.	V [l]	☒	EAN
11-560	10	0/50	5907558436402
11-561	20	0/30	5907558436419

Myjka do części samochodowych

Car parts washer / Μύλκα αυτομαρτιν / Spälatör de piese auto / Autóalkatrész mosó / Lavaggio ricambi auto / Laveuse de pièces automobiles / Autoteile-Waschanlage / Мойка автомобильных деталей / Μύλκα autodílů / Umývačka automobilových súčiastok / Peráč auto dijelova / Automobilių dalių plovykla / Auto detaļu mazgātājs / Pralnik avtomobilskih delov / Миялна машина за автомобилни части / Перач ауто делова / Πλυντήριο ανταλλακτικών αυτοκινήτων / Auto-onderdelen wasmachine / Máquina de lavar peças para automóveis / Lavaparabrisas / Autoosade pesumasin



Ref.	☒	EAN
10-812	1/1	5906692019397



Ref.	☒	EAN
10-813	1/1	5906692019403

Lejek

Funnel / Trichter / Воронка / Воронка / Tölcsér, flexibilis, szűrővel / Pálnie / Nálevka / Lievik / Lijak / Piltuvēlis / Piltuve / Lehter / Фуння / Lijevak / Levak / Χωνί / Embudo / Imbuto / Funil / Entonnoir / Trechter



1,2 L HDPE LDPE

Ref.	☒	Ø ₁ [mm]	Ø ₂ [mm]	☒	EAN
11-555-1		45	160	0/50	5907558474558



Ø125MM DEPTH 250MM HANDLE INCLUDED

Ref.	☒	EAN
10-808	4/8	5907558499810



FOLDABLE DIMENSIONS: 10.5 X 14.5 CM SILICONE MATERIALS

Ref.	☒	EAN
10-809	0/50	5907558499827



PP Ø 13 mm Ø 160 mm 90g

Ref.	☒	Ø ₁ [mm]	Ø ₂ [mm]	☒	EAN
11-552		13	160	0/50	5907558435887



PE 2,9 l Ø 195 mm Ø 20 mm

Ref.	☒	EAN
11-551	0/72	5907558439977



PP

Ref.	L [mm]	Ø ₁ [mm]	Ø ₂ [mm]	☒	EAN
11-556	450	10	115	0/48	5906692024230
11-557	282	10	70	0/300	5906692024247



PP Ø 160 mm Ø 13 mm height 390 mm

Ref.	Ø ₁ [mm]	Ø ₂ [mm]	☒	EAN
11-553	13	160	0/40	5907558435894

Smarownica dźwigniowa

Lever-operated grease gun / Schmierspitzze mit Hebel / Шприц рычажно-плунжерный / Шприц ваژیельно-плунжерный / Karos zsírzó / Gresor cu prghie / Páková maznice / Páková mazica / Ročná mazalka / Rankinis tepalo presas / Leel[ot]ajš ar sviru / Kangiga määrimisseade / Ръчна масло̀нка / Mazalica ručna / Mazalica na pumpu / Γρασαδὸρος με μοχλό / Engrasadora de palanca / Pistola per grasso / Pistola de lubrificação / Graisseur à levier

400 cm³ 10000 Psi 8x300 mm



Ref.	☒	EAN
11-500	0/10	5907558415278



380x125x70mm
CAPACITY 500cm³
WORKING PRESSURE 400bar
HOSE TIP 11x300mm
EFFICIENCY 1.2cm³

Ref.	☒	EAN
11-501	0/10	5907558426465

Pompa do oleju

Oil pump / Ölpumpe / Масляный насос / Pompa do oleju / Olajpumpa / Potpā de ulei / Čerpadlo na olej / Čerpadlo na olej / Črpalka za olje / Alyvos pompa / Eļļas sūkņis / Ölirupr / Маслена помпа / Uļņa pumpa / Pumpa za ulje / Αντλία λαδιού / Bomba para aceite / Pompa dell'olio / Bomba de óleo / Pompe à huile



TELESCOPIC
capacity 18L/min
for barrels 60/200/220L
800x90x90mm
PVC/NBR

Ref.	☒	EAN
11-565	0/10	5907558426496

Zestaw do wymiany płynu hamulcowego i odpowietrzania hamulców

Brake fluid change and brake bleeding kit / Bremsflüssigkeitswechsel und Bremsenentlüftungsset / Замена тормозной жидкости и комплект для продувки тормозов / Комплект для заміни гальміної рідини та прокачування гальм / Fékfolyadékcsere és fékkivezető készlet / Kit de schimbare a lichidului de frână și kit de săngerare a frânelor / Sada pro výměnu brzdové kapaliny a odvzdušnění brzd / Súprava na výmenu brzdovej kvapaliny a odvzdušnenie brzd / Komplet za menjavo zavorne tekočine in odzračevanje zavor / Stabdžiu skyščio keitimo ir stabdžiu nuleidimo rinkinys / Bremžu šķidrums nomainas un bremžu atskurbšanas komplekts / Pidurivedeliku vahetamise ja pidurite tühjendamise komplekt / Комплект за смяна на спирачната течност и обезвъздушаване на спирачките / Komplet za zamjenu kočione tekučine i odzračivanje kočnica / Комплект за замену кочіонне течности и за одзрачивање кочница / Kit αλλαγής υγρού φρένων και εξαέρωσης φρένων / Kit de cambio de líquido de frenos y purga de frenos / Kit per la sostituzione del liquido dei freni e lo spurgo dei freni / Mudança do líquido dos travões e kit de purga dos travões / Changement du liquide de frein et kit de purge des freins / Remvloeistof verversen en remontluchtingsset



0,75L
6-8 bar
1/4"
180L/min

Ref.	☒	EAN
11-268	0/6	5907558404098

Wężyk do smarownic

Hose for grease gun / Schlauch für Schmiergeräte / Шланг смазочный / Шланг до дозатора oleju / Zsírzó cső / Furturpentru pistol de gresare/ungere / Hadička pro mazničky / Hadička do maznic / Cev za mazalnike / Žarnelē terpalinēms / Caurulīte eļļas kannīnai / Ölirūstolivoolik / Маркуч за масло̀нка / Crijevo za mazalice / Crevo za podmazivanje / Εύκαμπτος σωλήνας λίπανσης / Manguera para engrasadoras / Tubo in Nylon / Mangueira para lubrificadores / Flexible de graisseur / Slang voor smeetapparaten



Ref.	L [mm]	☒	EAN
11-532	11x300	0/100	5907558415308



length 36mm ø15cm M10x1 ø11mm

Ref.	L [mm]	☒	EAN
11-502	11x150	100/200	5907558426472

Końcówka smarownicy 4 szczękowa

Lubricating nipple 4 jaw / Schmiernippel 4 Backe / Смазочный ниппель 4 щęki / Мазильний нпелъ 4 зубки / Кендітмбó 4 állkarpos / Niplu de lubrifriere 4 fáici / Mazací vsuvka 4 čelisti / Mazacia vsuvka 4 čeluste / Mazalna bradavica 4 čeljust / Tepimo nipelis 4 žandikaulis / Ελδοσανα sprausla 4 spailas / Määrdenippel 4 löualuu / Смазачч нипел 4 чэлюст / Vrh pištoľja za podmazivanje s 4 čeljusti / 4-челюстна връх пушторъа за подмазиванье / Θηλή λίπανσης 4 σταγόνα / Engrasador 4 mordazas / Nipplo di lubrificazione 4 ganasce / Bocal de lubrificação 4 maxilas / Graisseur 4 mâchoires / Smeernippel 4 kaken



25pcs

Ref.	☒	EAN
11-503	250/500	5907558426489

Tester płynu hamulcowego diodowy

LED brake fluid tester / LED-Bremsflüssigkeitstester / Светодиодный тестер тормозной жидкости / Светлодіодний тестер гальмівної рідини / LED-es fékfolyadék teszter / Tester de lichid de frana cu LED / LED tester brzdové kapaliny / LED tester brzdovej kvapaliny / LED tester zavorne tekočine / LED stabdžiu skysčio testeris / LED bremžu šķidruma testeris / LED pidurivedeliku tester / LED тестер за спирачна течност / LED tester kočione tekućine / ЛЕД тестер нощионе течности / Докираστής υγρών φρένων LED / Probador de líquido de frenos LED / Tester liquido freni a LED / Testador de fluido de freio LED / Testeur de liquide de frein à LED / LED-remvloestoftester

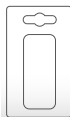

Ref.	☒	EAN
11-269	0/100	5907558473926

Elektroniczny tester płynu hamulcowego

Electronic brake fluid tester / Elektronischer Bremsflüssigkeitsprüfer / Электронный тестер тормозной жидкости / Електронний тестер гальмівної рідини / Elektronikus fékfolyadék-tesztelő / Tester electronic pentru lichidul de frână / Elektronický tester brzdové kapaliny / Elektronický tester brzdovej kvapaliny / Elektroniski tester zavorne tekočine / Elektroninis stabdžiu skysčio testeris / Elektroniskais bremžu šķidruma testeris / Elektrooniline pidurivedeliku tester / Електронен тестер за спирачна течност / Elektronički tester kočione tekućine / Електронски тестер нощионе течности / Ηλεκτρονικός ηλεκτρικής υγρών φρένων / Comprobador electrónico del líquido de frenos / Tester elettronico del liquido dei freni / Verificador eletrônico do fluido dos travões / Testeur électronique de liquide de frein / Elektronische remvloestof tester



COLOR LCD	% WATER	3V BATTERY
DOT3	DOT4	DOT5.1
EVN4	EVN6	🔊

Ref.	☒	EAN
11-273	1/20	5906692015467

Spryskiwacz ciśnieniowy warsztatowy

Workshop pressure washer / Werkstatt-Hochdruckreiniger / Мойка высокого давления для мастерских / Мойка високого тиску для майстерні / Műhelyi magasnyomású mosó / Maşină de spălat cu presiune de atelier / Dílenská tlaková myčka / Dielenská tlaková umývačka / Tlačni čistilnik za delavnice / Dirbtuvių slėginis plovimo įrenginys / Darbnīcas spiediena mazgātājs / Töökoja survepesur / Работилница за миене под налягане / Radionički visokotlačni perać / Радионична машина за прање под притиском / Πλυτήριο πίεσης συνεργείου / Hidroimpiadora de taller / Idropulitrice da officina / Máquina de lavar a pressão para oficina / Nettoyeur haute pression d'atelier / Werkplaats hogedrukreiniger



1,5L

PP + PE

Ref.	☒	EAN
10-815	0/20	5907558473933

Uniwersalny klucz do drążków kierowniczych

Universal tie rod spanner / Universalschlüssel für Zugstangen / Универсальный гаечный ключ / Універсальний ключ для стяжних шпильок / Univerzális nyakkulcskulcs / Cheie universală pentru tiranți / Univerzální klíč na spojovací tyče / Univerzálny klúč na spojovacie tyče / Univerzalni ključ za vezno palico / Universalus veržiaraktis / Universālais kaklasaites stieņa uzgriežņu atslēga / Universaalne sidetangi mutrivõt / Универсален гаечен ключ за връзка / Univerzalni ključ za sponu / Универсални ключ за вууч / Γενικό κλειδί ράβδου σύνδεσης / Llave universal para tirantes / Chiave universale per tiranti / Universele spoorstangsleutel



Ref.	☒	EAN
11-875	1/40	5907558477191



Separator

Spreader / Abscheider / Съемник / Сепаратор / Fémunkahenger visszanyomó tárcsafékhéz / Separator / Separátor / Separátor / Separator / Separatorijs / Separators / Separador / Сепаратор / Separator / Separator / Διαχωριστής / Separador / Separatore / Separador / Séparateur / Separator

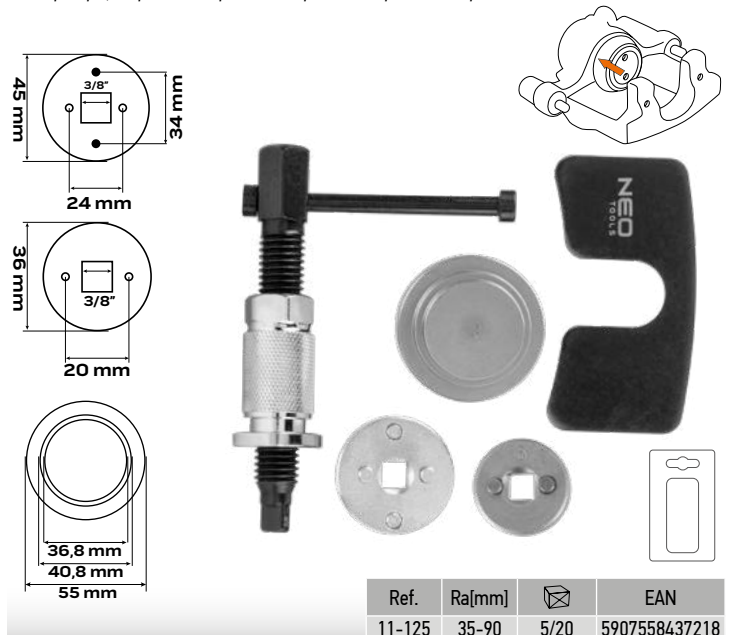

Ref.	Ra[mm]	☒	EAN
11-125	35-90	5/20	5907558437218



Ref.	Ra[mm]	☒	EAN
11-126	25-60	5/20	5907558437232

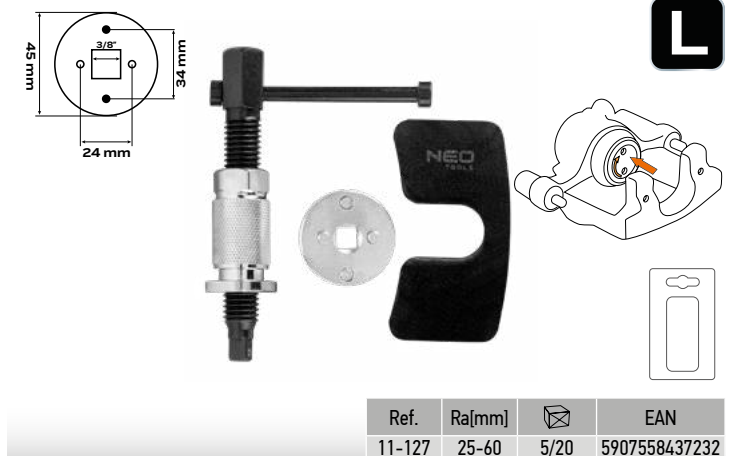

Ref.	Ra[mm]	☒	EAN
11-127	25-60	5/20	5907558437232



Ref.	Ra[mm]	☒	EAN
11-128	40-70	1/20	5907558437249

Zestaw ręcznych separatorów do zacisków hamulcowych

Set of hand separators for brake calipers / Bremskolbenrückstellersatz / Комплект приспособлений для обслуживания тормозных цилиндров / Набор ручных сепараторов для гальмювних колодок / Tárcsafék szerelő és visszanyomó készlet / Set manual de separatori la cleme de frană / Sada na montáž kotoučových brzd / Súprava na montáž kotúčových brzd / Set ročnih ločevalnikov zavornih batov / Stabdžij cilindru suspaudimo komplektas / Bremžu cilindru manuālo separatoru komplekts / Piduriklotside sepaaratorite komplekt / Комплект ручни сепаратори за спирачните клеми / Set ručnih odvajaca za kočione stezaljke / Pribor ručnih separatora za kočione stezače / Σε συντήρησης κυλίνδρων πέδησης / Juego de separadores manuales para las pinzas de freno / Utensili per il riposizionamento dei pistoncini dei freni / Jogo de separadores manuais para maxilas de travão / Jeu de séparateurs manuels pour étriers de freins / Set voor handmatige afstanders voor remklemmen



Ref.	☒	EAN
11-123	0/10	5907558419993



Ref.	☒	EAN
11-122	0/5	5907558419986

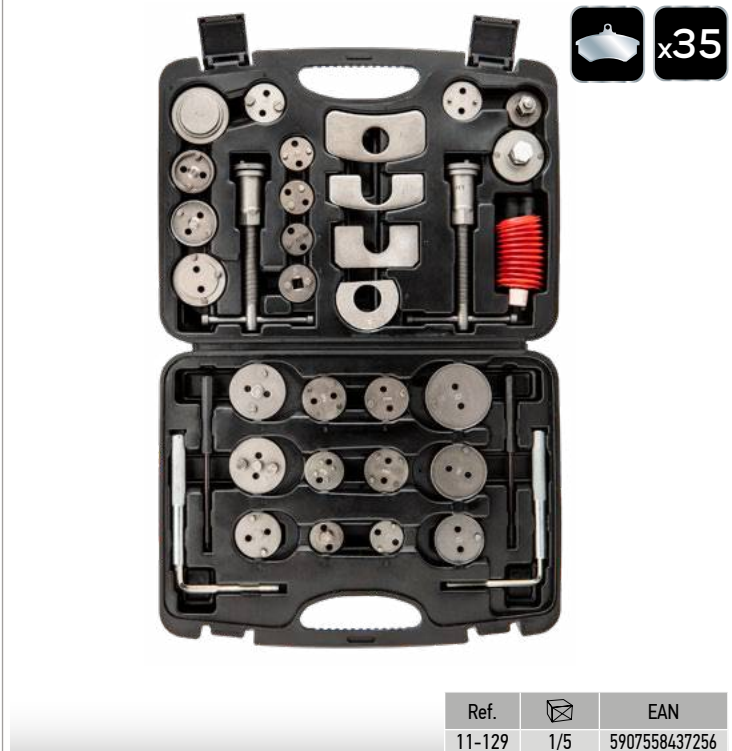

Ref.	☒	EAN
11-129	1/5	5907558437256

Separator pneumatyczny z końcówkami

Air brake caliper wing tool / Einstellwerkzeug für pneumatische Bremszylinder / Инструмент регулировки пневматического тормозного цилиндра / Инструмент регулювання пневматичного гальмівного цилиндра / Pneumatikus fékhenger beállító eszköz / Instrument de reglare a cilindrilor de frână pneumatic / Nástroj pro seřízení pneumatického brzdového válce / Nástroj na nastavenie pneumatického brzdového valca / Orodje za nastavitve pnevmatičnega zavornega valja / Pneumatinis stabdžių cilindro reguliavimo įrankis / Pnevmatisks bremžu cilindra regulēšanas rīks / Pnevmaatlīne pidurislindri regulēerimise tōriist / Пневматичен инструмент за регулиране на спирачния цилиндър / Alat za podešavanje pnevmatskoga kočnog cilindra / Alat za podešavanje pnevmatskoga kočnog cilindra / Εργαλείο ρύθμισης κυλίνδρου πεπιεσμένου αέρα / Herramienta de ajuste del cilindro de freno neumático / Strumento di regolazione del cilindro del freno pneumatico / Ferramenta de ajuste de cilindro de freio pneumático / Outil de réglage du cylindre de frein pneumatique / Luchtremklauw vleugel gereedschap



16
ELEMENTS

L/R

1/4"

Ref.	☒	EAN
11-132	0/5	5907558445435

Zestaw do sprawdzania bicia tarcz hamulcowych

Brake disc run out kit / Prüfsatz für Unrundlauf von Brems Scheiben / Набор для проверки тормозных дисков / Набор для перевірки гальмівних дисків / Tárcsafék ütés mérő készlet / Trusă pentru verificarea bății discurilor de frână / Sada pro kontrolu brzdových kotoučů / Súprava na kontrolu brzdových kotúčů / Komplet za preverjanje zavornih diskov / Rinkins stabdžių diskų patikrinimui / Bremžu disku pārbaudes instrumentu komplekts / Piduriketaste kontrollimise komplekt / Комплект за проверка на биенето на спирачните дискове / Set za provjeru kočionih pločica / Pribor za proveru kočionih diskova / Σετ ελέγχου διακοφρένων / Kit para la comprobación de los discos de freno / Kit per il controllo dell'oscillazione assiale dei dischi freno / Kit de verificação de batimento dos discos de travão / Kit de mesure pour disques de freins / Remschijf opraken kit

±0,01
mm



Ref.	☒	EAN
11-130	1/10	5907558437263

Zestaw do montażu szczęk hamulcowych

Tool kit for brake shoe fitting / Bremsbacken-Montagewerkzeugsatz / Инструмент для обслуживания тормозной системы / Набор для монтажу гальмівних колодок / Fékprofaszerező készlet / Set pentru montarea sabotilor de frana / Sada na montáž brzdových čelistí / Súprava na montáž brzdových čelistí / Set za montažo zavornih čeljusti / Stabdžių trinkelų montavimo rinkinys / Bremžu uzliuku turėtojų montażas komplekts / Pidurikingade paigaldamise komplekt / Комплект за монтиране на спирачните челюсти / Set za montažu kočionih čeljusti / Pribor za montažu kočionih čeljusti / Εργαλεία συντήρησης συστημάτων πέδησης / Kit de montaj de mardzas de frenos / Kit per montaggio pinze del freno / Jogo de ferramentas para montagem de maxilas de travão / Jeu d'outils de montage de mâchoire de frein / Set voor montage van remkaken



Ref.	☒	EAN
11-131	1/5	5907558437270

Ściernice do czyszczenia piast

Wheel hub grinder Schleifmittel zur Reinigung von Naben / Шлифовальные круги для очистки ступицы / Шлифовальні круги для очищення маточин / Kerékagy tisztító dörzstárcsa / Discuri pentru curățarea butucilor / Brusné kotočce pro čišťení nábojů / Brusné kotúče na čistenie nábojov / Bruski za čišćenje pest / Įrankiai ratų stebulių valymui / Ritepa rumbas tirišanas slīpdiski / Rataste puhastamise lihvkettad / Почистиващи четки за главини / Diskovi za čišćenje glavčine / Brusione ploče za čišćenje čvorovišta / Τροχοί λείανσης για καθαρισμό πλῆμης τροχού / Amoladora para limpiar cubos de ruedas / Dischi abrasivi per la pulizia di mozzi / Escovas circulares para limpeza de cubos de rodas / Meules pour nettoyage des moyeux / Wielnaaf grinder voor reiniging

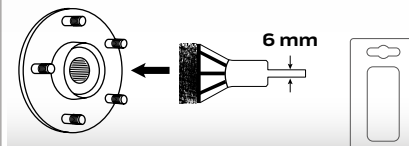

Ref.	☒	EAN
11-135	25/50	5907558437287

ø150
mm 1/2"



11-136

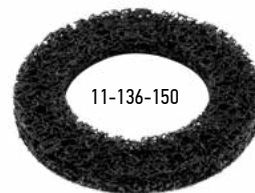

11-136-150

Ref.	☒	EAN
11-136	0/30	5907558411423
11-136-150	0/100	5907558474770

Klucz do kół

Wheel wrench / Radschlüssel / Ключ для колес / Ключ для монтажу нп автомобильных / Kereszt kerékkulcs / Cheie piuliță p/u demontarea și montarea roților / Ključ na kola / Ključ na kolesá teleskopický / Kľuč za automobilsku kolesa / Raktas ratams / Riteru atslēga / Rattavöti / Ключ за гуми / Kľuč za kotač / Kľuč za točak / Ключи για τροχούς / Llave extensible para ruedas / Chiave a croce / Chave para filtro / Clef pour filtre / Wielsleutel

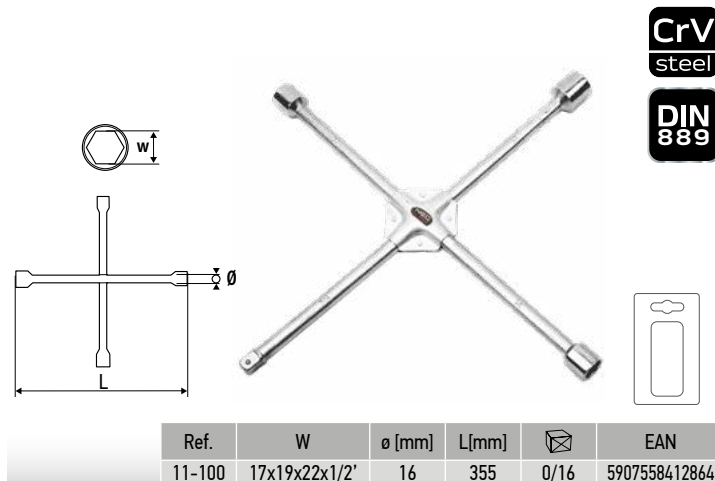

Ref.	W	ø [mm]	L[mm]	📦	EAN
11-100	17x19x22x1/2'	16	355	0/16	5907558412864

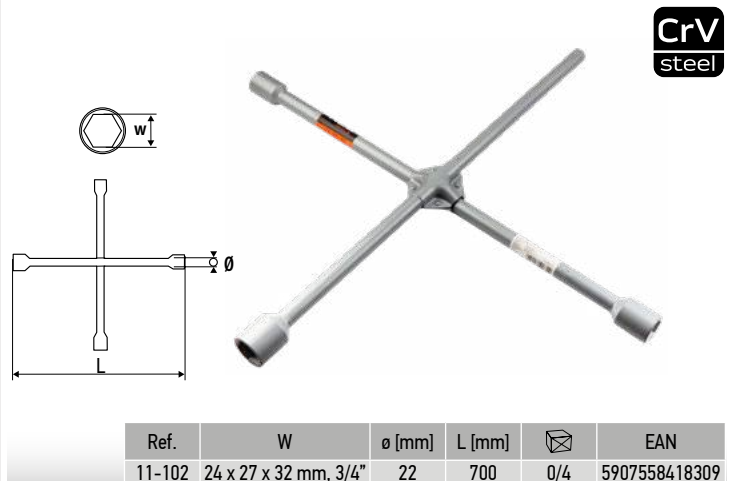

Ref.	W	ø [mm]	L [mm]	📦	EAN
11-102	24 x 27 x 32 mm, 3/4"	22	700	0/4	5907558418309



Ref.	W	📦	EAN
11-101	17x19x1/2'	6/12	5907558417135

Țișca do opon

Wrecking bar / Reifenlöffel / Монтажна автомобильная / Монтувалка / Gumibrancs szerelővas / Levier pentru pneu / Montážní páka na pneumatiky / Páka na pneumatiky / Țișca za pnevatike / Svirts padangy montavimui / Lāpstiņa riepu montāžai / Rehvilusikas / Щанга за демонтаж на гуми / Podizač za montiranje guma / Kašika za gumu / Κουτάλα φανοποιίας / Llave cuchara para extraer ruedas / Leve per pneumatici / Ferramenta para rodas / Demonte-pneus / Breekijzer

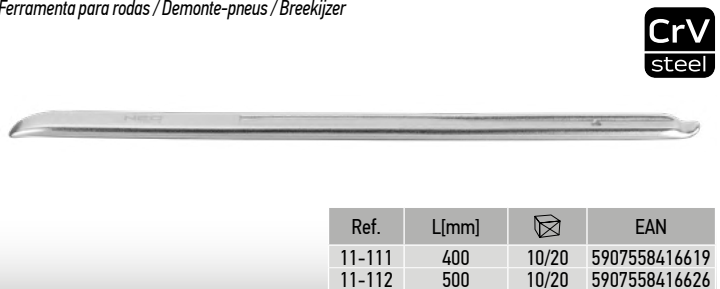

Ref.	L[mm]	📦	EAN
11-111	400	10/20	5907558416619
11-112	500	10/20	5907558416626

Ściągacze do sprężyn

Spring pullers / Abzieher für Feder / Съёмные приспособления для пружин / Знімачі пружин / Rugóösszehúzó kézi / Ancore de arcuiri / Stahováký pružin / Stahováký pružin / Izvlekači za vzmeti / Spyruoklių spaustai / Atsperu porėmata ierėce / Vedrutõmmitsad / Скобы за пружини / Skidači za opruge / Stega za oprugu / Εξωλέκας ελασπίων / Extractor de muelles / Pressori per molle / Ponta de aperto para molas / Extracteurs de ressorts / Trekkers voor veren



Ref.	Ra[mm]	📦	EAN
11-796	23-280	1/5	5907558436747



- 70/130 mm, 90/150 mm Mercedes
- W123, W124, W126, W140, W202, W210
- W107, W114, W115, W116, W123, W124, W126, W129, W140, W201, W202, W203
- Opel / Vauxhall / Hyundai / Lada / Rover / Saab / Fiat / Ford / Mazda / Toyota / Nissan / Mitsubishi / Peugeot / Volo / VW

Ref.	Ra[mm]	📦	EAN
11-798	70-130; 90-150	1/2	5907558436761

Ściągacze do sprężyn

Spring pullers / Abzieher für Feder / Съёмные приспособления для пружин / Знімачі пружин / Rugóösszehűző kézi / Ancore de arcuiri / Stahovákky pružin / Stáhovákky pružin / Izvlekači za vzmeti / Spyruoklių spaustai / Atsperu noņemama ierīce / Vedrutāmmitsad / Скоба за пружину / Skidači za opruge / Stega za oprugu / Εξολκείας ελατηρίων / Extractor de muelles / Pressori per molle / Ponta de aperto para molas / Extracteurs de ressorts / Trekkers voor veren

125-212
88-160
65-125
mm



 125/212 mm, 8/160 mm, 65/125 mm.

 BMW: E31 - E67, MINI R50/R52/R53, Fiat, Alfa Romeo, Chrysler, Lancia, Ford, Mazda, Honda, Hyundai, Jaguar, Jeep, Kia, Mercedes C/E, Citroen, Peugeot, Opel, Vauxhall, Saab, Renault, Nissan, Infiniti, Dacia, Mitsubishi, Rover, Subaru, Toyota, Audi, Porsche, Skoda, VW, Volvo

Ref.	☒	EAN
11-797	1/1	5907558436754

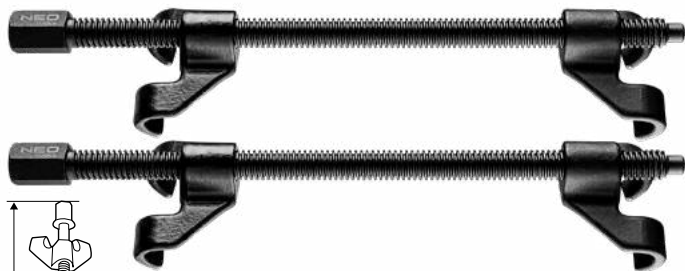

Ref.	L[mm]	☒	EAN
11-807	300	0/10	5907558418453

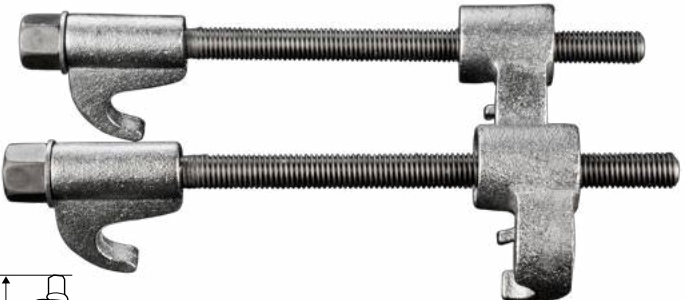

Ref.	L[mm]	☒	EAN
11-808	300	0/10	5907558418460

Dźwignia do przegubów

Lever for articulated joints / Hebel für Gelenke / Рычаг для шарниров / Вахсьль до шарниря / Gömbfejzerezeli villa / Levier de articulație / Podpěra kloubů / Páka k čarom / Vilice za zglobe / Vyrių svirtis / Šarniuru svira / Klambrikang / Лост за шарниру / Poluga za zglobove / Poluga za zglobove / Μοχλός μεντεσέδων / Palanca para rótulas / Leva per giunti articolati / Alavanca p. Articulações / Levier pour articulations / hefboom voor spilverbindingen

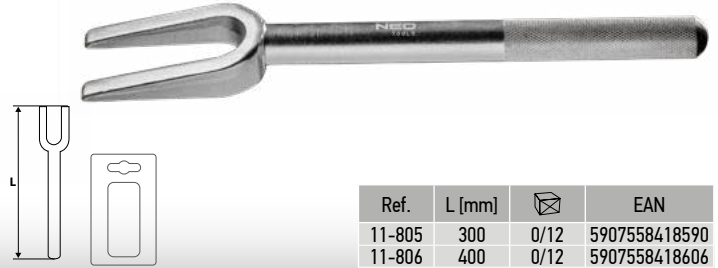

Ref.	L [mm]	☒	EAN
11-805	300	0/12	5907558418590
11-806	400	0/12	5907558418606

Zestaw łomów

Go-through pry bar set / Brechstangen-set / Набор монтажек / Набор ломів / Feszítővas készlet / Set de răngji de oțel / Sada pačidel / Súprava pačidiel / Komplet lomilk / Laužtuvų rinkinys / Laužu komplekts / Kangide komplekt / Комплект щанги / Set poluga / Garnitura poluga / Σετ κουτάλες / Juego de palancas / Set di leve da sforzo / Kit de pés-de-cabra / Jeu de pieds-de-biche / Set van breekijzers



CrV
steel **x4**

Ref.	L[mm]	☒	EAN
11-113	200, 300, 450, 600	0/10	5907558416633

Ściągacz do przegubów

Ball joint puller / Gelenkabziehvorrichtung / Съёмник шарниров / Пристрій для зняття шарнірів / Gömbcsukló kinyomó / Extractor articulații sferice / Stáhovák kloubů / Stáhovák na gulavé čapy / Snematec / Nuëmiklis šarnyrams / Novilcējs / Kuullidestõmmits / Скоба за болтове / Izvlekač / Radarçiger / Κροκοπάλαγο για καστανιές / Extractor de juntas de rótula / Estrattore di giunti a sfera / Ponta de aperto de articulações / Arrache-articulations / Trekker voor spilverbindingen

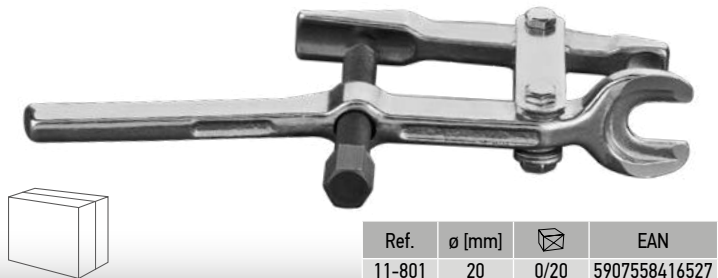

Ref.	ø [mm]	☒	EAN
11-801	20	0/20	5907558416527

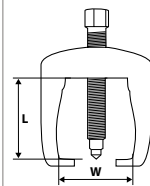

Ref.	L [mm]	W [mm]	☒	EAN
11-803	45	27	0/20	5907558418439
11-804	65	32	0/20	5907558418446



Ref.	ø [mm]	☒	EAN
11-802	19	0/20	5907558418422

Ściągacz do koła kierownicy

Steering wheel puller / Abzieher für Lenkrad / Съёмное устройство рулевого колеса / Знімач керма / Kormánykerék leszedő készlet / Ancoră de volan / Stahovák volantu / Stahovák volantu / Izvlekač za volan / Vairo traukės nuėmiklis / Stūres rata noņemama ierīce / Juhtratta tõmmits / Скоба за колелото на волана / Skidač kotača volana / Stega za upravljač / Εξωλέκας τιμονιού / Extractor de volante / Estrattore di volante / Ponta de aperto para volante / Extracteur de volant / Trekker voor stuurwiel

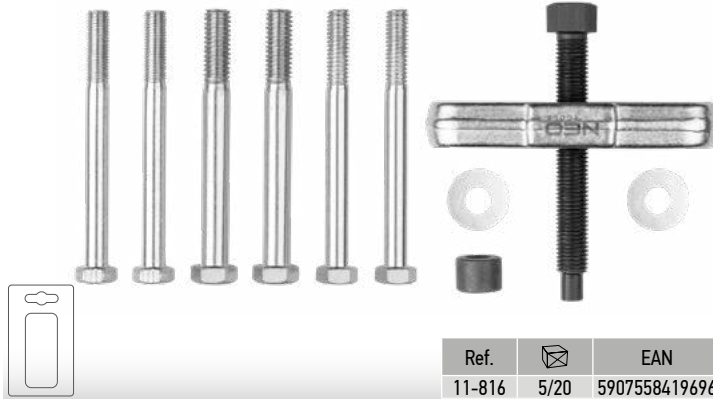

Ref.	📦	EAN
11-816	5/20	5907558419696

Ściągacz z siłownikiem

Hydraulic puler / Abzieher mit Servoantrieb / Съёмник с гидроприводом / Знімач із гідроприводом / Lehúzó hidraulikus rásegítéssel / Extractor cu dispozitiv de acționare / Hydraulický stahovák / Stahovák so servomotorom / Hidraulični izvlekač / Hidraulinis nutraukiklis / Novilcējs ar hidropiedziņu / Servomotoriga tõmmits / Инструмент за демонтаж с цилиндър / Skidač sa cilindrom / Alatka za skidanje sa hidraulikom / Υδραυλικός εξωλέκας / Extractor con accionador / Estrattore con cilindro / Extrator com acionador / Extracteur avec vérin / Hydraulische trekker

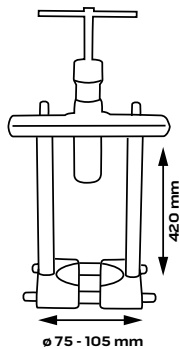

Ref.	📦	EAN
11-847	1/2	5907558436853

Ściągacz do piast

Wheel hub puller / Abzieher für Radnaben / Съёмное приспособление для ступиц / Знімач маточин / Kerékagy lehúzó készlet / Ancoră de butuc / Stahovák hlavy kola / Stahovák náboja / Izvlekač za pesta / Stebulių sprastai / Rumbu noņemama ierīce / Rattarummi tõmmits / Скоба за втулки / Skidač za glavčine / Stega za glavčine / Εξωλέκας πλήμες / Extractor de cubos de ruedas / Estrattore a bilanciere / Ponta de aperto / Extracteur de moyeux / Trekker voor naaf



Ref.	📦	EAN
11-811	5/20	5907558418484

Zestaw ściągaczy do drążków kierowniczych

Steering rods puler set / Abziehvorrichtungssatz für Spurstangen / Набор съёмников шаровых опор и рулевых наконечников / Набор знімачів до нермових тяг / Kormányösszekötő-gömbfejkinnyató készlet / Set trágátoare bare de comandă / Sada stahováků táhel řízení / Sada stahováků tiahel riadenia / Set izvlekačev za krmilne drogove / Guolinijū atramų ir vairo traukių nuėmimo rinkinys / Stūres uzgaļu un sfērisko balstu novilcēju komplekts / Roolivarda tõmmitsate komplekt / Комплект скобы за изваждане на кормилни щанги / Set skidača za upravljačke šipke / Pribor alatki za skidanje upravljačkog stalka / Σετ εξωλέκων σφαιρικών αρθρώσεων και κατευθυντήριων ραβδών / Juego de extractores de barras de dirección / Kit di estrattori per tiranti dello sterzo / Kit de extractores de barras de direção / Kit d'extracteurs de biellette de direction / Trekkers voor stuurstangen



Ref.	📦	EAN
11-799	1/2	5907558436778

Uniwersalny zestaw do centrowania sprzęgła

Universal clutch centring kit / Universal-Kupplungszentriersatz / Универсальный комплект для центрирования сцепления / Универсальный набор для центрування зчеплення / Univerzális tengelykapcsoló centráló készlet / Kit universal de centrare a ambreiajului / Univerzální sada pro centrování spojky / Univerzálna súprava na centrovanie spojky / Univerzalni komplet za centriranje sklopke / Universalus sankabos centravimo rinkinys / Universāls sajūga centrēšanas komplekts / Universaalne siduri tsentreerimiskomplekt / Универсален комплект за центриране на съединителя / Univerzalni komplet za centriranje kvaciła / Univerzalni komplet za centriranje kvacičla / Kit κεντραρίσματος συμπλέκτη γενικής χρήσης / Kit de centrado de embrague universa / Kit di centraggio frizione universale / Kit universal de centragem da embraagem / Kit universel de centrage d'embrayage / Universele koppelings centreerset



∅
15-28
mm



x3



Ref.	📦	EAN
11-172	6/24	5906692019380

Ściągacz dwuramienny i separator

Gear puller set / Abzieher mit zwei schenkeln und ausscheider / Съёмник универсальный с сепаратором / Знімач двоуплечевий і сепаратор / Csapágylehúzó készlet / Extractor universal cu două brațe și separator / Sada dvouramenný stahovák a oddělovač / Súprava dvojrarmenný stahovák a separátor / Komplet dvokrakega smetalca in ločilnika / Dvišakių nuėmėjų rinkinys su separatorium / Dviplacu novilcēja un separatora komplekts / Kaheharuline tõmmits ja separaator / Комплект двураменно стяга със сепаратор / Set dvokraki skidač i separator / Garnitura dvokraka stega i separator / Εξωλέκας γενικής χρήσης με διαχωριστή / Juego de extractores de dos brazos y separador / Set separatore per cambio / Kit sacador de 2 garras e separador / Jeu d'extracteurs a 2 bras et separateur / Tweearmig trekker en separator



Ref.	📦	EAN
11-810	0/4	5907558416572

Ściągacz trójramienny

Three-arm puller / 3-Arm Abzieher / Съёмник с тремя захватами / Знімач триницепевий / Csapágyelhűző, háromkarmos / Extractor cu trei brațe / Трёхрамный стahовák / Trojramenný stahovač / Trokraki snemalec / Trižiaunis nutraukiklis / Trīspļecu novilcējs / Kolmeharuline tōmmits / Тривраменна скоба / Trokraki izvlačač / Trokraki alat za skidanje / Εξολκείας με τρεις σιαγόνες / Extractor de tres brazos / Estrattore a tre griffe / Extractor de três braços / Arrache à trois branches / Driearmig trekker

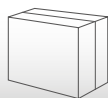
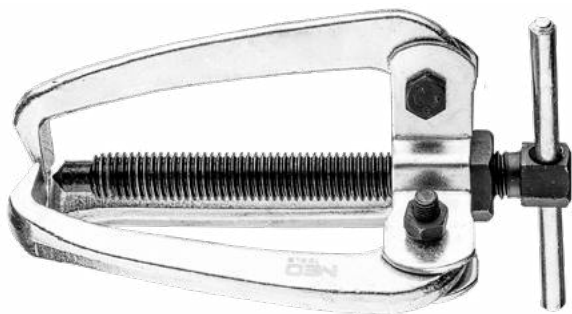

Ref.	L[mm]	☒	EAN
11-868	25	0/50	5907558420128
11-869	50	0/50	5907558420135
11-870	75	0/50	5907558420142

Ściągacz dwuramienny

2 jaws puller / Abzieher mit zwei schenkeln / Съёмник подшипников 2-х лапчатый / Знімач дволицепевий / Csapágyelhűző, kétkarmos / Extractor cu două brațe / Stahovák dvouramenný / Dvojramenný stahovák / Dvokraki snemalec / Nuemējas, divšakis / Divpļecu novilcējs / Kaheharuline tōmmits / Двоураменна скоба / Dvostruki odvajač / Dvokraka stega / Εξολκείας έναφαιρων τριβών με 2 σιαγόνες / Extractor de dos brazos / Estrattore a due griffe / Sacador de 2 garras / Extracteur a 2 bras / Tweearmig trekker

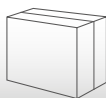

Ref.	L[mm]	☒	EAN
11-871	25	25/100	5907558420159
11-872	50	25/100	5907558420166
11-873	75	25/50	5907558420173

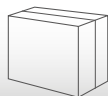

Ref.	L[mm]	☒	EAN
11-857	150	0/16	5907558416862
11-858	200	0/6	5907558416879
11-859	300	0/2	5907558416886

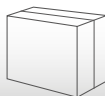

Ref.	L[mm]	☒	EAN
11-850	75	0/50	5907558416817
11-851	100	0/50	5907558416824
11-852	150	0/50	5907558416831

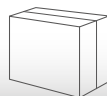

Ref.	L[mm]	☒	EAN
11-861	100	0/20	5907558416794
11-862	150	0/10	5907558416800

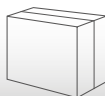

Ref.	L[mm]	☒	EAN
11-865	100	0/16	5907558418514
11-866	110	0/12	5907558418521
11-867	140	0/12	5907558418538

Ściągacz do łożysk

Gear puller / Lagerabziehvorrichtung / Съемник подшипников / Пристрій для зняття підшипників / Csapágylehúzó / Extractor elicoidal / Stahovák ložisek / Stahovák dvojitenný / Snetalec / Guolių nuėtiklis / Novilcėjs gultniem / Hammasratta tōmmitis / Скоба за лагери / Izvlakač / Radapciger / Кρικοπάλακο για άξονες τριβής / Extractor de cojinetes / Estrattore rapporti / Ponta de aperto para rolamentos / Arrache-roulements / Lageronderbank

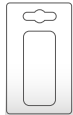
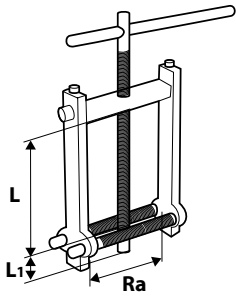

Ref.	L [mm]	L ₁ [mm]	Ra [mm]	☒	EAN
11-813	100	20	24 - 55	0/30	5907558418507



Ref.	Ra [mm]	☒	EAN
11-848	35-130	1/2	5907558436860

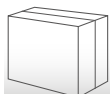
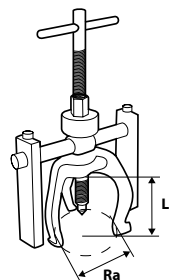

Ref.	L [mm]	Ra [mm]	☒	EAN
11-812	70	18 - 43	0/20	5907558418491

Zestaw do ściągania i instalowania łożysk

Bearing removal and fitting kit / Radlager-Werkzeug-Satz / Набор для снятия/установки подшипников / Набор для зняття та встановлення вальниць / Csapágyszerező szerszámkészlet / Set de dispozitive de scos si de instalat lagare / Sada pro vjtměnu a montáž ložisek / Súprava na demontáž a inštaláciu ložísk / Set za snemanje in montažo ležajev / Guolių montavimo komplektas / Gultņu novikššanas un instalēšanas komplekts / Laagrite eemaldamise ja paigaldamise komplekt / Комплект за стязане и инсталлиране на лагери / Set za skidanje i instaliranje ležaja / Pribor za skidanje i instaliranje ležišta / Σετ τοποθέτησης/αφαίρεσης τριβέων / Juego para extraer e instalar rodamientos / Kit estrazione e montaggio cuscinetti / Jogo de ferramentas para remover e instalar rolamentos / Jeu d'arrache-roulement et de monte-roulement / Set voor demontage en installatie van lagers



Ref.	Ø [mm]	☒	EAN
11-690	50, 55, 60, 64, 67, 70, 72, 74, 75, 78, 82, 84, 88	1/2	5907558436624



Ref.	Ø [mm]	☒	EAN
11-691	18, 19, 20, 21, 22, 23, 24, 25, 26, 27, 28, 29, 30, 31, 32, 33, 34, 35, 36, 37, 38, 39, 40, 41, 42, 43, 44, 45, 46, 47, 48, 49, 50, 51, 52, 53, 54, 55, 56, 57, 58, 59, 60, 61, 62, 63, 64, 65	1/1	5907558436631

Indukcyjna grzałka do śrub

Induction bolt and screw heater / Induktives Heizgerät für Schrauben / Индукционный нагреватель / Нагрівач індукційний / Indukciós hevítő készlet / Incalzitor cu inductie pentru șuruburi / Indukčni ohrev šroubů / Indukčný ohrievač pre skrutky / Indukcijski grelnik za vijake / Indukcinis šildytuvas varžtams / Indukcijas šildītājs / Induktsioon-põldisoojendi / Индукционен нагревател за болтове / Indukcijski grijač za vijke / Indukcioni grejač za šrafove / Επαγωγικός θερμαντήρας / Calentador de inducción para tornillos / Riscaldatore ed induzione per viti / Aquecedor de indução para parafusos / Pistolet à chaleur inductive pour vis / Inductie dompelaar voor schroeven

700°C 1200W

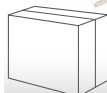
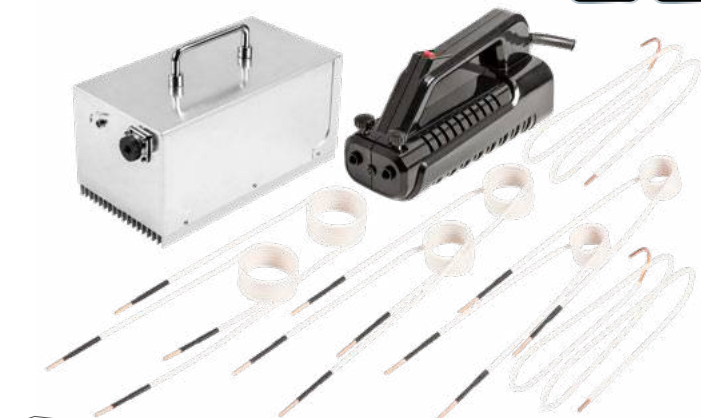

Ref.	☒	EAN
11-931	0/1	5907558436969

Zestaw do naprawy gwintów

Thread repairing kit / Gewindereparatursatz / Набор для восстановления резьбы / Набір для відновлення гвинтованих з'єднань / Menetjavító készlet / Set de rectificat fileturi / Sada pro opravu závitů / Súprava na opravu závitov / Set za popravo navojev / Srigijmo įrankių rinkinys / Skrūvių remontkomplekts / Keertparanduskomplekt / Комплект за ремонт на резьби / Set za popravak navoja / Pribor za popravku šrafova / Σετ αποκτάστας επερωμάτων μ5 / Juego de reparación de tornillos / Kit riparazione filetti / Jogo de ferramentas para reparacão de roscas / Kit de réparation de taraudages / Schroefdraad herstelset



CrV steel



Ref.	Ø	☒	EAN
11-901	M6	10/40	5907558419870
11-902	M8	10/40	5907558419887
11-903	M10	10/40	5907558419894
11-904	M12	10/40	5907558419900

Wkłady do naprawy gwintów

Thread repairing kit / Gewindereparatureinsätze / Набор резьбовых вставок / Набір для відновлення гвинтованих з'єднань / Menetjavító betét / Adausuri de rectificat fileturi / Vložky pro opravu závitů / Vložky na opravu závitov / Set za popravo navojev / Srigijmo galvučių rinkinys / Leliktni vītnu remontam / Keertparandustüübid / Елементи за ремонт на резьби / Umetci za popravak navoja / Umetak za popravku / Σετ ένθετα επερωμάτων / Repuestos para reparación de tornillos / Kit riparazione filetti / Cartuxos para reparacão de roscas / Inserts de réparation de taraudages / Inzetdelen voor schroefdraad herstel



Ref.	Ø	N	☒	EAN
11-905	M5	20	50/250	5907558419917
11-906	M6	20	50/250	5907558419924
11-907	M8	20	50/250	5907558419931
11-908	M10	20	50/250	5907558419948
11-909	M12	10	50/250	5907558419955

Narzynki i gwintowniki

Tap and die set / Schneideisen und Gewindebohrer / Плашки и метчики / Позначники й плашки, набір / Menetkészítő készlet / Set scule tăiere filet interior și exterior / Závítnice a zavitníky / Súprava zavitníkov / Garnitura vreznikov in nareznikov navoja / Sriegijpovės ir sriegikliai / Vitngriežu komplekts / Kraani ja valuvormi komplekt / Метчици и плашки / Nareznice i ureznice set / Set ureznika i nareznika / Ελικοκόπιτες και κολλαούζα / Cojinetes y machos de roscar, juego / Madreviti e maschi / Cassonetes e roscas / Filières et tarauds / Snijplaat en schroefdraad snijtoestel

x110



M2x0,4; M3x0,5; M4x0,7; M5x0,8; M6x0,75; M6x1,0; M7x0,75; M7x1,0; M8x0,75; M8x1,0; M8x1,25; M9x0,75; M9x1,0; M9x1,25; M10x0,75; M10x1,0; M10x1,25; M10x1,5; M11x0,75; M11x1,0; M11x1,25; M11x1,5; M12x0,75; M12x1,0; M12x1,25; M12x1,5; M12x1,75; M14x1,0; M14x1,25; M14x1,5; M14x2,0; M16x1,0; M16x1,5; M16x2,0; M18x1,5;



M2x0,4; M3x0,5; M4x0,7; M5x0,8; M6x0,75; M6x1,0; M7x0,75; M7x1,0; M8x0,75; M8x1,0; M8x1,25; M9x0,75; M9x1,0; M9x1,25; M10x0,75; M10x1,0; M10x1,25; M10x1,5; M11x0,75; M11x1,0; M11x1,25; M11x1,5; M12x0,75; M12x1,0; M12x1,25; M12x1,5; M12x1,75; M14x1,0; M14x1,25; M14x1,5; M14x2,0; M16x1,0; M16x1,5; M16x2,0; M18x1,5

Ref.	☒	EAN
11-915	1/3	5907558436907



M3-M12

DIN223
DIN352

32
PCS

HSS

Ref.	☒	EAN
12-915	1/10	5907558483291

Oprapka do narzynek

Handle for die / Schneideisenfassung / Вороток для плашек / Вороток для плашки / Menetkészítő hajtós / Míner filiera / Objímka zavitnic / Vratidlo na očká / Ročaj za nareznike navoja / Sriegijpovės rėmas / Vitngriežu turėtājs / Valuvormi käepide / В'єрток за плашки / Držac nareznica / Okretac nareznika / Χειρολαβή για ελικοκόπιτη / Terraaja de cojinetes / Impugnatura per filettatrice / Armadura p. Cassonetes / Monture de filière / Kader voor snijplaten

M3-M12 #45 STEEL TWISTING FORCE HIGH STRENGTH



Ref.	☒	EAN
12-909	10/100	5907558483314

Adapter do gwintowników

Adapter for threading dies / Adapter für Gewindeschneidbacken / Адаптер для резьбонарезных плашек / Перехідник для різьбонарізних плашок / Adapter menetes szerszámtokhoz / Adaptor pentru matrijă de filetare / Adaptér pro závitníky / Adaptér pre závitníky / Adapter za navojne matrice / Adapteris sriegimo įrankiams / Adapteris vītru vītņotājiem / Adapter keermestusmasinate jaoks / Адаптер за резбонарезни матрици / Adapter za slavinu / Тан адаптер / Προσαρμογέας για μήτρες σπειρώματος / Adaptador para terrajas de roscar / Adattatore per filiere / Adaptador para matrices de roscar / Adaptateur pour filières / Adapter voor draadstijfen



Ref.	Info	☒	EAN
12-904	1/4"DR M3-M8		5907558477276
12-905	1/4"DR M5-M12		5907558477283
12-906	3/8"DR M5-M12		5907558477290
12-907	1/2"DR M13-M19		5907558477306

Pokrętło do gwintowników

Handle for hand tap / Gewindebohrergriff / Вороток для метчиков / Вороток для позначника / Menetűró hajtvóvas / Manivelă burghiu manual / Vratidlo k závitníkům / Vratidlo na závitníky / Ročaj za vreznike navoja / Rankena sriegikliams / Vītrgrieža turētājs / Käsikraani käepide / Върток за метчик / Držac Ureznica / Okretac ureznika / Χειρολαβή για κολαούζο / Manivela para machos de roscar / Impugnatura per filetto / Chave para machos / Tourne-à-gauche / Draaiknop voor draadtap



Ref.	☒	EAN
12-908	25/100	5907558483321



Ref.	☒	EAN
12-910	10/100	5907558483307

Przedłużacz bębnowy

Extension cord / Verlängerungskabel / Удлинительный кабель / Подовжувач / Hosszabbító kábel / Cablu prelungitor / Prodlužovací kabel / Predlžovací kábel / Podaljševalni kabel / Prailginimo kabelis / Pagarinātājs / Pikenuduskaabel / Удължителен кабел / Produžni kabel / Продужни кабл / Καλώδιο επέκτασης / Cable alargador / Cavo di prolunga / Cabo de extensão / Câble d'extension / Verlengkabel



Ref.	Info	☒	EAN
90-170	20m, 3x1.5mm ²	0/2	5907558426526
90-171	30m, 3x1.5mm ²	0/2	5907558426533
90-172	40m, 3x1.5mm ²	0/2	5907558426540
90-173	30m, 3x2.5mm ²	0/2	5907558426557
90-174	40m, 3x2.5mm ²	0/2	5907558426564
90-175	50m, 3x2.5mm ²	0/2	5907558426571

Przedłużacz listwowy

Extension cable / Verlängerungskabel / Удлинительный кабель / Подовжувач / Hosszabbító kábel / Cablu prelungitor / Prodlužovací kabel / Predlžovací kábel / Podaljševalni kabel / Prailginimo kabelis / Strip extender / Удължителен кабел / Strip produžni kabel / Скините продужни кабл / Επέκταση καλωδίου / Cable alargador / Cavo di prolunga / Cabo de extensão / Câble d'extension / Verlengkabel

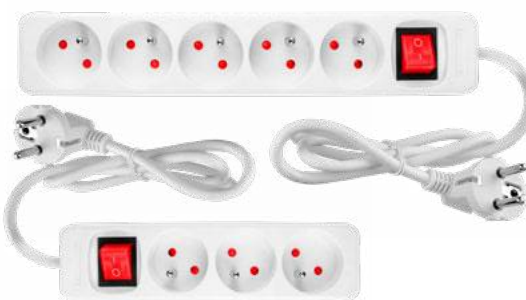

Ref.	Info	☒	EAN
90-176	1.5m, 3x1.5mm ² , 3G,	0/40	5907558474923
90-177	1.5m, 3x1.5mm ² , 5G,	0/40	5907558474930
90-178	3m, 3x1.5mm ² , 3G,	0/40	5907558474947
90-179	3m, 3x1.5mm ² , 5G,	0/40	5907558474954
90-180	5m, 3x1.5mm ² , 3G,	0/30	5907558474961
90-181	5m, 3x1.5mm ² , 5G,	0/30	5907558474978



Ref.	Info	☒	EAN
90-182	1.5m, 3x1.5mm ² , 3G,	0/40	5907558474985
90-183	3m, 3x1.5mm ² , 3G,	0/40	5907558474992
90-184	1.5m, 3x1.5mm ² , 4G,	0/40	5907558475005
90-185	3m, 3x1.5mm ² , 4G,	0/40	5907558475012

Przewody rozruchowe

Booster cables / Akku-Zusatzleitungen / Стартовые провода / Шнури аварійного пуску акумулятора / Indítókábel réz / Conductori de avarie pentru acumulator / Kabely pro nouzové startování k akumulátoru / Pomocné káble do akumulátora pre núdzový štart / Vžigalni kabli / Automobilio užvedimo laidai / Palaišanas vadi akumulatoram / Aku avariijuhtmed / Аварійні проводниці за акумулятора / Rezervni kablovi za akumulator / Hitni kabl za akumulator / Καλώδια έκτακτης ανάγκης για ηλεκτρική συσσωρευτή / Cables puente para la batería / Cavi di emergenza per la batteria / Cabos de emergência para bateria / Câbles de démarrage pour batterie

2.5m

Cu



Ref.	A max	☒	EAN
11-834	200	0/6	5907558436815
11-836	600	0/5	5907558436822



Tester akumulatorów

Battery load tester / Batterietester / Τεστερ μπαταρει / Τεστερ акумулятора / Akkumulátor tesztelő / Tester de încercare a bateriei / Tester baterii / Tester batterie / Tester akumulatorja / Akumulátorias baterijos testeris / Akumulatoru bateriju testeris / Aku tester / Τεστερ на батеријата / Ispitivač baterije / Испитивач батерије / Ελεγκτής φορτίου μπαταρίας / Comprador de carga de batería / Tester di carico della batteria / Testador de carga da bateria / Testeur de charge de batterie / Acculaadtester



for
6/12V
batteries

100A

VOLTAGE
ACCURACY
±0.2V

ANALOG
METER
0-16 V DC

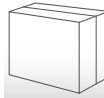

Ref.	A max	☒	EAN
11-984	100	1/10	5907558452402



for all
12V
batteries

125A

VOLTAGE
ACCURACY
±0.2V

DIGITAL
METER
8-16 V DC

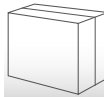

Ref.	A max	☒	EAN
11-985	125	1/10	5907558452419



for all
12V
batteries

Ref.	☒	EAN
11-986	6/36	5907558452419

Prostownik

Car battery charger / Stromrichter / Выпрямитель / Выпрямляч / Egyenirányító / Redresor auto / Usměřovač / Usmerňovač / Usmernik / Įkroviklis / Akumulatora lādētājs / Alaldi / Τοκοιζπρωμεν / Ispravljáč / Ispravljáč / Ανορθωτής / Rectificador / Raddrizzatore carica batterie / Gelijkrichter

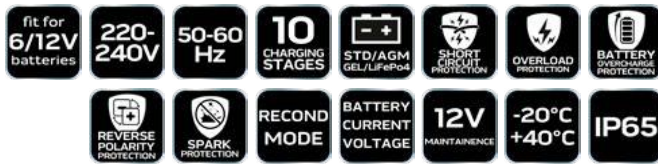

Ref.	[A/W]	Ah	☒	EAN
11-891-1	4/70	3-120	1/10	5907558495126
11-892-1	6/100	3-150	1/10	5907558495126
11-893-1	10/160	3-200	1/10	5907558495140

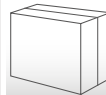

Ref.	☒	EAN
11-890	0/10	5907558463279

Próbnik elektryczny samochodowy

Car voltage tester / Kfz-Spannungsprüfer V / Индикатор напряжения / Индикатор напруги автомобільний / Járműfázisceruza / Sonda de luat probe la instalații electrice la automobile / Zkoušečka napětí autoelektrikářská / Autoskúšačka / Preizkuševalec napetosti za avtomobile / Elektroninis testeris automobiliams / Automašīnas elektrības testeris / Auto elektritester / Автомобилен фазомер / Električni ispitivač napona / Automobilski električni tester / Συσκευή ένδειξης τάσης / Probador eléctrico para coches / Tester per auto / Testador de tensão para carros / Testeur électrique automobile / Elektrische wagen meetkop



6-24V



Ref.	☒	EAN
11-832	12/240	5907558420418

Poduszka monterska

Mounting Cushion / Montagekissen / Монтажная подушка / Монтажна подушка / Szerelőpárna / Pernő de montaj / Montážní polštářek / Montážny vankúšik / Montažna blazina / Pagalvė montavimo / Montāžas spilvens / Paigalduspadi / Монтажна възглавница / Montažni jastuk / Монтажни јастук / Μαξιλάρι τοποθέτησης / Cojín de montaje / Cuscino di montaggio / Almofada de montagem / Coussin de montage / Montage kussen



MAX 200 kg

METAL VALVE

height 15-60 mm

150 x 165 mm

Ref.	☒	EAN
50-900	0/100	5907558495249

Zestaw blokad rozrządu

Timing tool set / Nockenwellen-Arretierwerkzeugsatz / Набор фиксаторов распределителя для установки фаз ГРМ / Набор стопорів для розподільвальних валів / Vezérműtengely blokkoló készlet / Set de blocarea distribuției / Sada blokovací pro opravu rozvodů / Súpava blokad rozvodov / Set blokad gredi / Paskirstymo velenėlių fiksavimo komplektas / Sadales mehānismu fiksatoru komplekts / Jaotuse blokeerimise komplekt / Комплект блокировки на газораспределителе / Set alata za blokiranje radilice / Pribor za blokadu razvođenja / Σετ συγκράτησης κλιβακοφόρων αξόνων / Kit de bloqueo de la correa de distribución / Attrezzi di blocco dell'albero a camme / Conjunto de bloqueios de engrenagem de distribuição / Ensemble de verrouillage de distribution / Set van distributievergrendeling

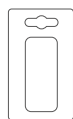

1.2D TDI PD: ANY, AYZ
1.4D TDI PD: AMF, ATL, BHC
1.9D TDI PD: AJM, ANU, ARL, ASZ,
ATD, ATJ, AUY, AVB, AVF, AWX, AXR,
BSW, BTB, BVK

Ref.	📦	EAN
11-300	10/40	5907558436051



TDI
VAG



TDI
VAG



Audi: A1 (10-15), A2 (00-06), A3 (01-13), A4/Allroad (01-16), A5 (08-15), A6 (11-14), TT (08-14), Q3 (11-15), Q5 (08-15), A6 (10-14)
Dodge: Caliber (06-11); Ford: Galaxy (02-06);
Mitsubishi: Grandis (05-10), Lancer (05-10), Outlander (07-10)
Seat: Alhambra (00-15), Altea/Altea XL (04-15), Cordoba (02-09), Ibiza (02-15), Leon (00-13), Toledo (04-11)
Skoda: Fabia (00-14), Fabia II (07-15), Octavia (00-10), Octavia II (04-15), Praktik (10-15), Rapid (11-15), Roomster (07-15), Superb (02-08), Superb II (08-15), Yeti (09-14)
VW: Amarok (10-16), Beetle (02-15), Bora (02-08), Caddy/Maxi (03-15), EOS (06-15), Fox (05-11), Golf (02-15), Golf Plus (05-14), Jetta (05-15), Lupo (02-05), Passat/CC (02-15), Polo (99-14), Scirocco (08-14), Sharan (02-15), Tiguan (07-15), Touran (03-15), Transporter (03-18)



Kody silników / Engine codes / Коды двигателя:

1.2D TDi CR: CFWA
1.4D TDi PD: AMF, BAY, BMS, BNM, BNV, BWB
1.6D TDi CR: CAYA, CAYB, CAYC, CAYD, CAYE, CLNA
1.9D TDi PD: AJM, ANU, ARL, ASZ, ATD, AUY, AVB, AVF, AVQ, AWX, AXB, AXR, AXS, BJB, BKC, BLS, BLT, BMT, BPZ, BRM, BRR, BRS, BRU, BSU, BSV, BSW, BTB, BVK, BXE, BXF, BXJ
2.0D TDi CR/TDi PD: AZV, BDJ, BDK, BEW, BGW, BHW, BKD, BKP, BKQ, BLB, BMA, BMM, BMN, BMP, BMR, BNA, BPW, BRA, BRC, BRD, BRE, BRF, BRT, BSS, BST, BSY, BUY, BUZ, BVA, BVE, BVF, BVG, BVH, BWC, BWW, CAAA, CAAB, CAAC, CAAD, CAAE, CAGA, CAGB, CAGC, CAHA, CAHB, CBAA, CBAB, CBAC, CBBA, CBBB, CBDA, CBDB, CBDC, CBEA, CCHA, CCHB, CDBA, CDCA, CECA, CFCA, CFFA, CFFB, CFFD, CFFE, CFGB, CFGC, CFHA, CFHB, CFHC, CFHD, CFHE, CFHF, CFJA, CGLA, CGLB, CGLC, CGLD, CJAA, CJCA, CJCB, CJCC, CLCA, CLCB, CLJA, CLLA, CNEA, ECD, ECD/BSY, ECD/BYL, ECE/BWD
OEM:
Dodge: 9882, 9883
Ford: 310-085/23-059, 303-1054
Mitsubishi: MB995206, MB995208, MB995209
VAG: T10100, T10050, 3359/T20102, T10115, T10060A/T40098, T20167

Ref.	📦	EAN
11-301	10/40	5907558436068



TDI
VAG



AUDI: A1, A3, A4 (B8), A5, A6 (C6, C7), TT, Q3, Q5
VW: Golf V-VI, Passat B6, B7, Polo, Jetta V-VI,
Scirocco III, Beetle II, Caddy, Touran, Sharan II, T5
SKODA: Fabia, Roomster, Practice, Octavia II,
Superb II, Yeti
SEAT: Ibiza, Leon, Exeo, Altea, Alhambra II



Kody silników / Engine codes / Коды двигателя:
1,6 TDI CR (> 2009): CAYB, CAYC
2,0 TDI CR (> 2007): CAAA, CAAB, CAAC, CBAB, CBBA, CBAB, CFFB, CAGA, CAHA, CAGB, CAHB, CAGC, CCHA, CAVA, CBDA, CBDD, CBAC, CBDC
OEM: T20102 | U40074 | 3359 | T10050 | T10100 | T10264 | T10265 | T40098 | T10051 | T10052 | T10255

Ref.	📦	EAN
11-302	1/5	5907558436075



TDI
VAG



Audi: A4 2,7 TDI (05-09); A4 Quattro 2,0 TDI (05-06); Q7 3,0 TDI (06-09)
Volkswagen: Touareg 3,0 V6 TDI (08-); Phaeton 3,0 V6 TDI (06-); Diesel 2,7 TDI, 2,0 TDI 3,0 TDI



Kody silników / Engine codes / Коды двигателя
2.7TDI V6: BBP, BSG, CAMA, CAMB, CANA, CANC, CAND, CGKA, CGKB
3.0TDI V6: ASB, BKN, BKS, BMK, BMZ, BNG, BUG, BUN, CAPA, CARA, CARB, CASA, CASB, CASC, CATA, CCMA, CCWA, CCWB, CDYA, CDYB, CDYC, CEXA,
4.0TDI V8: ASE
OEM: T40062 | T40061 | T40049 | 3359 | T40058 | T40060 | 3242

Ref.	📦	EAN
11-303	1/5	5907558436082



VAG



Benzyna / Gasoline / Бензин: 1,2 6V/12V / 1,4 16V / 1,6 16V / 1,4FSI / 1,6FSI
Diesel: 1,2TDI / 1,4TDI / 1,9TDI / 2,0TDI / 2,5 V6 TDI / 3,3 V8 TDI / 2,0TDI (PD oraz CR) / 1,6 TDi CR

Kody silników / Engine codes / Коды двигателя

ANY, ASZ, ATD, AMF, ATL, BHC, AXR, AVB, AVX, AWX, AMF, BMS, BNM, BNV, ANU, ARL, AUY, BTB, BVK, BJB, BKC, AZV, BKD, AXB, AXS, BDJ, BST, AJM, AYZ, BWB, BAY, AXG, AXL, AYC, AVQ, BMP, BRM, BRU, BSU, BXE, BXF, BMM, BDK, AZU, BMM, ATJ, BGW, BHW, ACV, AHY, AJ
OEM: T10123 | T10120 | 3458 | 3418 | 2065A | 3366 | T10098 | T10121 | 3242 | T10050 | T10100 | T10060A | T10020 | T10008 | T40011 | 3359 | 2064 | 3369 | T10016 | T10264 | T10265

Ref.	📦	EAN
11-304	1/4	5907558436099



VAG



AUDI: A3, S3, A5, A6, TT (03-11), SEAT: Ibiza, Leon, Altea, Exeo (04-11)
SKODA: Fabia II, Octavia II, Roomster, Superb II (04-11),
VW: Golf, Golf Plus, Jetta, Eos, Scirocco, Tiguan, Touran, Passat (03-11)



Kody silników / Engine codes / Коды двигателя:
2.0FSI: AWA, AXW, BHD, BLR, BLX, BLY, BMB, BVX, BZY, BVZ
2.0TFSI: AXH, BGB, BHZ, BPG, BPJ, BPY, BUL, BWA, BWE, BWJ, BWT, BYD, BYK, BZC, CDLA, CDLB, CDLC, CDLD, CDMA
OEM: T10020 | T10252 | T10092 | T10115 | T10060A | 3366 | T40011

Ref.	📦	EAN
11-306	1/10	5907558436112

Zestaw blokad rozrządu

Timing tool set / Nockenwellen-Arretierwerkzeugsatz / Набор фиксаторов распредела для установки фаз ГРМ / Набор стопорів для розподілювальних валів / Vezérműtengely blokkoló készlet / Set de blocarea distribuției / Sada blokovací pro opravu rozvodů / Súprava blokád rozvodov / Set blokad gredi / Paskirstymo velenėlių fiksavimo komplektas / Sadales mehānismu fiksatoru komplekts / Jaotuse blokeerimise komplekt / Комплект блокировки на газораспределении / Set alata za blokiranje radilice / Pribor za blokadu razvodjenja / Set συγκράτησης κινδωκοφόρων αξόνων / Kit de bloqueo de la correa de distribución / Attrezzi di blocco dell'albero a camme / Conjunto de bloqueios de engrenagem de distribuição / Ensemble de verrouillage de distribution / Set van distributievergrendeling



VAG



Audi: A1 (10-15), A3 (03-13)
Seat: Alhambra (10-15), Altea/Altea XL (08-15), Ibiza/Cordoba (08-12), Leon (07-13), Toledo (07-15)
Skoda: Fabia II (07-15), Octavia II (04-15), Praktik (10-15), Rapid (12-15), Roomster (06-15), Superb II (09-14), Yeti (09-14)
VW: Beetle (11-15), Caddy/Caddy Maxi (10-15), EOS (06-12), Golf (03-12), Golf Plus (03-14), Golf V Estate (07-13), Golf VI Cabriolet (10-15), Jetta (06-14), Passat (05-11), Polo (02-14), Scirocco (08-12), Tiguan (07-12), Touran (03-15)



Kody silników / Engine codes / Коды двигателя:

1.2 TFSI:CBZA, CBZB, CBZC

1.4 FSI:AXU, BKG, BLN

1.4 TFSI:BLG, BMY, BWK, CAVA, CAVB, CAVC, CAVD, CAVE, CAVF, CAXA, CAXC, CDGA, CSMA

1.6 FSI:BAG, BLF, BLP, BTS

OEM VAG: T10170, T10171A, T40011, T10340, T10414

Ref.	📦	EAN
11-305	1/10	5907558436105



VAG



Audi: A3 (2013-)
Seat: Mii (2012-), Leon (2012-), Toledo (2012-)
Skoda: Citigo (2012-), Octavia (2013-), Rapid (2012-)
VW: Up (2012-) and Polo mk5 (2014-), Golf VII (2012-), Jetta (2012-)



1.0 Ecofuel, Ecomotive, Bluemotion, Green Tech
CHYA, CHYB, CPGA

1.2 TFSI: C.JZA,C.JZB

1.4 TFSI: CMBA, CXSA, CHPA

1.4 TGI: CPWA

1.4 TSI Multi Fuel CPVA

1.4 Hybrid CRJA

OEM VAG: T10340, T10477, T10476, T10499, T10494, T10487

Ref.	📦	EAN
11-338	0/2	5907558451214



BMW



BMW 1 Series: 118i E81/82/87/88 (04-14), 120i E81/82/87/88 (04-14)
BMW 3 Series: 316i/ti Compact E46 (01-07), 318i/ti Compact E46 (01-07), 318i E90/91/92/93 (05-12), 320i (E90/91/92/93 (05-14)
BMW 5 Series: 520i E60/61 (07-10)
BMW X Series: X1 E84 sDrive 18i (10-12), X1 E84 xDrive 18i (10-12), X3 E83 2.0 (05-10)
BMW Z Series: Z4 2.0 E85/86 (04-09),



Kody silników / Engine codes / Коды двигателя:

2.0: N42 B18A, N42 B20A, N46 B18, N46 B20, N46 B20B, N46T B20, N46T B20BD, N46T B20BZ, N46T B2002, N46T B202

OEM BMW: 11 9 310 | 11 9 320 | 11 9 302 | 11 9 301 | 11 9 290 | 11 9 302 | 11 9 340 | 11 9 390 | 11 9 350 | 11 9 270 | 11 2 300 | 11 9 190 | 11 9 330

Ref.	📦	EAN
11-313	1/5	5907558436167



VAG



AUDI: A1 - A1 Sportback - A3 - A3 Sportback - A3 CABRIO - S1 - S1 Sportback
SEAT: Alhambra - Altea - Altea XL - Ibiza - Leon - Cordoba - Toledo
SKODA: Octavia II - Praktik - Roomster - Superb II - Yeti - Yeti Outdoor - RAPID - Rapid Spaceback - Superb II
VW: Beetle - Caddy - Caddy Maxi - Eos - Golf Plus - Golf V - Golf V Estate - Golf VI - Golf VI Cabrio - Golf VI Estate - Jetta - Passat - Polo - Scirocco - Sharan - Tiguan - Touran - CC



Kody silników / Engine codes / Коды двигателя:

1.2 FSI/TFSI: CBZA - CBZB - CBZC

1.4 TSI /1.4 / 1.6 FSI: AXU - BAG - BKG - BLF - BLG - BLN - BLP - BMY - BTS - BWK CAXA (03-)

OEM VAG: T10340, T10414, T10171A, T40011, T10170, VAS6079, T10341

Ref.	📦	EAN
11-307	1/5	5907558436129



BMW



116i E81/82/87/88 (07-12), 118i E81/82/87/88 (06-14), 120i E81/82/87/88 (06-14)
BMW 3 Series: 316i E90/91/92/93 (07-11), 318i E90/91/92/93 (07-13), 320i E90/91/92/93 (07-14)
BMW 5 Series: 520i E60/61 (07-10)



Kody silników / Engine codes / Коды двигателя:

N43: B16A/AA, B16AA, B16AA/00, B20A, B20A/AA, B20AA, B20AY, B20K0, B20U0

OEM BMW: 11.8.690 (11.8.691/11.8.692/11.8.693), 11.9.340 (11.9.341/11.9.342), 11.8.710 (11.8.711/11.8.712), 11.3.340, 11.5.120, 11.8.700

Ref.	📦	EAN
11-310	1/5	5907558436136



BMW



BMW 1 Series: 118i E81/82/87/88 (04-14), 120i E81/82/87/88 (04-14)
BMW 3 Series: 316i/ti Compact E46 (01-07), 318i/ti Compact E46 (01-07), 318i E90/91/92/93 (05-12), 320i (E90/91/92/93 (05-14)
BMW 5 Series: 520i E60/61 (07-10)
BMW X Series: X1 E84 sDrive 18i (10-12), X1 E84 xDrive 18i (10-12), X3 E83 2.0 (05-10)
BMW Z Series: Z4 2.0 E85/86 (04-09),



Kody silników / Engine codes / Коды двигателя:

2.0: N42 B18A, N42 B20A, N46 B18, N46 B20, N46 B20B, N46T B20, N46T B20BD, N46T B20BZ, N46T B2002, N46T B202

OEM BMW: 11.9.301, 11.9.303, 11.9.310, 11.9.320, 11.9.390

Ref.	📦	EAN
11-312	1/5	5907558436150

Zestaw blokad rozrządu

Timing tool set / Nockenwellen-Arretierwerkzeugsatz / Набор фиксаторов распределителя для установки фаз ГРМ / Набор стопорів для розподільвальних валів / Vezérműtengely blokkoló készlet / Set de blocarea distribuției / Sada blokovací pro opravu rozvodů / Súprava blokad rozvodov / Set blokad gredi / Paskirstymo velenėlių fiksavimo komplektas / Sadales mehānismu fiksatoru komplekts / Jaotuse blokeerimise komplekt / Комплект блокировки на газораспределителе / Set alata za blokiranje radilice / Pribor za blokadu gazvođenja / Set αλληλάφησης κλιβακοφόρων αξόνων / Kit de bloqueo de la correa de distribución / Attrezzi di blocco dell'albero a camme / Conjunto de bloqueios de engranagem de distribuição / Ensemble de verrouillage de distribution / Set van distributievegrendeling



BMW 1 Series: 125i E88 (07-13), 128i E82/88 (07-08), 130i E81/87 (05-12), 135i/S E82 (07-11), M Coupe (11-12)
 BMW 3 Series: 323i E90/91/92/93 (04-11), 325i E90/91/92/93 (05-13), 328i E90/91/92/93 (04-08), 330i E90/91/92/93 (04-14), 335i E90/91/92/93 (05-11)
 BMW 5 Series: 523i/Li E60/61/F10/11 (04-11), 525i E60/61 (04-10), 528i E60/61/F10/11 (06-11), 530i E60/61/F10/11 (04-13), 535i E60/61 (06-08)
 BMW 6 Series: 630i E63/64 (04-11)
 BMW 7 Series: 730i E65/66 F01/02/04 (04-11), 740i F01/02/04 (08-12)
 BMW X Series: X1 E84 xDrive 20i (11-14), X1 E84 sDrive 20i (11-14), X1 E84 xDrive 28i (11-14), X1 E84 3.0 xDrive25i (10-11), X1 E84 xDrive28i (09-11), X3 F25 20i (11-14), X3 E83 2.5Si (06-10), X3 E83 3.0i/Si (06-10), X3 F25 3.0 xDrive 28i (11-13), X5 E70 3.0Si/xDrive 30i (06-10), X6 E71/72 3.0 xDrive35i (08-10)
 BMW Z Series: Z4 E85/86 2.5i/Si (05-09), Z4 E85/86 3.0i/Si (05-09), Z4 E89 2.5 sDrive23i (09-11), Z4 E89 3.0 sDrive 30i (09-11), Z4 E89 3.0 sDrive 35i/si (09-13)



Kody silników / Engine codes / Коды двигателя:

N52/N52K: B25A, B25A/O1, B25AE, B25AF, B25BE, B2501, B2502, B25U1, B30/O2, B30A, B30A/O1, B30AE, B30AF, B3002, B30U1 N53/N54: B25A, B30A, B30A/AA, B30A/O0, B30A/T0, B3000, B30TD, B30U0
 OEM BMW: 110300 | 114280 | 114281 | 114282 | 114283 | 114290 | 118520

Ref.	📦	EAN
11-311	1/2	5907558436143



BMW: N42 / N46 / N46T - Valvetronic
 Seria 1: E87 118i/120i (04-10)
 Seria 3: E46 316i/316ti Compact, 318ti Compact (01-05), 318i (01-07), E90 318i (05-08)
 Seria 5: E90 520i (04-08), X3 E83 2.0i (05-09)



Kody silników / Engine codes / Коды двигателя:
 N46, B18, B20B, B20, N42, B18A, B20A, N46T
 OEM BMW: 11 3 350 | 11 9 293 | 11 9 292 | 11 9 291 | 11 9 340 | 11 5 120 | 11 9 270 | 11 9 190

Ref.	📦	EAN
11-314	1/5	5907558436174



BMW 1.6 2.0 3.0 d
 118d E81; 118d E87 - (2006-2010)
 120d E81; 120d E82; 120d E87 - (2006-2010)
 123d E81; 123d E82; 123d E87 - (2007-2010)
 318d E90; 318d E91 - (2007-2010)
 320d E90; 320d E91; 320d E92 - (2005-2010)
 520d E60; 520d E61 - (2006-2008)
 X3 2.0d E83 - (2007-2010)



Kody silników / Engine codes / Коды двигателя:

N47; N47S D20A; N57
 OEM BMW: 11 6 480 | 11 8 760 | 11 8 740 | 11 8 741 | 11 8742 | 11 5 320

Ref.	📦	EAN
11-315	1/10	5907558436181



BMW:
 118d / 120d: E87:
 318d / 318td Compact / 320td Compact / 320d / 330d: E46:
 316i: 316ti, 318ci, 318ti, 320i E90/E91:
 318i: 320i E90/E91/E92/E93: 520d / 525d / 530d: E39:
 318tds / 318tds Compact (1994-2000) / 325td / tds (1991-99): E36
 525d / 530d / 535d: E60/E61:
 525td / tds (1991-2003): E34/E39
 635d: E63:
 725tds (1991-2003) M47 / M47 TU / T2 / M57 TU/T2: E38:
 730d: E38/E65/E66:
 X3: 2.0i d / 3.0i d E83:
 X5: 3.0i d E53/E70:
 Land-Rover
 Range Rover: 2.5 DT (1994-2002)
 Range Rover: 3.0 TD6 (2002-2006)
 Freelander: 2.0 TD4 (2002-2006)



Kody silników / Engine codes / Коды двигателя:

M41, M51, M47 - M47 TU/T2, M57 TU/T2: 2.0i / 3.0i - 1998 - 2008
 OEM BMW: 11 2 300 | 11 3 320 | 11 3 340 | 11 3 360 | 11 5 180 | 11 6 080 | 11 6 320 | 11 6 321 | 11 6 322 | 13 5 120 | 13 5 190 | 13 5 192
 OEM Land Rover: LRT-12-108 | LRT-12-112 | LRT-12-115 | LRT-12-114 | LRT-12-119
 OEM Opel: KM-6267 | KM-6269 | KM-6268 | KM-813 | KM-823

Ref.	📦	EAN
11-316	1/2	5907558436198

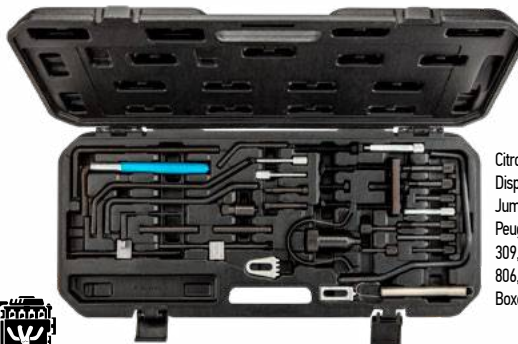

Citroen: AX, ZX, XM, Xsara, Xantia, Dispatch, Evasion, Berlingo, Jumpy, C2, C3, C5 |
 Peugeot: 106, 205, 206, 305, 306, 307, 309, 405, 406, 406 Coupe, 605, 607, 806, 807, Express, Expert, Partner, Boxer.



Silniki / Engines / Двигатели:

Benzyna / Gasoline / Бензин: 1,0 / 1,1 / 1,4 / 1,6 / 1,8 / 2,0 / 2,0 HPI
 Diesel: 1,8 / 1,9 / D / TD 1,4 / 2,0 / 2,2 / HDI 2,1 / 2,2 / 2,5 / TD
 OEM: 4 4507-TJ | 0132X | 9767.89 | 0132X12 | 0132Q | 5711-TA | 4507-TB | 0132R | 9767.27 | 7014-TM | 4507-TA | 0132OZ | 0189-C | 0153G | 0153Y | 0153N | 0188D | 7017-TR | 0118X | 7004-TG | 7014-TJ | 7017-TR | 0132AB | 4527-TS2 | 5711-TD | 0189-B | 5711-TC | 9041-TZ | 0188-H | 4527-T-S1 | 0132AJ2 | 0188M | 4533-TAC2 | 0132AJ1 | 4533TAC1 | 0189-A | 0189AZ | 0189-L | 0188Y | 0288D | 7099-TM | 7014-TJ | 0188P/P2 | 7015T | 0134AF | 0188F | 9044

Ref.	📦	EAN
11-320	1/4	5907558436211



BMW 3 Series: 318tds E36 (94-99), 318tds Compact E36 (95-00), 325td/tds E36 (91-99)
 BMW 5 Series: 525td/tds E34 (91-96), 525td/tds E39 (97-03)
 BMW 7 Series: 725tds E38 (96-02)
 Land Rover: Range Rover (94-02)
 Vauxhall/Opel: Omega-B (94-01)



Kody silników / Engine codes / Коды двигателя:

1.7D: M41/174T1 2.5D: M51/256T1, M51/256T1L 2.5D Turbo: M51, 256T, 25DT, X25DT
 OEM BMW: 11 2 150, 13 5 062, 11 3 340, 11 3 360, 11 3 320, 13 5 120, 11 2 300
 OEM Land Rover: LRT-12-118, LRT-12-112, LRT-12-114, LRT-12-115, LRT-12-119, LRT-12-108
 OEM Vauxhall/Opel: KM-819, KM-826, KM-823, KM-822, KM-811, KM-825, KM-813

Ref.	📦	EAN
11-317	1/2	5907558436204

Zestaw blokad rozrządu

Timing tool set / Nockenwellen-Arretierwerkzeugsatz / Набор фиксаторов распредела для установки фаз ГРМ / Набор стопорів для розподілювальних валів / Vezérműtengely blokkoló készlet / Set de blocarea distribuției / Sada blokovací pro opravu rozvodů / Súprava blokad rozvodov / Set blokad gredi / Paskirstymo velenėlių fiksavimo komplektas / Sadales mehānismu fiksatoru komplekts / Jaotuse blokeerimise komplekt / Комплект блокировки на газораспределении / Set alata za blokiranje radilice / Pribor za blokadu razvodjenja / Σε αποκτάτης κινδικοφόρων αξόνων / Kit de bloqueo de la correa de distribución / Attrezzi di blocco dell'albero a camme / Conjunto de bloqueios de engrenagem de distribuição / Ensemble de verrouillage de distribution / Set van distributievergrendeling



RENAULT: Clio, Clio Sport, Twingo, Kangoo, Megane, Scenic, Laguna, Espace, Safrane, Spider, R19, Master, Trafic
OPEL: Arena, Movano
VOLVO: S40, V40
Gasoline engine: 1.2 / 1.4 / 1.6 / 1.7 / 1.8 / 2.0 / 2.2 / 1.4 16V / 1.6 16V / 1.8 16V / 2.0 16V / 2.5 20V
Diesel Engine: 1.9 / 2.5 / 2.8



Kody silników / Engine codes / Коды двигателя:
B16, B18, B20, N7Q, N7U, K4J, K4M, F4P, F4R, D7F, E5F, E7F, E7J, K7M, F1N, F3N, F3P, F2R, F3R, F7P, F7R, J5R, J7R, J5T, F8M, F8Q, G8T, J8S, F9Q, S8U, S9U, S9W
OEM: MOT1348 | MOT1312 | MOT1135-01 | MOT1384 | MOT1337 | MOT1496 | MOT910-1 | MOT910 | MOT861 | MOT863 | MOT1054 | MOT1318 | MOT1489 | MOT1340 | MOT1386 | MOT1490-1

Ref.	📦	EAN
11-322	1/4	5907558436235



FIAT Ducato, IVECO Daily 2002-2009
CITROEN Relay, Jumper III 2006-2009
PEUGEOT Boxer III 2006-2009



Silniki / Engines / Двигатели:
2.3 JTD - F1AED481C, F1AED481D, F1AED481N,
3.0 JTD - F1CED481D (2004-)
3.0HDI - F30DT
OEM: 99360614(-), 0191/2.B, 99360615/2.000.018.200(-), 191/2.A,
99360608/1.860.617.000

Ref.	📦	EAN
11-325	8/32	5907558436266



FIAT: Bravo/Brava, Barchetta, Coupe, Doblo Cargo, Idea, Marea/Weekend, Multipla, Siena, Palio/Weekend, Punto, Stilo
Silniki benzynowe / Gasoline engine / Бензиновый двигатель:
1.2; 1.4; 1.6; 1.8 16V
Bravo/Brava, Cargo, Doblo, Ducato, Marea/Weekend, Multipla, Palio/Weekend, Punto, Scudo, Stilo, Ulisse, Dukato, Cromia itd



Silniki diesla / Diesel engine / Дизельный двигатель:
1.9D, 1.9TD, 1.9JTD, 2.4TD, 2.4JTD
OEM: 1860847000 | 1860875000 | 1870697000 | 1860895000 | 1895879000 | 1860898000 | 1860992000 | 1860771000 | 1860161000 | 1860874000 | 1860876000 | 1860845000 | 1860876000 | 1860965000 | 1860901000 | 1860905010 | 1860987000 | 1860985000

Ref.	📦	EAN
11-326	1/4	5907558436273

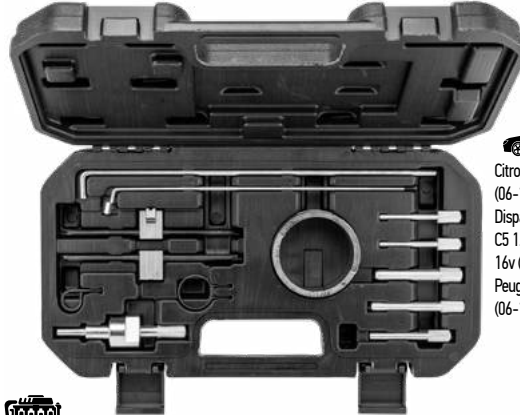

CITROEN: C4 Picasso/Grand Picasso (06-10), C5 II (04-08), C8 (05-10), Dispatch/Jumpy (07-11), Xsara 2.0 16v, C5 1.8/2.0/HPI, Xsara Picasso 1.8/2.0 16v (02-05)
PEUGEOT: 406 1.8 16v (00-04), 407 (06-10), 807 2.0 16v (02-05)



Kody silników / Engine codes / Коды двигателя:
1.8 16v: EW7A(6FY)
2.0 16v: EW10A(RFJ), EW10ABE4(RFH), EW10J4S(RFK)
OEM: 0189S1, 0189S2, 0132AB / 0194A/0178D, 0194B, 0188M, 0189B, 0188AH, 0189R, 7017TR / 0153U, 0188J2, 0188J/J2, 0178E / 571ITE

Ref.	📦	EAN
11-321	1/4	5907558436228



FIAT: Panda, Idea, Doblo
OPEL: Agila, Corsa, Astra H, Tigra B, Meriva
ALFA ROMEO: 147, 156
OPEL: Astra, Vectra, Signum, Zafira



Silniki / Engines / Двигатели:
1,3 JTD MULTIJET (04-07)
1,3 CDTI (04-07)
1,9/2,4 JTD, 16V, 20V
1,9 JTD 16V/2,4 JTD 20V
1,9 CDTI (04-06)
1,7D / 1,9 D FIAT / TD / JTD 2,4

Ref.	📦	EAN
11-323	1/4	5907558436242



ALFA ROMEO: Mito (10-15)
FIAT: 500 (07-15), 500C (07-15), Doblo/Cargo (05-10), Fiorino (09-15), Grande Punto (07-12), Idea (05-12), Linea (07-11), Panda/Panda Classic (09-13), Panda EVO2 (05-12), Punto EVO (09-12), Punto (12-15), Qubo (09-15), Seicento/600 (00-11)
FORD: Ka (09-15)
LANCIA: Musa (05-13), Ypsilon (06-15)



Kody silników / Engine codes / Коды двигателя:
Fiat: 1.1 8v; 187A1.000, 1.2/1.2 Dualogic; 169A4.000, 188A4.000 (EVO2 only), 199A4.000, 1.4/1.4 Bi-Fuel LPG/1.4 Natural Power CNG; 199A7.000, 350A1.000
Ford: 1.2 Duratec; 169A4.000(FP4)
Lancia: 1.2 8v; 188A4.000, 1.4/1.4 Bi-Fuel LPG; 350A1.000
OEM Ford: 303-1477 | 303-1478 | 303-1480 | 303-1479
OEM Fiat: 2000004200 | 2190754200 | 2000004300 | 2000004400 | 2190754400 | 2191964400 | 2000004500 | 2190754500 | 2191964500 | 1860987000

Ref.	📦	EAN
11-324	1/5	5907558436259

Zestaw blokad rozrządu

Timing tool set / Nockenwellen-Arretierwerkzeugsatz / Набор фиксаторов распределителя для установки фаз ГРМ / Набор стопорів для розподільвальних валів / Vezérműtengely blokkoló készlet / Set de blocarea distribuției / Sada blokovací pro opravu rozvodů / Súprava blokad rozvodov / Set blokad gredi / Paskirstymo velenėlių fiksavimo komplektas / Sadales mehānismu fiksatoru komplekts / Jautuse blokeerimise komplekt / Комплект блокировки на газораспределителе / Set alata za blokiranje radilice / Pribor za blokadu razvođenja / Set συγκράτησης κνυδακοφόρων αξόνων / Kit de bloqueo de la correa de distribución / Attrezzi di blocco dell'albero a camme / Conjunto de bloqueios de engranagem de distribuição / Ensemble de verrouillage de distribution / Set van distributievergrendeling



OPEL:
Astra, Vectra B/C, Zafira, Signum,
Frontera
Silnik benzynowy/Gasoline engine:
2.2 16V



Kody silników / Engine codes / Коды двигателя:
Z22SE, Z22YH

Ref.	📦	EAN
11-331	1/5	5907558436297

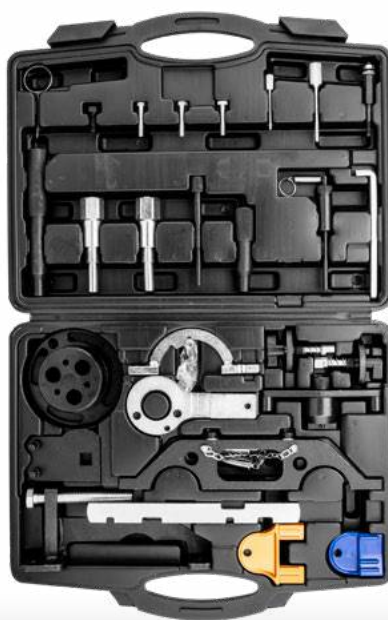

OPEL:
AGILA, ASTRA, CORSA, FRONTERA, OMEGA,
SINTRA, VECTRA, TIGRA, ZAFIRA, (SAAB,
RENAULT)



Silniki diesla / Diesel engine / Дизельный двигатель:
1.3CDTI 16V, 1.9CDTI, 2.0 Dti, 2.2DTI
OEM: KM-952/09912-38310, KM-953/09919-58310, KM-954/09919-08310, KM-955/09919-58320, KM-6130

Ref.	📦	EAN
11-330	1/2	5907558436280



FORD:
Focus, C-Max, Mondeo (2003-2010)



MAZDA: 1.4 1.8 2.0 2.4 2.5 TDCi,
TD, Di, SCI
FORD: Fiesta, Courier, Escort, Orion,
Sierra, Mondeo, Focus, Transit,
Tourneo, Fusion.



Silniki benzynowe / Gasoline engine / Бензиновый двигатель: 1.6 16V
Kody silników / Engine codes / Коды двигателя: HXDA (2003-2007), HXJA, PNBA, RHBA,
Silniki diesla / Diesel engine / Дизельный двигатель: 2.0 TDCi
Kody silników / Engine codes / Коды двигателя: G6DA, G6DB, G6DC (2003-2007)
OEM Ford: 303-1097 | 303-1054 | 303-1059 | 303-1270 | 303-748 | 303-735 | 303-1277 | 21-259 | 21-263
OEM Peugeot: 0188X | 0187B | 0189B | 0188M | 0194B | 0132AJ1
OEM Citroen: 0188X | 0187B | 0189B | 0188M | 0194B | 0132AJ1
OEM Renault: MOT1430
OEM Volvo: 9997121 | 9997152 | 9997122

Ref.	📦	EAN
11-335	1/10	5907558436334



Chrysler Voyager (2001-2008)
Chrysler Grand Voyager (2001-2008)
Jeep Cherokee (2001-2008)
LDV Maxus (2005-2008)



Kody silników / Engine codes / Коды двигателя:
R2516C, R2516L, R2816K, VM2516L
OEM: VM1052 | VM9660 | VM8873 | VM1080 | VM1068 | VM1089 | VM1053
Chrysler

Ref.	📦	EAN
11-332	1/10	5907558436303



FORD:
Galaxy, Mondeo, S-Max, Focus 2010-



Silniki benzynowe / Gasoline engine / Бензиновый двигатель:
2.0 SCTI EcoBoost/Ti-VCT
Kody silników / Engine codes / Коды двигателя:
TNWA / TNWB / TNBA / TPWA / MGDA / XQDA
OEM: 303-748 | 303-1504 | 303-1565 | 303-1521

Ref.	📦	EAN
11-336	1/5	5907558436341

Zestaw blokad rozrządu

Timing tool set / Nockenwellen-Arretierwerkzeugsatz / Набор фиксаторов распревала для установки фаз ГРМ / Набор стопорів для розподільвальних валів / Vezérműtengely blokkoló készlet / Set de blocarea distribuției / Sada blokovací pro opravy rozvodů / Súprava blokad rozvodov / Set blokad gredi / Paskirstymo velenėlių fiksavimo komplektas / Sadales mehānismu fiksatoru komplekts / Jaotuse blokeerimise komplekt / Комплект блокировки на газораспределении / Set alata za blokiranje radilice / Pribor za blokadu razvodenja / Σετ συγκράτησης κωδικοφόρων αξόνων / Kit de bloqueo de la correa de distribución / Attrezzi di blocco dell'albero a camme / Conjunto de bloqueios de engrenagem de distribuição / Ensemble de verrouillage de distribution / Set van distributievergrendeling



FORD/CITROEN
FIAT/JAGUAR
LAND ROVER
LDV/PEUGEOT



Ford: Mondeo (00-07), Transit (00-14)
Citroen: Relay/Jumper III (06-13)
Fiat: Ducato (06-11) : Ducato (06-11)
Jaguar: X-Type (03-10)
Land Rover: Defender Td4 (06-11)
LDV: Convoy (02-06)
Peugeot: Boxer III (06-12)



Kody silników / Engine codes / Коды двигателя:

2.0D Di/TDi/TDCi: ABFA, D3FA, F3FA, D5BA, D6BA, F1FA, FMBA, FMBB, HJBA, HJBB, HJBC, HJBE, N7BA, N7BB
2.2D TDCi/ECOnetic: BG, CYFA, CYFB, CYFC, DRFA, DRFB, DRFC, P8FA, P8FB, PGFA, PGFB, QJBA, QJBA (BG), QJBB, QJBC, QJBD, QVFA, QWFA, SRFA, SRFB, SRFC, SRFD, SRFE, UHFA

2.2D HDi/JTD:

P22DTE (4HM), P22DTE (4HU), P22DTE (4HV)

2.4D Di/TDCi: D0FA, D2FA, D2FB, D4FA, F4FA, FXFA, H9FA, H9FB, H9FD, JXFA, JXFC, PHFA, PHFC

2.4D TD/Tdi:

ZSD 424

2.4D Td4; 244DT

OEM: 303-679A/21-238, 303-1151, 303-698/21-251, 303-675/21-234

Ref.	📦	EAN
11-334	1/5	5907558436327



VOLVO



VOLVO:

Silniki benzynowe/gasoline engine: 4,5,6 cylinder

S80 (07-), V70 (08-), S80 (-06), XC90, V70 (00-08), V70 XC (01-)/XC70 (-07), S60, C30, C70 (06-), S40 (04-), V50, S40 (-04), V40, 850, C70 Coupe (-05), S70, V70 (-00), V70 XC (-00), 960, S90, V90



Kody silników / Engine codes / Коды двигателя:

B41XX, B42XX, B52XX, B62XX, B63XX, GB5252S

Ref.	📦	EAN
11-337	1/2	5907558436358

Ściągacz uniwersalny

Universal pulley puller / Universalabzieher / Универсальный съемник / Знімач універсальний / Univerzális agylehúzó / Extractor universal / Univerzální stahovák / Univerzálny stahovák / Univerzalni izvlekač / Universalus nutrauklis / Universālais novlēcējs / Universaalne tōtmits / Универсален скоба за демонтаж / Univerzalni skidač / Univerzalna alatka za skidanje / Εξολκείας γενικής χρήσης / Extractor universal / Estrattore universale / Extrator universal / Extracteur de poulie universel / Universiele poelietrekker

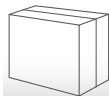

Ref.	📦	EAN
11-299	1/10	5907558436044

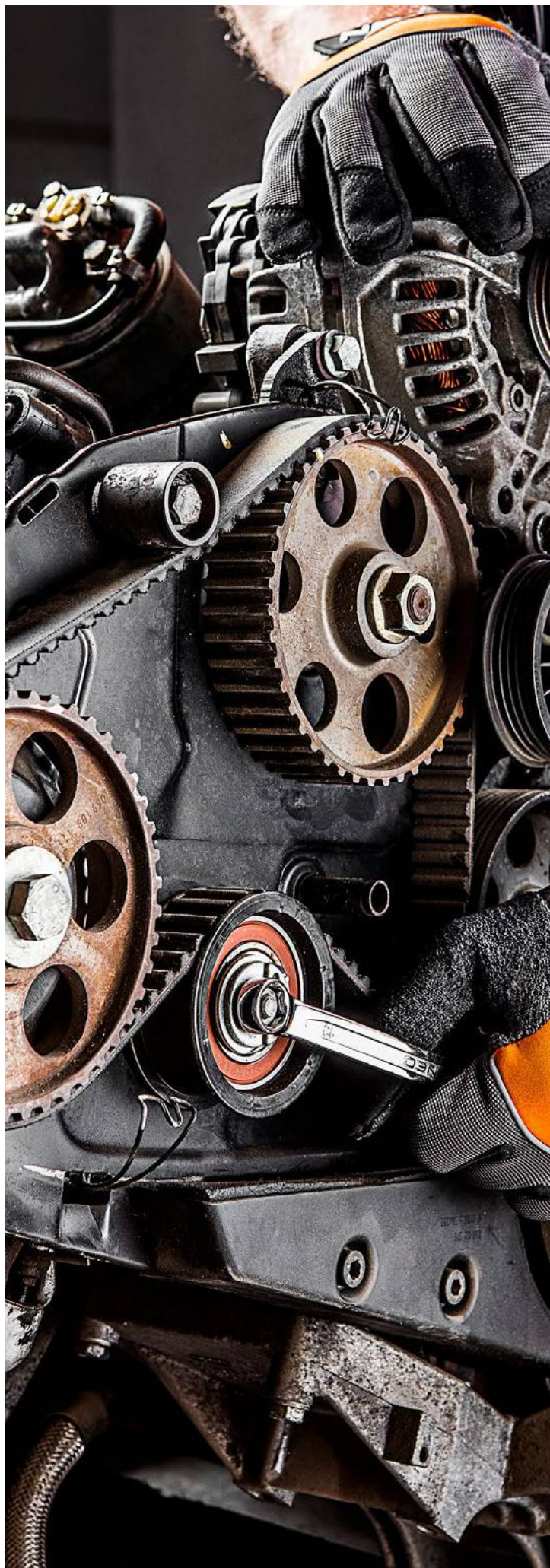

Zestaw blokad rozrządu

Timing tool set / Nockenwellen-Arretierwerkzeugsatz / Набор фиксаторов распределителя для установки фаз ГРМ / Набор стопорів для розподільчальних валів / Vezérműtengely blokkoló készlet / Set de blocarea distribuției / Sada blokovací pro opravu rozvodů / Súprava blokad rozvodov / Set blokad gredi / Paskirstymo velenėlių fiksavimo komplektas / Sadales mehānismu fiksatoru komplekts / Jautuse blokeerimise komplekt / Комплект блокировки на газораспределителе / Set alata za blokiranje radilice / Pribor za blokadu razvodjenja / Set συγκράτησης κνυδακοφόρων αξόνων / Kit de bloqueo de la correa de distribución / Attrezzi di blocco dell'albero a camme / Conjunto de bloqueios de engranagem de distribuição / Ensemble de verrouillage de distribution / Set van distributievergrendeling



Vauxhall/Opel:
Astra H (04-11), Astra J (10-15), Cascada (13-15), Insignia (08-13), Signum (04-08), Vectra C (04-08), Zafira B (05-12), Zafira C Tourer (11-15)

Saab:
9-3 (04-10), 9-5 (05-10)
Fiat: 1.9, 2.4 JTD, 16V, 20V
Alfa Romeo: 147, 156, GT



1.9D CDTi: Z19DT, Z19DTH, Z19DTJ, Z19DTL
1.9D TDi: Z19DT, Z19DTH
1.9D TTDi: Z19DTR
1.9D XTDi: A19DTR, Z19DTR
2.0D CDTi/ecoFLEX: LBQ/A20DTL, LBR/A20DT, LBS/A20DTH, LBX/A20DTJ, LBY/A20DTR, LCD/A20DTC
2.0D TDi: LBS/A20DTH
2.0D TTDi: LBY/A20DTR
1.9 JTD 16V, 2.4 JTD 20V: 192 A5.000, 192 B1.000, 937 A4.000, 937 A5.000; EN46789

Ref.	📦	EAN
11-339	1/10	5906692022175

OPEL
CDTI



OPEL: Astra G (03-10), Astra H (04-13), Astra J (09-15), Corsa D (07-14), Insignia (08-13), Meriva A (04-10), Mokka (12-15), Signum (06-08), Vectra C (06-08), Zafira B (05-14), Zafira C Tourer (11-15)
Alfa Romeo: 159 (05-10)
Chevrolet: Aveo (08-14), Cruze (09-15), Orlando (11-15)
Fiat: Croma (06-11), Stilo (05-08)
Saab: 9-5 (10-12)



1.4 16V: G14D
1.6: A16LEL, A16LER, A16LET, A16XER, LDE/A16LER, LDE/A16XER, LLU/A16LET, Z16LEL, Z16LER, Z16LET, Z16XE1, Z16XEP, Z16XER
1.6 ecoFLEX CNG: A16XNT, LGE/A16XNT, Z16XNT
1.8: 2HO/A18XEL, 2HO/A18XER, A18XER, Z18XER
939A4.000, 939A4.000; 2.000.012.000, 2.000.012.100, 2.000.012.800, EN-6333, EN-6340

Ref.	📦	EAN
11-340	1/10	5906692022182



VW: Fox (05-12), Polo (02-12)
Skoda: Fabia (02-07), Fabia II (07-15), Roomster (06-12), Praktik (09-15), Superb III (10-15)
Seat: Ibiza/Cordoba (02-15)



1.2 6V: AWY, BBM, BMD, CHFA, CHFB
1.2 12V: AZQ, BME (02-07), BXV, BZG, CEVA, CGPA, CGPB, CJLA
VAG: T10120, T10121, T10123

Ref.	📦	EAN
11-341	1/10	5906692022199



Dacia: Logan/MCV (05-11)
Renault: Avantime (00-03), Clio II (99-06), Clio III/Sport (06-09), Espace/Grand Espace (98-02), Espace/Grand Espace IV (02-10), Kangoo/Trekka (01-09), Laguna (98-01), Laguna II (01-07), Laguna III (07-13), Megane (99-03), Megane II (02-10), Megane III/Sport (08-13), Megane/Scenic (99-00), Scenic/RX4 (99-03), Scenic/Grand Scenic II (03-09), Trafic II (01-11), Twingo II (08-14), Vel Satis (00-10), Wind (10-14)
Nissan: Micra, Kubistar X76 (03-09), Primastar (02-11)
Vauxhall/Opel: Vivaro (01-11)



1.4 16V K4J: 730, 732, 740
1.6 16V K4M: 752, 753, 760, 761, 764, 788, 812, 813, 854, 856
1.8 16V F4P: 720, 722, 760, 770, 771, 772, 773, 774, 775
2.0 16V F4R: 700, 701, 712, 713, 714, 715, 720, 722, 730, 732, 736, 738, 740, 741, 744, 746, 747, 762, 763, 764, 765, 766, 767, 770, 771, 780, 790, 791, 792, 820, 830, 832, 867
2.0 16V F4R(i): 720, 722, 764, 765, 774, 776, 784, 786, 787, 794, 795, 796, 797, 800, 802, 810, 811, 870, 872, 874, 886, 887, 896, 897
Renault: Mot1054, Mot1489, Mot1496, D4F, K4J, K4M, F4P, F4R, F4Rt, F5R740, K9K
Nissan: K9K, K4M
Opel: F4R720

Ref.	📦	EAN
11-342	1/10	5906692022205



Citroen: Berlingo III, Berlingo IV, C-Elysee (12-16), C1 II, C3 Aircross, C3 III / C3 Picasso, C3 IV, C4 Cactus, C4 II, C4 Picasso, Grand Picasso II, C4 Space Tourer/Grand Space Tourer, C5 Aircross, DS3 / DS3 Cabrio (12-16), DS4, DS3 Crossback, DS4 Crossback, DS7 Crossback
Peugeot: 108 (14-16), 208 (12-16), 208 II 301 308 (13-16), 508 2008 (13-16) 2008 II 3008 3008 II 5008 5008 II Partner III Partner IV



1.2: IPP (HM01), D12XHL, D12XHT, EB2 (HMT), EB2 (HMW), EB2 EB2ADTS/LEG, EB2DT (HNX), EB2DT (HNZ), EB2DT/LES, EB2DTM (HNW), EB2DTS (HNW), EB2DTS (HNY), EB2DTS/LEG, EB2DTS/LES/B12XHT, EB2DTS (HNX), EB2DTS (HNW), EB2F (HMT), EB2F/LEZ, EB2FA (HMR), EB2FA/LEZ

OEM 0109-2A
OEM 0109-2B
OEM 0109-2C
OEM 0109-2D

Ref.	📦	EAN
11-344	0/5	5907558436877



PETROL
DIESEL



Ref.	📦	EAN
11-343	0/5	5907558436877

Zestaw blokad rozrządu

Timing tool set / Nockenwellen-Arretierwerkzeugsatz / Набор фиксаторов распредела для установки фаз ГРМ / Набор стопорие для розподілювальних валів / Vezérműtengely blokkoló készlet / Set de blocarea distribuției / Sada blokovací pro opravy rozvodů / Súprava blokad rozvodov / Set blokad gredi / Paskirstymo velenėlių fiksavimo komplektas / Sadales mehānismu fiksatoru komplekts / Jaotuse blokeerimise komplekt / Комплект блокировки на газораспределенном / Set alata za blokiranje radilice / Pribor za blokadu razvodjenja / Σετ συγκράτησης κωδικοφόρων αξόνων / Kit de bloqueo de la correa de distribución / Attrezzi di blocco dell'albero a camme / Conjunto de bloqueios de engrenagem de distribuição / Ensemble de verrouillage de distribution / Set van distributievergrendeling



Ford: Mondeo (2016-), S-Max (2016-), Galaxy (2016-), Transit (2016-), Transit Custom (2016-)

EcoBoost, Duratec, Duratorq-TDCi, EcoBlue Diesel
2.0: YWFA, YWFB, YWFC, YTMA, YTMБ, YTMC, ADFF, T8FA, T8FB, T8MC, T8MA, YTFA, YTFB, YTFC

OEM 303-1643, 303-1844, 303-1845



Ref.	📦	EAN
11-345	1/1	5906692022236

Ford: B-Max (12-18), C-Max (12-20), Grand C-Max (17-20), EcoSport (13-25), Fiesta (12-24), Focus (12-20), Mondeo (15-18), Puma (19-20), Transit Courier (14-24), Transit Connect (13-20), Grand Tourneo Connect (13-18), Tourneo Courier (15-24), Tourneo Connect (18-20)

1.0: B7JB, M1DA, M1JA, M1JU, M2DA, M2GA, P4JA, P4JB, SFJA, SFJB, XMJA, XMJB, XPJA, XPJB, XPJC, XPJD, XYJA, XYJB, XYJC, XYJD, XYJE, Y7JB, YYJA, YYJB, YYJC, YYJD, YYJE, YYJF, YYJG
OEM 303-1605/1
OEM 303-1605/2
OEM 303-1602
OEM 303-1604
OEM 303-1606/1
OEM 303-1606/2
OEM 303-732
OEM 303-1054



Ref.	📦	EAN
11-346	1/5	5906692022243



Ford: Fiesta (19-24), Focus (18-25), C-Max (18-22), Grand C-Max (18-22), Puma (19-25)

1.0: B7DA, B7DC, B7JA, B7JB, B7JC, MOJA, MOJB, MODC

OEM Ford: 303-1661/1
303-1661/2
303-1661/3
303-1603
303-1643
310-018
303-1604
0132-AB
23-019



Ref.	📦	EAN
11-347	1/5	5906692022250

Nasadki do sondy lambda i wtryskiwaczy

Oxygen sensor and fuel injectors wrench set / Aufsätze für lambda-sonden und einspritzdüsen / Набор насадок для лямбда-зонды и форсунок / Насадки до лямбда-зонды і форсунок / Injektor és lambdaszonda szerelő készlet / Ajutaj pentru sonda lambda și injectoare / Ключи на лямбда сонды а встřиковачи trysky / Nástavce na lambda sondu a vstrekovače / Nasadni ključići za sondu lambda in injektorji / Galvučij rinkinys liambda zondui ir purkštukams / Lambda zondes un sprauslu uzgāļi / Lambda sondi otsakud ja pihustid / Накрайніци за лямбда сонды и за инжектору / Nasadni ključevići za lambda sondu ubrizgivača / Nastavci za sondu lambda i brizgalice / Σετ καρδιάκια και ακροφύσια για αισθητήρα λάμδα και εγχυτήρες / Casquillos para sonda lambda y para inyector / Bussolle per sonda lambda e iniettori / Bocais para a sonda lambda e injetores / Douilles pour sondes lambda et injecteurs / Doppen voor lambdasonde en inspuiters



- 78 mm x 17, 19, 27, 28, 30 mm
- 80 mm x 27 mm
- 85 mm x 21 mm
- 90 mm x 22 mm
- 110 mm x 27 mm

Nasadka sześciokątna 1/2" do sondy lambda / 6 point socket 1/2" for oxygen sensors / Головка 6-гранная 1/2" для лямбда-зонды

Nasadki odgięte do sondy lambda / Offset sockets for oxygen sensors / Головка для лямбда-зонды

- 80 mm x 20 mm

Nasadki dwunastokątna 1/2" do wtryskiwaczy / 12 point sockets 1/2" for diesel injectors / Головки 12-гранные для форсунок

- 110 mm x 22 mm

- 150 mm x 22 mm

Ref.	📦	EAN
11-880	0/5	5907558436877



Nasadki dwunastokątna 1/2" do sondy lambda / 12 point sockets 1/2" for oxygen sensors / Головки 12-гранные для лямбда-зонды

- 78 mm x 22, 28 mm

- 80 mm x 27 mm

Nasadka sześciokątna 1/2" do sondy lambda / 6 point socket 1/2" for oxygen sensors / Головка 6-гранная 1/2" для лямбда-зонды

- 90 mm x 29 mm

Nasadki sześciokątna 3/8" do sondy lambda / 6 point sockets 3/8" for oxygen sensors / Головка 6-гранная 3/8" для лямбда-зонды

- 74 mm x 27 mm

- 80 mm x 22 mm

- 90 mm x 22 mm

Odgięte nasadki do sondy lambda / Offset sockets for oxygen sensors / Головка для лямбда-зонды

- 31 mm x 22 mm x 3/8"

- 50 mm x 22 mm x 1/2"

Nasadka dwunastokątna 1/2" do wtryskiwaczy / 12 point socket 1/2" for diesel injectors / Головка 12-гранная 1/2" для форсунок

- 108 mm x 22 mm

Ref.	📦	EAN
11-882	0/5	5907558436891

Klucze nasadowe do sondy lambda

Oxygen sensor socket wrench / Aufsatzschlüssel für lambda-sonde / Торцевые головки для лямбда-зонды / Ключи торцевые до лямбда-зонды / Lambdaszonda szerelő készlet / Chei tubulare pentru sonda lambda / Nástrčné klúčě pro sondu lambda / Nástavcové klúčě na lambda sondu / Nasadni ključići za sondu lambda / Galvutės liambda zondui / Mucignatslēgas lambda zondei / Lambda sondi vādi / Ключови накрайніци за лямбда сонды / Nasadni ključevići za lambda sondu / Ključ natikač za sonde lambda / Καρδιάκια για αισθητήρα λάμδα / Llave de vaso para sonda lambda / Set di bussolle per sonda lambda / Chaves articuladas para a sonda lambda / Clé à sonde lambda / Dopsleutels voor lambdasonde



- 1/2" x 29 x 90 mm (wycięcie 8 mm)
- 1/2" x 27 x 80 mm
- 3/8" x 7/8" x 90 mm (wycięcie 20 mm)
- 3/8" x 1-1/16" x 74 mm
- 3/8" x 7/8" x 80 mm
- 1/2" x 22 x 50 mm
- 3/8" x 22 x 31 mm

Ref.	📦	EAN
11-881	0/10	5907558436884

Klucze nasadowe do sondy lambda

Oxygen sensor socket wrench / Aufsatzschlüssel für lambda-sonde / Торцевые головки для лямбда-зонда / Ключи торцевые до лямбда-зонды / Lambdasonda kulcs készlet / Cheie tubulare pentru sonda lambda / Nástrčné kľúče pro sondy lambda / Nástavcové kľúče na lambda sondu / Nasadni ključiči za sondo lambda / Galvutės liambda zondui / Muciņatslēgas lambda zondei / Lambda sondi vāti / Ключови накрайници за лямбда сонда / Nasadni ključeviči za lambda sondu / Ključ natikač za sonde lambda / Καρδιάκια για αισθητήρα λямбδα / Llave de vaso para sonda lambda / Set di bussole per sonda Lambda / Chaves articuladas para a sonda lambda / Clé à sonde lambda / Dopsleutels voor lambdasonde

Otkienka w nasadkach pozwalają na montaż bez demontażu przewodów
Nasadki pasują do popularnych aut osobowych poruszających się po europejskich drogach
Open-sided for lambda probe fitting without the removal of cables
The sockets fit popular European cars
Дірочки в голівках дозволяють проводити монтаж без демонтажу проводів
Голівки підійдуть популярним легковим автомобілям на європейських дорогах

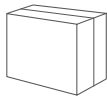

Nasadka końcowej sondy lambda (gorącej) / The socket for end lambda probes (hot) / Голівка для кінцевих лямбда-зондів (гаряча) 1/2", 22 mm x 50 mm
Nasadka czujnika podciśnienia i sondy lambda (do sond nisko osadzonych) / The socket for end lambda probes (hot) / Голівка вакуумного датчика і лямбда-зондів (для низько посаджених зондів) 3/8", 22 mm x 30 mm
Nasadka czujnika podciśnienia i sondy lambda / The socket for vacuum sensor and lambda probe / Голівка вакуумного датчика і лямбда-зондів 3/8", 22 mm x 80mm

Ref.	⊠	EAN
11-203	0/20	5907558416763

Klucz do sondy lambda

Oxygen sensor socket wrench / Schlüssel für lambda-sonde / Ключ для лямбда-зонда / Ключ до лямбда-зонды / Lambdasonda kulcs, rövid / Cheie pentru sonda lambda / Kľúč na lambda sondu / Kľúč na lambda sondu / Ključ za sondo lambda / Raktas liambda zondui / Lambda zondes atslēga / Lambda sondi vāti / Ключ за лямбда сонда / Ključ za lambda sondu / Ključ za sondo lambda / Клейди αισθητήρα λямбδα / Llave para sonda lambda / Set di bussole per sonda Lambda / Chave para a sonda lambda / Clé à sonde lambda / Sleutel voor lambdasonde

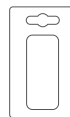

Nasadka do długich sond lambda i tam gdzie złącze przewodów nie pozwala na zastosowanie typowej nasadki do sond z szczeliną
The socket is suitable for long lambda probes and wherever cable connectors do not allow for using typical probe sockets with a gap
Голівка для довгих лямбда-зондів і там, де кабельний роз'єм не дозволяє використовувати типову голівку для лямбда-зондів з зазором

Ref.	W [mm]	⊠	EAN
11-204	22	10/100	5907558416749



Nasadka do krótkich sond lambda
The socket is suitable for short lambda probes
Голівка для коротких лямбда-зондів

Ref.	W [mm]	⊠	EAN
11-205	22	10/50	5907558416756

Ściągacze do wtrysków z młotkiem bezwładnościowym

Fuel injector extractor service set / Abzieher für Einspritzungen mit Trägheitshammer / Комплект для снятия дизельных форсунок с обратными молотками / Комплект знімання форсунок зі зворотним молотками / Befestendezőjei kihűző készlet csúszó kalapáccsal / Instalații de decapare pentru injectări cu ciocan inertial / Sada na vstříkovače s reverzním kladivem / Sítahováký vstrekačov so zotravným kladivom / Izvlekači za injektorje z inercijskim kladivom / Dizelinių purkštukų nuėmimo kompletas su atbuliniu plaktuku / Dizela sprauslu noņēmēju komplekts ar inercēs āmuru / Kütuseihusti tõmmitsad, inertshaamriga / Инструмент сноба обратен чука за вадене на дюзи / Skidači za ubrizgivače s inercijskim čekićem / Komplet alatki za skidanje mlaznica sa inercijalnim čekićem / Σετ εξαγωγής ακροφυσίων εγχυτήρα ντιζέλ με σφυριά ολιθησης, κεφαλές / Extractores para inyección con martillo de inercia / Estrattori per iniettori con martello inerziale / Fresas para limpeza de encaixes de injetores / Kit extracteur injection diesel avec marteau coulissant / Injectietrekkers met glijhamer

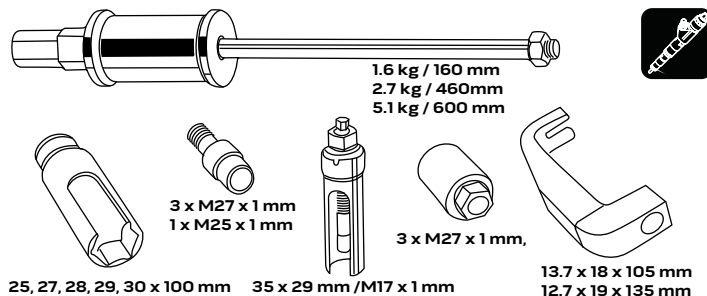
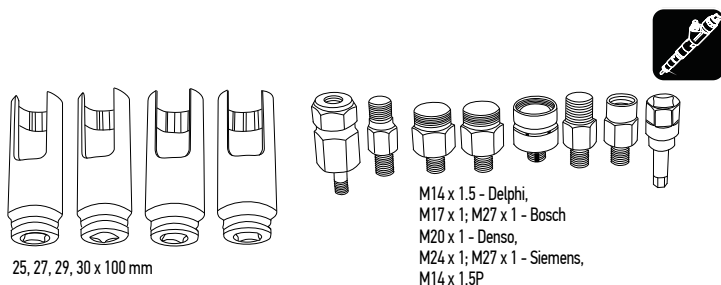

Ref.	⊠	EAN
11-883	1/2	5907558435405



Ref.	⊠	EAN
11-884	1/1	5907558435412

Frezy do czyszczenia gniazd wtryskiwaczy

Diesel injector seat cleaning / Fräsen zur Reinigung von Einspritzungsbuchsen / Набор для чистки посадочных мест дизельных форсунок / Набор для чищення посадкових місць дизельних форсунок / Injektor fészek taró és tisztító készlet / Freze pentru curățarea prizelor injectoarelor / Frézy na čištění sedel vstřikovačů / Frézy na čistenie zásuviek vstrekačov / Orodje za čiščenje ležišč injektorjev / Dyzelinij purkštukų lizdų valymo įrankių rinkinys / Dizeļa sprauslu ligzdu tīrītāji / Pihustipesade puhastamise freesid / Фрезы за почистване на леглото на инжектору / Set za čiščenje priključka ubrizgivača / Pribor za čiščenje utičnica ubrizgivača / Set кавариаρού υποδοχών ακροφυσίων εγχυτήρα ντιζελ / Fresas para la limpieza de las tomas de los inyectores / Frese per la pulizia delle sedi degli iniettori / Fresas para limpeza de encaixes de injectores / Kit de nettoyage pour sièges d'injecteurs / Freesstukken voor reiniging van injectie nesten

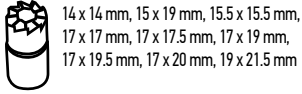

14 x 14 mm, 15 x 19 mm, 15.5 x 15.5 mm,
17 x 17 mm, 17 x 17.5 mm, 17 x 19 mm,
17 x 19.5 mm, 17 x 20 mm, 19 x 21.5 mm



15.5 x 15.5 mm, 17 x 17 mm,
17 x 21 mm, 17.5 x 20.5 mm



Ref.	📦	EAN
11-885	1/5	5907558435429

Zestaw do centrowania tarcz sprzęgła

Clutch center set / Zentriersatz für Kupplungsscheiben / Универсальный набор для центровки дисков сцепления / Набор універсальний для центрування дисків зчеплення / Kupplungtárcsa központosító készlet / Trusa de centrare a discurilor de ambreiaj / Sada pro centrování spojkových kotoučů / Centrovacia súprava kotúčov spojky / Kľuč za centriranje plošč sklopke / Sankabos diskų centravimo rinkinys / Sajūga disku centrēšanas instrumentu universālais komplekts / Siduriketaste tsentreerimise komplekt / Комплект за центровка на съединителу / Set za centriranje ploča spojke / Pribor za centriranje diskova kvačila / Set κεντραρισματος δίσκων συμπλέκτη / Kit de centrado de la placa de embrague / Kit per il centraggio del disco frizione / Kit de centrage de discos de embraigem / Kit de centrage pour disques d'embrayage

11, 12, 15, 17, 19, 20, 21, 25 mm



Ref.	📦	EAN
11-170	1/10	5907558437348



Frez do gniazd zaworowych diesel. Zawartość: frez 15 mm płaski frez uniwersalny, 17 mm frez płaski dla wtryskiwaczy, Delphi/Bosch (BMW/PSA/Renault/Ford), 19 mm Frez płaski dla wtryskiwaczy Bosch (Mercedes CRD), 19 mm Frez kątowy do wtryskiwaczy Fiat/Iveco, Trzpień pilotujący 19 mm HEX

Diesel injector seat cutter set 4 pcs. Edge trimming cutter 15 mm flat, universal, 17 mm flat for Delphi/Bosh injectors (BMW/PSA/RENAULT/FORD), 19 mm flat for Bosh injectors (Mercedes CRD), 19 mm angle edge trimming cutter for FIAT/IVECO, Pilot mandrel 19 mm HEX

Фреза для чистки седел дизельных форсунок. В комплекте: плоская фреза 15 мм - универсальное применение, 17 мм плоская фреза для Delphi/Bosch (BMW/PSA/Renault/Ford), 19 мм плоская фреза для Bosch (Mercedes CRD), 19 мм угловая фреза для Fiat/Iveco, держатель - направляющая 19 мм HEX

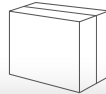

Ref.	📦	EAN
11-218	0/20	5907558420401

Ściągacz do sprzęgieł skrzyń DCT

DCT Clutch Tool / Abzieher für Doppelkupplungsgetriebe / Съемник для сцепления в коробках передач DCT / Знімач до зчеплення у коробках передач DCT / DCT váltó kuplung leszedő szerszám / Strângere pentru ambreiajele DCT / Přípravek na montáž a demontáž spojky k DCT převodovce / Sťahovák pre spojky DCT / Orodje za sklopke DCT / Sankabos diskų nuėmimo įrankis DCT / Ford/Volvo DCT átrumkárbu sajūga noėmėjs / DCT-kasti sidurite tõtmits / Специализиран инструмент за монтаж/демонтаж на DCT съединителу / Alat za skidanje spojki kovčega DCT / Alatka za izvlačenje kutije kvačila DTC / Εργαλείο ξεμονταρίσματος συμπλέκτη στο κιβώτιο ταχυτήτων / Tirador para embragues DCT / Estrattore frizione per cambio DCT - Ford/Volvo / Extrator de embraiagens das caixas DCT / DCT outil d'embrayage / Kraag voor DCT koppeling



Volvo: C30, C70 (06>), S40 (04>), S60 (11>), S80(07>), S80L, V40 (13>), V40 Cross Country, V50, V60, V70(08>), XC60 Ford: Focus(04>), C-Max, S-Max, Galaxy, Mondeo (07>), Kuga (13>), zamiennik / replacement / заміна OEM: Volvo 9997435, Ford 308-763



Ref.	📦	EAN
11-171	1/4	5907558437379

Szczypce do opasek

Clamp pliers / Zange für Kraftstoffleitungen / Щипцы для хомутів / Щипцы для шлангов / Bilincsfogó / Clește / Kleště na spony / Kliešte na hadicové spony / Klešče za vzmetne objemke / Replės žarnelių žiedų užspaudimui / Savilcēju kņables / Kaablisidemet tangid / Щипцы за проводниці на горючото / kliešta za stiskanje / Klešta za žicu / Λαβίδια στεφανίων στερέωσης / Alicates para bridas / Pinza per morsetti in gomma / Pinças para abraçadeiras / Pince de serrage

Do opasek sprężynujących na przewodach olejowych i wodnych etc.
Do pracy w miejscach trudnodostępnych
Długość giętkiej części: 630 mm, długość części z rękojmią: 210 mm
Zasięg ścisiku: 0 – 45 mm

For spring clips on oil and water hoses
For difficult to reach places
Flexible section length: 630 mm, handle section length: 210 mm
Clamping range: 0 – 45 mm

Для пружинних хомутів паливних, масляних і водяних шлангів і т.д.
Для роботи у важкодоступних місцях
Довжина гнучкої деталі: 630 мм, довжина деталі з рукою: 210 мм
Діапазон затиску: 0 – 45 мм



Ref.	W [mm]	☒	EAN
11-221	840	6/36	5907558416602

25 years
GUARANTEE



25 years
GUARANTEE



Ref.	☒	EAN
11-222	0/54	5907558418545



Ref.	☒	EAN
11-223	6/48	5907558418552

Szczypce zaciskowe z tworzywa

Flexible line clamp / Gripzange aus Kunststoff / Набор зажимов с фиксатором / Кліпці довільні пластикуві / Ōnzáró fogókészlet műanyag / Clește de strângere din plastic / Plastové svěrací kleště / Zvieracie plastové kliešte / Plastične klešče za prešcip cevi / Replės stabdžių slangelėms užspausti / Plastmasas saspiešanas kņables / Plastist lukustustangid / Стягаючи кліпси от пластмаса / Stezna kliešta od umjetnog materijala / Plastična klešta / Σετ σφυγκτήρες με μηχανισμό ασφάλισης / Tenazas abraçaderas de plástico / Pinza occlusionie tubu in plastica / Pinças de plástico / Pince de serrage en plastique / Krimptang van kunststof



x3



Ref.	☒	EAN
11-224	0/48	5907558418699



25 years
GUARANTEE

x9

Ref.	☒	EAN
11-228	1/5	5907558437386



CrV
steel

CLIC-R

175
mm

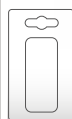

Ref.	☒	EAN
11-226	6/60	5907558420197

Zestaw mini szczypiec do pierścieni osadczych

Mini pliers set for circlips / Mini-Zangenset für Stellringe / Набор щипцов для стопорных колец, "mini" / Набор мініщипців до стопорних кільць / Mini pliers set for circlips / Garnitura de mini clești pentru inele de strangere / Sada precizních kleští na pojistné kroužky / Súprava mini kleští na poistné krúžky / Set mini klešč za objemke / Mini replių komplektas, fiksavimo žiedams / Sprostgredzenu kņabļu komplekts, mini / Lukustusrõngaste minitangide komplekt / Комплект мини щипцы за стопорни пръстени / Set mini seger kliešta za stiskanje i širenje / Komplet mini klešta za taložne prstene / Σετ μικρες λαβίδες για δακτύλια ασφαλείας / Juego de mini alicates para anillos de retención / Kit mini pinze per anelli d'arresto / Pinças para anéis / Jeu de mini-pinces pour colliers de fixation / Set van mini tangen voor dopringen



Ref.	☒	EAN
11-227	24/48	5907558420395

Zaciskacz do pierścieni

Piston ring compressor / Ringklemme / Оправка поршневых колец / Затискач до кілець / Dugattyúgyűrű szerítő szalag / Strängåtor de inele / Svērka na kroužky / Pás na stáňovanie piestnych kružkov / Obročni prižemnik / Žedý suspaudejás / Gredzenu saspiedějs / Vörusulgur / Стяга за пръстени / Stezaljka za prstenje / Stezač za prsten / Συμπιεστής δακτυλίων εμπόλου / Compresor para anillos / Morsetto per anelli / Fixador de anéis / Colier de serrage / Ringklem

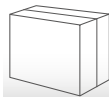
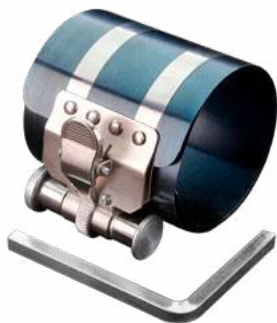

Ref.	Ra [mm]	☒	EAN
11-250	50 - 125	0/60	5907558418330

Klucz do demontażu napinaczy z wymiennymi końcówkami

Tensioner pulley / Schlüssel zum Abbau von Spannern mit auswechselbaren Spitzen / Ключ для снятия переднатяжителей со сменными наконечниками / Ключ для зняття переднатягачів зі змінними наконечниками / Feszítőgörgő kulcs cserélhető fejekkel / Cheia pentru demontarea întinzătoarelor cu capete interschimbabile / Klíč na demontáž napínací kladky s vyměnitelnými koncovkami / Klúč na odstránovanie napínačov s vymeniteľnými hrotmi / Kľuč za odstránitev zategovalnikov z izmenljivimi konicami / Raktas įtempiklių nuėmimui, su keičiamais antgaliais / Priekšspriegotāja demontāžas atslēga ar maiņas uzgaļiem / Pingutite eemaldamise võti, vahetatavate otsakutega / Ключ за демонтиране на обтяжени ролки със сменяеми накрайници / Kľuč za demontažu zatezača sa izmenjivim nastavcima / Kľuč za demontiranje zatezača sa promenljivim krajevima / Κλειδί αφάιρεσης προεντατήρων με ανταλλακτικές μύτες / Llave para quitar los tensores con puntas intercambiables / Chiave per smontaggio dei tenditori con punte intercambiabili / Chave para desmontar tensores com pontas substituíveis / Clé de démontage des détracteurs avec embouts interchangeables / Sleutel voor demontage van spanners met eindstukken

12, 13, 14, 15, 16, 17, 18, 19 mm

E10, E12, E14, E16, E18



Ref.	☒	EAN
11-169	0/10	5907558437331

Klucz do napinania pasków klinowych

Transmission belt tensioning wrench / Schlüssel zum Spannen von V-Spanngurten / Ключ для затягування клинових ремней / Cheia pentru strângerea curelei trapezoidale / Klíč k napínání řemenice / Klúč na utáňovanie klinových remeňov / Kľuč za napenjanje klinastega jermena / Pleištnijū diržų užveržimo raktas / Transmisijas siksnas pievilksanas atslēga / Kiltirihmade pingutamise võti / Инструмент за натягане на клинов ремьн / Kľuč za naprezanje remena / Kľuč za zatezanje klinastih remenova / Κλειδί τάσης σφηνοειδών μιάτων / Llave para apretar las correas / Chiave per il tensionamento di cinghie dentate / Chave para tensionar correias / Clé pour tendre des courroies / Spanner voor V-snaar



Ref.	☒	EAN
11-168	1/6	5907558437324

Zestaw do alternatora

Combined sockets for alternator / Lichtmaschinen-Schlüsselsatz / Набор для альтернатора / Набор до генератора змінного струму / Készlet generátor szereléshez / Set de alternator / Sada na alternátory / Súprava pre alternátor / Set za alternator / Rinkiny's kintamosios srovės generatoriui / Maiņstrāvas ģeneratora instrumentu komplekts / Generaatori padrunvõtmete komplekt / Комплект за алтернатора / Garnitura za alternator / Garnitura za alternator / Σετ για εναλλακτήρα / Juego para alternador / Kit per montaggio e smontaggio alternatori / Jogo de acessórios para alternador / Kit d'alternateur / Set voor wisselstroomgenerator

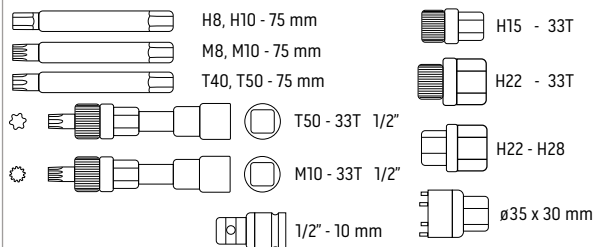

Ref.	☒	EAN
11-167	1/10	5907558437317

Zestaw do układów cieśnienia/podciśnienia

Tester for vacuum and pressure systems / Satz für Druck-/Vakuumsysteme / Набор для напорных / вакуумных систем / Набор для напірних/вакуумних систем / Vákuum és nyomás tesztelő / Set pentru sisteme de presiune / vid / Tester pro tlakové/podtlakové systémy / Súprava pre tlakové / podtlakové systémy / Set za vakuumске in tlačne sisteme / Rinkiny's slėgio / vakuumo sistemoms / Spiediena/ vakuuma sistēmu instrumentu komplekts / Rõhu-/vaakumsüsteemide komplekt / Помпа за тестване на вакуум и налягане / Set za sustave tlaka/ podtlaka / Pribor za sistem pritiska/vakuuma / Σετ για συστήματα κενού αέρος/παροχής υπό πίεση / Probador de sistemas de presión / vacío / Kit per impianti a pressione/in depressione / Kit para sistemas de pressão/ subpressão / Testeur de pression / compression / Meter voor druk/onderdruk systemen



Ref.	☒	EAN
11-267	1/10	5907558436013

Zestaw do diagnostyki systemów Common Rail

Common Rail diagnostic set / Diagnosissatz für Common-Rail-Systeme / Набор для диагностики систем Common Rail / Набор для диагностики систем комон-рэйл / Common rail rendszer diagnosztikai készlet / Trusť pre diagnostickarea sistemelor Common Rail / Sada pro diagnostiku systémů Common Rail / Sada pre diagnostiku systémov Common Rail / Diagnostikos rinkinys, skirtas sistemai Common Rail / Common Rail sistemu diagnosticēšanas komplekts / Common Rail sūsteemide diagnostikakomplekt / Комплект за диагностика на системи Common Rail / Set za dijagnostiku sustava Common Rail / Pribor za dijagnostiku sistema Common Rail / Διαγνωστικό σετ για συστήματα Common Rail / Set para diagnóstico de sistemas Common Rail / Kit diagnostico per sistemi Common Rail / Kit de diagnóstico de sistemas Common Rail / Kit de diagnostic pour systèmes Common Rail / Common Rail diagnostische set

BOSCH
SIEMENS
DENSO
DELPHI



Ref.	☒	EAN
11-263	1/5	5907558435979

Zestaw do testowania systemów wtryskowych

Fuel injection injector pressure test set / Testsatz für Einspritzsysteme / Набор для проверки форсунок впрыска топлива / Набор для перевірки форсунок вприскування палива / Befecskendező rendszer tesztelő készlet / Set pentru testarea sistemelor de injecție / Sada pro testování vstřikovacích systémů / Súprava na testovanie vstrekovacích systémov / Set za testiranje injektorskih sistemov / Ipurškimo sistemu testavimo rinkinys / Degvielas iesmidzināšanas sprauslas pārbaudes instrumentu komplekts / Sissepritseüsteemide testimise komplekt / Комплект за диагностика на инжекционни системи / Set za ispitivanje sustava ubrizgivanja / Sistem za testiranje sistema za ubrizgavanje / Σετ ελέγχου ακροφυσίου έγχυσης καυσίμου / Kit para pruebas de sistemas de inyección / Kit per il test di sistemi di iniezione / Kit de testagem de sistemas de injeção / Kit d'essai pour systèmes à injection / Brandstofinjectie test set



0-10
BAR



Ref.	☒	EAN
11-264	1/5	5907558435986

Miernik ciśnienia sprężania

Compression tester / Verdichtungsdruckmesser / Компрессометр бензиновый / Компресометр / Kompresszió mérő készlet / Aparat de măsurat compresia / Měřicí přístroj kompresního tlaku / Merač kompresného tlaku / Merilec pritiska adapter / Kompresijos matuoklis / Kompresijas manometrs / Manometer adapterite komplekt / Компресометр / Mjerač pritiska / Merač pritiska sabijanja / Συμμετρητρο Βενζίνης / Medidor de aire comprimido / Misuratore della compressione / Medidor de pressão de compressão / Compressiometre compression / Meter van persdruk

70
BAR x16
DIESEL



Miernik kompresji do pomiarów ciśnienia sprężania w cylindrach silników wysokopięnych (diesla)
Zestaw zawiera różne adaptery pasujące do większości silników aut osobowych i dostawczych
Maksymalny zakres pomiaru – 70 barów

Pressure gauge for measuring compression pressure in diesel engine cylinders
The set includes various adapters suited for a majority of passenger and delivery vehicle engines
The maximum measurement range – 70 bars

Компресометр для вимірювання тиску в дизельних двигунах
Включає адаптери, які підходять для більшості двигунів легкових і вантажніків
Діапазон вимірювального тиску – до 70 бар

Ref.	☒	EAN
11-262	0/6	5907558416732

21
BAR



Miernik kompresji do pomiarów ciśnienia sprężania w cylindrach silników spalinyowych benzynowych
Zestaw zawiera adapter pasujący do większości silników aut osobowych i dostawczych
Maksymalny zakres pomiaru – 21 barów

Compression pressure gauge for measuring compression pressure in petrol combustion engine cylinders
The set includes an adapter suited for a majority of passenger and delivery vehicles
The maximum measurement range is – 21 bars

Компресометр для вимірювання тиску в бензинових двигунах
Включає адаптер, який підходить для більшості двигунів легкових і вантажних автомобілів
Діапазон вимірювального тиску – до 21 бар

Ref.	☒	EAN
11-261	0/20	5907558416725

Tester ciśnienia turbosprężarki

Turbo pressure gauge / Druckprüfgerät für Turbolader / Тестер турбо давления / Тестер тиску у турбокомпресорі / Turbófeltöltő nyomás tesztelő / Tester de presiune turbocompresor / Manometr pro kontrolu tlaku turba / Tester tlaku turbodúchadla / Preskuševalnik tlaka turbo kompresorja / Turbokompresorių testavimo rinkinys / Turbo spiediena mērtājs / Turbolaaduri rõhu tester / Тестер за налягане на турбокомпресор / Tester pritiska u turbokompresoru / Tester za pritisk turbokompresora / Ελεγκτής πίεσης turbo / Probador de presión para turbocompresor / Tester di pressione per turbocompressor / Aparelho de teste de pressão de turbocompressor / Testeur de pression d'huile turbocompresseur / Turbocompressor druk meter



-1 ÷ 3
BAR



Ref.	☒	EAN
11-265	1/10	5907558435993

Zestaw nasadek na przegubach, do świec zapłonowych

Set of sockets on joints, for spark plugs / Satz Steckschlüsseleinsätze für Zündkerzen / Комплект насадок на шарниры для свечей зажигания / Набор розеток на шарніри, для свічок запалювання / Csatlakozók készlete gyújtógyertyákhoz / Set prize pe îmbinări, pentru bujii / Sada objímek na klouby, pro zapalovací svíčky / Sada objímok na klby, pre zapalovacie sviečky / Komplet nastavkov na spojih, za vžigalne svečke / Kīštukinių lizdų komplektas ant jungčių, uždegimo žvakėms / Savienojumu lizdzu komplekts, aizdedzes svecēm / Liģendīte pesade komplekt, sūiitekūinalde jaoks / Комплект фасунел на шарнири, за свеци / Set utičnica na zglobovima, za svijeće / Сет утичница на зглобовима, за свећице / Σετ πριζών σε αρμούς, για μπουζί / Juego de vasos sobre juntas, para bujías / Serie di bussole su snodi, per candele / Conjunto de soquetes nas juntas, para velas de ignição / Jeu de douilles sur joints, pour bougies d'allumage / Set doppen op scharnieren, voor bougies

25
years
GUARANTEE

3/8"



x6

14 mm x 100 mm, 16 mm x 100 mm, 21 mm x 150 mm
14 mm x 150 mm, 16 mm x 150 mm, 16 mm x 280 mm



Ref.	☒	EAN
08-095	0/10	5907558473971

Tester ciśnienia oleju

Engine oil pressure tester / Druckprüfgerät für Öldruck / Тестер давления масла / Тестер тиску оливи / Olajnyomás tesztelő / Tester de presiune ulei / Tester tlaku oleje / Tester tlaku oleja / Preskuševalnik tlaka olja / Testalo slégio matuoklis / Ελεγκτής πίεσης λαδιού / Ölirőhu tester / Тестер за налягането на маслото / Tester pritiska ulja / Tester za pritisk ulja / Ελεγκτής πίεσης λαδιού / Probador de presión del aceite / Tester di pressione dell'olio / Aparelho de teste de pressão de óleo / Testeur de pression d'huile / Motorolie druk meter

0-10
BAR



Ref.	☒	EAN
11-266	1/2	5907558436006

Nasadka do świec

Spark plug socket / Aufsatz für Zündkerzen / Головка сменная свечная / Ключ свічний / Gyertyakulcs / Cheie tubulara pentru bujii / Nástavec na svíčky / Nástavec na sviečky / Nasadni ključ za svečke / Galvutė žvakėms / Sveču atslėga / Kūūnlapadrun / Насадка за свеци / Карика за свјеице / Nasadka za svećice / Καρυδάκι για μπουζί / Vaso para bujía / Chiave per candele / Bocal p. velas / Douille à bougie / Kaarsendop

CrV
steel

1/2"

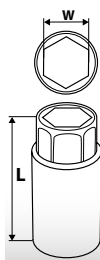

Ref.	W [mm]	L [mm]	☒	EAN
08-090	16	65	24/144	5907558406092
08-091	21	68	24/96	5907558406252

Klucz do świec

Spark plug wrench / Zündkerzenschlüssel / Ключ свечной / Ключ для свічок / Gyújtógyertyakulcs / Cheie lumînare / Klič na svíčky / Ključ sviečkový / Ključ za vžigalno svečko / Raktas degimo žvakėms / Svečatslēga / Süüteküünla vāti / Ключ / Ключ / Ключ / Ключи για μπουζί / Llave para bujía / Bussale poligonali / Chave p. velas / Clef à bougie / Kaarsleutel



3/8"



Ref.	W [mm]	L [mm]	☒	EAN
11-152	14	90	50/100	5907558417166
11-153	16	90	50/100	5907558417173

Szczypce do ściągania przewodów zapłonowych

Spark plug wire boot pliers / Zange zum Abziehen von Zündkabeln / Плоскогубцы для снятия проводов зажигания / Плоскогубцы для зняття дротів запалювання / Буйтókábel lehúzó fogó / Clește pentru scoaterea cablurilor de aprindere / Kleště na kabely zapalovacích svíček / Kliešte na demontáž zapalovacích vodičov / Klešče za vtiče vžigalnih svečic / Replij rinkiny, užvedimo laidų nužveinimui / Platknaiables aizdedzes vadu noņemšanai / Süütejuhtmete näripitsad / Клепцы за кабели на свецицте / Klješta za skidanje žica za paljenja / Klješta za skidanje kablova svećica / Πένσα εξαγωγής μπουζοκαλωδίων / Alicates para quitar los cables de arranque / Pinze per lo scollagamento dei cavi d'accensione / Alicates para extração de cabos de ignição / Pincas pour enlever les câbles batterie / Tangen voor bougie leidingen

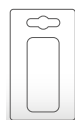
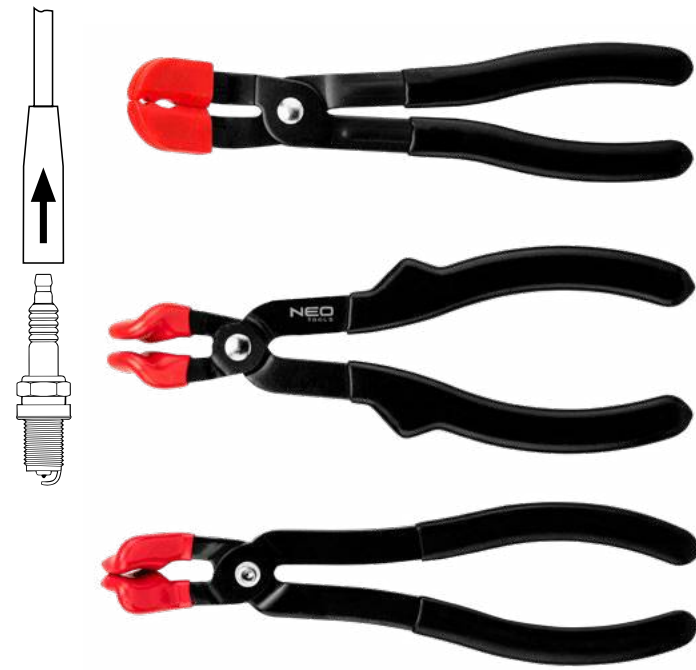

Ref.	☒	EAN
11-165	5/20	5907558437294

Tester szczelności uszczelki pod głowicą

Head gasket leak tester / Lecktester für Kopfdichtungen / Тестер герметичности прокладок головки блока цилиндров / Тестер герметичности прокладки головки / Fejtömítés szivárgásvizsgáló / Tester de scurgeri garniturii de cap / Tester těsnosti těsnění hlavy / Tester tesnosti tesnenia hlavy / Tester puščanja tesnila glave / Galvutės tarpiklio sandarumo testeris / Galvas blīves noplūdes testeris / Peatihendi lekke tester / Тестер за меч на уплътнението на главата / Ispitivač curenja brtve glave / Тестер цурења затпмне главе / Ελεγκτής διαρροής φλάντζας κεφαλής / Probador de fugas de juntas de culata / Cercafughe guarnizioni testa / Testador de vazamento da junta do cabeçote / Testeur de fuite de joint de culasse / Koppakking lektester



Ref.	☒	EAN
11-271	0/6	5907558474626

Szczelinomierz

Feeler gauge / Schiebelehre / Щуп / Щуп / Hézagmérő készlet / Calibru măsurare grosime / Spároměr / Lístkové mierky / Kontrolni lističi / Ertmių matavimo prietaisas / Spraugmērs / Möðtesond / Лыфмомер / Kontrolni lističi / Kontrolni lističi / Διακωνόμετρο / Calibre de espesores / Calibro a spessori / Medidor de folgas / Jauge d'épaisseur / Voelmaat

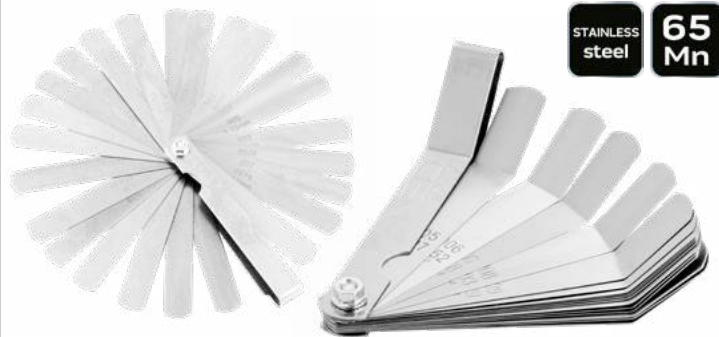

STAINLESS steel
65 Mn



Ref.	Ra [mm]	N	☒	EAN
11-190	0.04 - 0.63	26	20/120	5907558452433
11-191	0.05 - 1.0	20	20/120	5907558452440
11-192	0.127 - 0.508	16	20/120	5907558452457

Zestaw do demontażu poduszek powietrznych

Airbag removal tool set / Abbausatz für Luftkissen / Набор для замены подушки безопасности / Набор для заміни подушок безпеки / Légzsák kiszereelő készlet / Set pentru scoaterea airbag-urilor / Sada na demontáž airbagů / Súprava na demontáž airbagov / Set za odstranitev zračnih blazin / Oro pagalvių išmontavimo rinkinys / Drošības spilvena nomaiņas instrumentu komplekts / Õhkpatjade eemaldamise komplekt / Комплект за демонтаж на въздушни възглавници / Set za skidanje zračnih jastuka / Pribor za demontiranje vazdušnih jastuka / Σετ αντικατάστασης αερόσακου / Kit de desmontaje de airbags / Kit per lo smontaggio di airbag / Kit de ferramentas de desmontagem de airbags / Kit de démontage des airbags / Set voor demontage van airbags

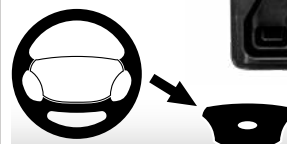

Ref.	☒	EAN
11-817	1/10	5907558436785

Ściągacz do ramion wycieraczek

Wiper arm puller / Abzieher für Scheibenwischer / Съемник рычагов стеклоочистителя / Знімач важелів склоочисників / Ablaktöröl kar lehúzó / Dispozitiv de scos de brate de stergător de parbriz / Stahováč na ramínka stieračů / Stahovač na demontáž ramienok stieračov / Snemalec za brisalce / Valytuvų kotų nuėmiklis / Stikla tīrītāju plecu novilcējs / Kojamehe hoobade tõmmits / Сноба за рамо на чистачната / Alat za skidanje brizgaljki / Alat za skidanje ramena brisača / Εξολκείας μοχλών υαλοκαθαριστήρα / Extractor de brazos de limpiaparabrisas / estrattore per braccio del tergicristallo / Extrator de limpa para-brisas / Extracteur de bras d'essuie-glaces / Trekker voor ruitenwisserarmen



Ref.	☒	EAN
11-827	0/120	5907558420067

Zestaw do demontażu szyby

Car windows disassembling set / Abbausatz für Scheiben / Набор для демонтажа лобовых стекол / Набор для демонтажу вітрового скла / Szélvédő kiserelő készlet / Set pentru demontarea geamurilor / Souprava pro demontáž skel / Súprava na demontáž okien / Set za odstranitev stekel / Automobilniy stiklu išmontavimo rinkinys / Autostiklu demontāžas komplekts / Tuuleklaasi eemaldamise komplekt / Комплект за демонтаж на автостъкла / Set za demontažu stakla / Pribor za demontiranje stakla / Σετ εξαγωγής παρμπροίτζ / Kit de desmontaje de ventanillas / Kit per lo smontaggio di cristalli / Kit de ferramentas de desmontagem de vidros / Kit de démontage de vitres



Ref.	📦	EAN
11-819	1/10	5907558436792

Zestaw nasadek specjalnych

Socket set / Aufsatzset / Набор головок торцевых / Набор насадок торцевых / Törtcsavarkihajító készlet / Set duze / Sada násadek / Súprava nástr. klúčov / Garnitura nasadnih ključev / Antgalių rinkinys / Muciju komplekts / Padrunikomplekt / Геодере компл / Šesterokutne kapice / Gedora set / Συλλογή καρδικιών / Llaves de vaso / Set di boccole / Kit de bicos / Jeu de douilles / Set van doppen

8, 10, 11, 12, 13, 14, 15, 16, 17, 19, 21, 22, 24, 27 mm

2 wybijaki do usuwania śrub z nasadek

2 x punches

2 выколотки для снятия винтов с головок

Možna stosovať z kľučkami udarowymi

Suitable for impact wrenches

Можно использовать с ударными гайковертами

Wewnętrzna spirala powoduje samoczynne zaciskanie się na uszkodzonej śrubie/nakrętce umożliwiając bezpieczne odkręcenie

The innovative spiral profile digs itself into the head of a damaged screw/nut and thereby allows to loosen it securely
Внутренняя спираль вызывает автоматическое зажатие поврежденного болта/гайки, обеспечивая безопасное откручивание

x16 1/2"



Ref.	📦	EAN
11-920	0/10	5907558436914

Zestaw nasadek specjalnych

Socket set / Aufsatzset / Набор головок торцевых / Набор насадок торцевых / Törtcsavarkihajító készlet / Set duze / Sada násadek / Súprava nástr. klúčov / Garnitura nasadnih ključev / Antgalių rinkinys / Muciju komplekts / Padrunikomplekt / Геодере компл / Šesterokutne kapice / Gedora set / Συλλογή καρδικιών / Llaves de vaso / Set di boccole / Kit de bicos / Jeu de douilles / Set van doppen

9, 10, 11, 12, 13, 14, 15, 16, 17, 19 mm

przetyczka 1 szt.

1 x punches

1 x штырь

Wewnętrzna spirala powoduje samoczynne zaciskanie się na uszkodzonej śrubie/nakrętce umożliwiając bezpieczne odkręcenie

The innovative spiral profile digs itself into the head of a damaged screw/nut and thereby allows to loosen it securely

Внутренняя спираль вызывает автоматическое зажатие поврежденного болта/гайки, обеспечивая безопасное откручивание



Ref.	📦	EAN
11-922	0/20	5907558436938

Przecinaki do nakrętek

Nut splitters / Meißel für Mutter / Гайколомы / Розривач до мутр / Csavaranyavágók / Dāļti pentru piulițe / Trháč matic / Trhače matic / Lomilci matic / Veržilių kirstukai / Uzgriežņu cirtņi / Meisliid / Сеначи за гайки / Rezač za matice / Sekač navrtanja / Κόφτες παξιμαδιών / Tajadera de tuercas / Spaccadadi / Cortadores de porcas / Burins à écrous / Moerknippers

oczko 9 - 12 mm/klucz 12 mm; oczko 12 - 16 mm/klucz 14 mm; oczko 16 - 22 mm/klucz 19 mm; oczko 22 - 27 mm/klucz 21 mm

9 - 12 mm nut splitter. Spaner drive shaft 12 mm; 12 - 16 mm nut splitter. Spaner drive shaft 14 mm; 16 - 22 mm nut splitter.

Spaner drive shaft 19 mm; 22 - 27 mm nut splitter. Spaner drive shaft 21 mm

размер гайки 9 - 12 мм / ключ 12 мм; размер гайки 12 - 16 мм / ключ 14 мм; размер гайки 16 - 22 мм / ключ 19 мм;

размер гайки 22 - 27 мм / ключ 21 мм



Ref.	📦	EAN
11-925	0/10	5907558436945

Zestaw do uszkodzonych śrub

Broken bolt kit / Satz gebrochene Schrauben / Комплект сломанных болтов / Комплект зламаних болтів / Törött csavar készlet / Kit şuruburi rupte / Sada zlomených šroubů / Súprava zlomených skrutiek / Komplet zlomljenih vijakov / Sulaužytų varžtų rinkinys / Bojātu skrūvju komplekts / Purunened poltide komplekt / Комплект слупнени болтове / Set za oštećene vijke / Set за оштећене шрафове / Kit опасрμένων μπουλονιών / Kit de tornillos rotos / Kit di bulloni rotti / Kit de parafusos partidos / Kit de boulons cassés / Kit met gebroken bouten



Ref.	☒	EAN
11-923	0/10	5906692015450

Miska magnetyczna, kątowa

Magnetic bowl, angular / Magnetschale, eckig / Магнитная чаша, угловая / Миска магнітна, кутова / Mágneses tál, szögletes / Bol magnetic, unghiular / Magnetická miska, hranatá / Magnetická miska, hranatá / Magneta posoda, kotna / Magnetinis dubuo, kampinis / Magnētiskā bļoda, kantaina / Magnetkauss, purgelīne / Магнитна купа, ъглова / Magneta zdjela, ugaona / Магнетна посуда, угаона / Магнетичко мпола, ѱγνιώδες / Сисенпо магнетича, ауглар / Ciotola magnetica, angular / Tigela magnética, angular / Bol magnétique, angulaire / Magnetische schaal, hoekig



Ref.	☒	EAN
11-617	0/12	5907558499834

Miska magnetyczna

Magnetic tray / Magnetschüssel / Поддон магнитный / Піддон магнітний / Mágneses tál, rozsdamentes / Tava magnetica / Magnetická miska / Magnetická miska / Magneta posoda / Magnetinis dubuonelis / Magnētiskais trauks / Magnetkauss / Магнетична тарелка / Magnetska posuda / Magneta činija / Μαγνητικός δίσκος / Plato magnético / Vassoio magnetico / Tacho magnético / Réceptier magnétique / Magnetische oprangbak



Ref.	L x W [mm]	☒	EAN
11-614	245 x 145	0/24	5907558419702

Chwytnik magnetyczny

Magnetic holder / Magnetgreifer / Магнитный захват / Тримач магнітний / Mágneses csavarkészadó teleszkópos / Graifär magnetic / Magnetická úchytka / Magnetický zdvihák / Magneta držalo / Magnetinis laikiklis / Magnētiskais satvērējs / Magnethaarats / Магнетичен захват / Magnetska hvatajka / Magnetni hvatač / Μαγνητική αρπάγη / Agarrador magnético / Supporto magnetico / Caçamba magnética / Preneuse magnétique / Magnetisch houder

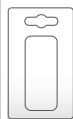

Ref.	☒	EAN
11-610	0/200	5907558418569



Ref.	☒	EAN
11-611	0/100	5907558418576

Lusterko inspekcyjne

Inspection mirror / Inspektionsspiegel / Зеркало инспекционное / Дзеркальце інспекційне / Vizsgálótükör teleszkópos nyéllel / Oglindă de inspecție / Zrcadlo pro inspekční kontroly / Inšpekčné zrkadlo / Kontrolno ogledalo / Voizdo veidrodelis / Inspekcijas spogulis / Kontrollpeegel / Контролно огледалце / Kontrolno ogledalo / Ogljedalo za inspekciju / Καθρεπτάκι ελέγχου / Espejo de inspección / Specchietto per ispezione / Espelho de inspeção / Miroir d'inspection / Inspectiespiegel

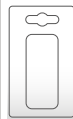

Ref.	☒	EAN
11-612	0/200	5907558418583

Refraktometr

Refraktometer / Refraktometer / Рефрактометр / Рефрактометр / Refraktométer / Refraktometru / Refraktometr / Refraktometer / Refraktometer / Refraktometras / Refraktometers / Refraktomeeter / Рефрактометър / Refraktometar / Refraktometar / Διαθλασίμετρο / Refractorómetro / Rifraktometro / Refratómetro / Refractometre



Ref.	☒	EAN
11-270	0/50	5907558436020

Nitownica

Riveter / Nietmaschine / Заклепочник / Клепальный инструмент / Popszegecszűzó / Mašínà de nituit / Nýtovačka / Kliešte nitovacie ocelové / Pištola za kovičenje / Kniediklis / Kniežu stangas / Needitangid / Humačka / Klijesta za zakovice / Pistolj za pop nitne / Hлаи / Remachadora / Rivettatrice / Rebitadora / Riveuse / Klinknagelmachine



Steel	Ø 2.4/3.0/3.2/4.0/4.8/5.0 mm	Al	Ø 2.4/3.0/3.2/4.0/4.8/5.0 mm
Cu	Ø 2.4/3.0/3.2/4.0/4.8/5.0 mm	Stainless Steel	Ø 2.4/3.0/3.2/4.0 mm

Ref.	Ø [mm]	L [mm]	⊠	EAN
18-101-1	2.4/3.2/4.0/4.8	264	6/24	5907558497304



Steel	Ø 2.4/3.0/3.2/4.0/4.8/5.0 mm	Al	Ø 2.4/3.0/3.2/4.0/4.8/5.0 mm
Cu	Ø 2.4/3.0/3.2/4.0/4.8/5.0 mm	Stainless Steel	Ø 2.4/3.0/3.2/4.0/4.8/5.0 mm

Ref.	Ø [mm]	L [mm]	⊠	EAN
18-103-1	2.4/3.2/4.0/4.8	265	6/24	5907558497328

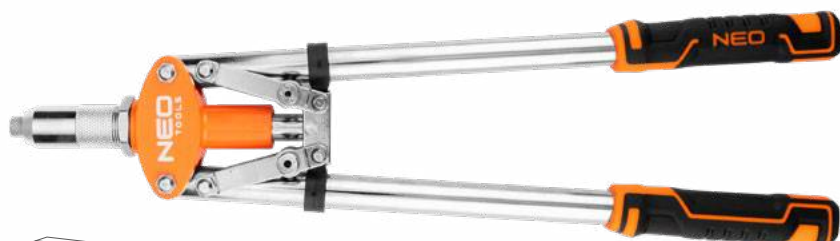

Steel	Ø 2.4/3.0/3.2/4.0/4.8/5.0/6.0/6.4 mm	Al	Ø 2.4/3.0/3.2/4.0/4.8/5.0/6.0/6.4 mm
Cu	Ø 2.4/3.0/3.2/4.0/4.8/5.0/6.0/6.4 mm	Stainless Steel	Ø 2.4/3.0/3.2/4.0/4.8/5.0/6.0/6.4 mm

Ref.	Ø [mm]	L [mm]	m [kg]	⊠	EAN
18-106-1	3.2/4.0/4.8/6.0/6.4	480	1.95	0/12	5907558497380



Steel	Ø 2.4/3.0/3.2 mm	Al	Ø 2.4/3.0/3.2/4.0/4.8/5.0 mm
Cu	Ø 2.4/3.0/3.2 mm	Stainless Steel	Ø 2.4 mm

Ref.	Ø [mm]	L [mm]	⊠	EAN
18-102-1	2.4/3.2/4.0/4.8	280	6/24	5907558497311



Steel	Ø 2.4/3.0/3.2/4.0/4.8 mm	Al	Ø 2.4/3.0/3.2/4.0/4.8 mm
Cu	Ø 2.4/3.0/3.2/4.0/4.8 mm	Stainless Steel	Ø 2.4/3.0/3.2/4.0/4.8 mm

Ref.	Ø [mm]	L [mm]	m [kg]	⊠	EAN
18-107	2.4/3.2/4.0/4.8	275	0.75	6/24	5907558413564

Nitownica akumulatorowa

Riveter / Nietmaschine / Заклепочник / Клепальный инструмент / Popszegecszűzó / Mašínà de nituit / Nýtovačka / Kliešte nitovacie ocelové / Pištola za kovičenje / Kniediklis / Kniežu stangas / Needitangid / Humačka / Klijesta za zakovice / Pistolj za pop nitne / Hлаи / Remachadora / Rivettatrice / Rebitadora / Riveuse / Klinknagelmachine

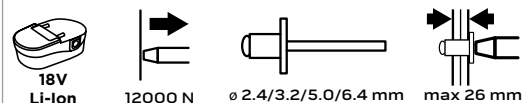

Ref.	⊠ [kg]	⊠	EAN
04-617	1.72	0/5	5907558496000

Palnik gazowy

Gas burner / Gasbrenner / Горелка газовая / Пальник газовой / Forrasztófej / Arzător de gaz / Plynový hořák / Horák / Plinski gorilnik / Dujinis degiklis / Gāzes deglis / Gaasipöleti / Нагрівник за горелка / Nastavak za plamenik / Gasna lemilica / Καυστήρας υγραερίου / Soplete / Bescuccio / Maçarico de gás / Chalumeau à gaz / Gasbrander



Ref.	info	T [°C]	P [kW]	☒	EAN
20-025		1300	1.3	10/100	5907558449648
20-041	+ 20-030	1300	1.3	10/100	5907558486773
20-040	+ 2 x 20-030	1300	1.3	10/100	5907558465747

Lampa lutownicza

Liquid gas blow-lamp / Lötlatze / Лампа паяльная / Газ рідкий для лампи паяльної / Forrasztókészülék / Lampă sudat cu gaz lichid / Pájeci lamp / Pájkováčka plynová / Plinski gorilnik / Litavimo lempa / Lodlampa / Jootelamp (vedelgaas) / Лампа газова / Plinska lemilica / Gasna lemilica / Καμινέτο υγραερίου / Lámpara de soldar a gas / Lampada per saldare / Lâmpada p. Soldar / Lampe à braser / Soldeerlamp



Ref.	T [°C]	q [g/h]	P [kW]	☒	EAN
20-021	1350	87	1.2	0/12	5907558455151



Ref.	info	T [°C]	q [g/h]	P [kW]	☒	EAN
20-022		1350	87	1.2	0/12	5907558455168
20-045	+ 4 x 20-033	1350	87	1.2	0/12	5907558488265



Ref.	T [°C]	P [kW]	☒	EAN
20-026	1350	1.28	10/60	5907558465365

Nabój z gazem butan

Butane gas cartridge / Butan-Gas-Patrone / Баллон с газом бутан / Балончики (картриджи) з газом бутан / Tartály gázlámpához / Cartuş cu gaz butan / Kartuše s plynem butan / Butánová kartuša / Jeklenka s plinom butan / Butano dujų balionas / Balons ar butāna gāzi / Butaan-gaasipadrun / Бутилка с газ бутан / Patrona sa butan plinom / Patrona sa butan gasom / Δοχείο με μείγμα βουτανίου / Cartucho de gas butano / Bombola di gas / Cartuxo com gás / Cartouche avec gaz butane / Butaan vervangcartridge



Ref.	m [g]	☒	EAN
20-033	190	0/48	5907558468939



Ref.	m [g]	☒	EAN
20-036	500	0/12	5907558468946

Nabój z gazem butan

Butane gas cartridge / Butan-Gas-Patrone / Баллон с газом бутан / Балончики (картриджи) з газом бутан / Tartály gázlámpához / Cartuş cu gaz butan / Kartuše s plynem butan / Butánová kartuša / Jeklenka s plinom butan / Butano dujų balionas / Balons ar butāna gāzi / Butaan-gaasipadrun / Бутилка с газ бутан / Patrona sa butan plinom / Patrona sa butan gasom / Δοχείο με μείγμα βουτανίου / Cartucho de gas butano / Bombola di gas / Cartuxo com gás / Cartouche avec gaz butane / Butaan vervangcartridge



Ref.	m [g]	☒	EAN
20-030	227	4/28	5907558449655

Mikropalnik

Microtorch / Mikrobrenner / Микрогорелка / Мініпаяльник / Forrasztókészülék piezos / Microinjector / Mikrohořák / Mikro pajkovačka / Gorilnik / Mikro degiklis / Lodlampa mini / Mikroleeklamp / Горелка микро / Mikro Plinska lemilica / Mikro gasna lemilica / Φλόγιστρο / Microsoplete / Micro bruciatore / Mikromaçarico / Micro-brûleur / Microbrander



Ref.	📦	EAN
19-906	50/200	5907558465730



Ref.	📦	EAN
19-907	10/60	5906692016471

Lutownica bezprzewodowa

Cordless soldering iron / Kabelloser LötKolben / Аккумуляторный паяльник / Аккумуляторный паяльник / Akkumulátoros forrasztópáka / Fier de lipit fără fir / Akumulátorová páječka / Bezdrôtová spájkovačka / Brezžični spajkalnik / Belaidis lituoklis / Bezvadu lodāmurs / Juhtmeta jootekolb / Безжичен паялник / Bežično lemilo / Безжична лемилница / Ασύρματο κολλητήρι / Soldador inalámbrico / Soldatore a batteria / Ferro de soldar sem fios / Fer à souder sans fil / Draadloze soldeerbout



Ref.	📦	EAN
19-250	10/20	5907558491449

Końcówki do lutownicy

Soldering tips / Lötspitzen / Наконечники для паяльника / Наконечники до лютувальника / Forrasztóhegyek / Carpe pentru ciocan de lipit / Концовку про páječku / Nástavec spájkovačky / Kopice za spajkalnik / Antgaliai lituokliui / Lodēšanas uzgaļi / Jootekolbi otsakud / Накрайници за паялника / Vrhovi za lemilicu / Nastavci za lemljenje / Μύτες κολλητηρίου / Boquillas para soldar / Inserti per soldatore / Ponteiros p. soldador / Embouts de fer à souder / Soldeereindstukken



Ref.	📦	EAN
19-225	0/500	5907558468922



Ref.	📦	EAN
19-908	10/60	5906692016488

Stacja lutownicza

Soldering station / Lötstation / Паяльная станция / Паялна станция / Forrasztóállomás / Stație de lipit / Pájeci stanice / Spájkovacia stanica / Spajkalna postaja / Litavimo stotis / Lodēšanas stacija / Jootejagam / Станция за запояване / Postaja lemilice / Stanica lemilice / Σταθμός κόλλησης / Estación de soldadura / Stazione di saldatura / Estação de solda / Poste de soudure / Soldeerstation



Ref.	📦	EAN
19-200	0/12	5907558468908

Kolba lutownicza

Soldering tool / LötKolben / Паяльник / Паялна колба / Forrasztópáka / Fier de lipit / Pájeci ručka / Spájkovacie pero / Spajkalnik / Lituoklis / Lodāmurs / Jootekolb / Паялник / Lemilica / Lemilica / Κολλητήρι / Soldador / Soldatore / Ferro de soldar / Fer à souder / Soldeerbout



Ref.	📦	EAN
19-220	0/80	5907558468915

Lutownica transformatorowa

Soldering gun / Trafo-Lötkolben / Паеньник трансформаторный / Паеньний ністолем / Forrasztópisztoly / Ciocan de lipit / Pájeci stanice s transformátorem / Pájkovacka elektronická / Spajkalnik / Transformatorinis lituoklis / Lodāmurs ar transformatoru / Jootepüstol / Поеньник / Pištalj lemilica / Pistalj lemilica / Ηλεκτρικό κολλητήρι με μετασχηματιστή / Pistola para soldar / Pistola per saldatura / Soldador por transformador / Fer à souder redresseur / Transformator soldeerbout



Ref.	⊠	EAN
19-152	0/10	5907558472059

Lutownica do plastiku + zszywki

Plastic welder + staples / Kunststoffschweißgerät + Heftklammern / Сварщик пластика + скобы / Зварювач пластику + скобу / Műanyag hegesztő + kapcsok / Sudor plastic + capse / Svářečka plastů + sponky / Zváračka plastov + sponky / Varilec plastike + sponke / Plastikinis suvirintojas + kabės / Plastmasas metinātājs + skavas / Plastikust keevitaja + klambrid / Пластмассов заварчик + скобу / Varilica za plastiku + spajalice / Пластични заварувач + снајалуце / Пластиковы суварчыкі + сувдеітэры / Soldador de plástico + grapas / Soldatore plastica + graffette / Soldador de plástico + grampos / Soudeuse plastique + agrafes / Kunststof lasapparaat + nietjes /



Ref.	⊠	EAN
19-158	0/10	5907558475272

Zszywki do plastiku

Staples for plastic / Heftklammern für Kunststoff / Скобы для пластика / Набір пластикових скоб / Tűzőkapcsok műanyaghoz / Capse pentru plastic / Svorky na plasty / Svorky na plasty / Sponke za plastiko / Plastikno sqvarželes / Plastmasas skavas / Plastist klambrid / Скобу за пластмаса / Plastične spajalice / Пластичне снајалуце / Συρραπτικά για πλαστικό / Grapas para plástico / Puntti metallici per plastica / Agrafos para plástico / Agrafes pour plastique / Nietjes voor plastic



Ref.	⊠	EAN
19-151	0/10	5907558464696



Ref.	⊠	EAN
19-159	25/50	5907558475289

Punktak

Centre punch / Körner / Кернер / Кернер / Pontozó / Punctator / Důlčik / Raznik / Točkaló / Žymeklis / Punktisītis / Augumārgīstis / Керна / Rični bušać / Obeleživač / Πόντα σίδηρου / Punzón centrador / Punzone / Punção / Pointeau / Doorslag



Ref.	⊠	EAN
19-153	0/6	5907558472066



Ref.	⊠	EAN
33-090	0/20	5907558426243

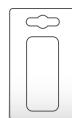

Wyciskacz do tub

Caulking gun / Auspresser für Tuben / Выжиматель / Толок для витискання монтажноі піни / Kinyomópisztoly / Comprimador de tuburi / Aplikáční pistole na tuby / Vytlačáč túb / Pištola za tube / Hermetiko pistoletas / izspiedējs / Torutõmmits / Измисковач за тубы / Istiskivač za tube / Istiskivač za tube / Πιστόλι αλκόνης / Pistola para tubos / Pistola per cartucce / Espremedor para tubos / Pistolet pour tubes / Afichtingspistool



Ref.	L [mm]	☒	EAN
61-001	240	0/24	5907558405842



Ref.	L [mm]	☒	EAN
61-002	240	0/12	5907558405859



3 trzpienie wyciskające
3 forcing pins
3 отжимных штифта

Ref.	L [mm]	☒	EAN
61-004	240	0/12	5907558420821



Ref.	V [ml]	L [mm]	☒	EAN
61-005	310	254	0/12	5907558420838
61-006	600	389	0/12	5907558420845

Mikrometr noniusowy

Vernier micrometer / Feinmessschraube / Верньерный микрометр / Мікрометр Верньєра / Nulllås mikrométer / Micrometru Vernier / Vernierovský mikrometr / Vernierov mikrometer / Vernierjev mikrometer / Vernier mikrometras / Verniję mikrometrs / Vernier mikromeeter / Микрометр Верние / Vernier mikrometar / Нонус микрометар / Мікрометра Вернієрас / Micrómetro vernier / Micrometro a corsoio / Micrómetro Vernier / Micromètre à vernier / Vernier-micrometer



Ref.	Ra [mm]	☒	EAN
75-020	0-25		5907558491548
75-021	25-50		5907558491555
75-022	50-75		5907558491562
75-023	75-100		5907558491579

Suwmiarka

Caliper / Messschieber / Штангенциркуль / Штангенциркуль / Tolómérő / Suport / Posuvné měřítlo / Meradlo posuvné / Pomíčno merilo / Slankmatis / Bidmērs / Mõõtesirkel / Шублер / Pomíčno mjerilo / Pomocno merilo / Αναλογικό παχύμετρο / Calibre / Calibro / Calibrador de corrección / Pied à coulisse / Schuifmaat

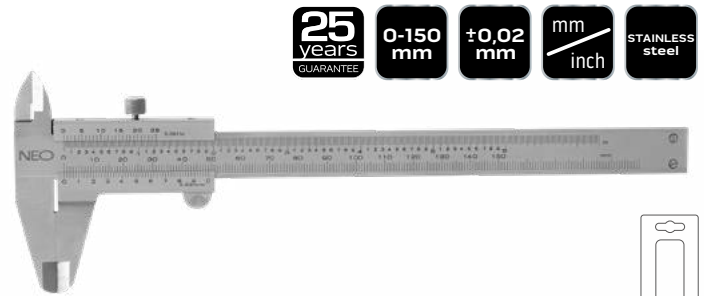

Ref.	L [mm]	Ra [mm]	☒	EAN
75-000	234	0-150	10/10	5907558406757



Ref.	L [mm]	Ra [mm]	☒	EAN
75-001	230	0-150	5/25	5907558409468



Ref.	L [mm]	Ra [mm]	☒	EAN
75-011	237	0-150	5/25	5907558408614

NORMALIA WARSZTATOWE

workshop standard items стандартні предмети майстерні



Szczypce do klipsów

Trim clip removal pliers / Trimmzange zum Entfernen des Clips / Плоскогубцы для удаления клипсы / Плоскогубцы для удаления клипсы / Vágókarocs-eltávolító fogók / Cliesti pentru scoaterea clemelor / Kleště na odstranění klipů / Kliešte na odstraňovanie spôn / Klešče za odstranjevanje sponk / Sqvaržų šalinimo rėplės / Klipi porėtšanas knaibles / Klambrite eemaldamise tangid / Клещи за премахане на клип / Kliešta za uklanjanje isječka / Кљешта за уклањање клипа / Πένσα αφαίρεσης κλιπ / Recorte alicates de extracción de clip / Pinza per tagliare clip / Alicates de remoção de cliques de acabamento / Pince pour enlever les clips / Tang voor verwijderen van clip

25 years
GUARANTEE

35x35 mm



Ref.	⊞	EAN
11-030	6/36	5907558445527

Zestaw ściągaczy do tapicerki

Upholstery puller set / Lösehebel-Satz für Polster / Набор съёмников панелей облицовки / Набор знімачів до обивки салону / Kárpiteszedő készlet / Set de scos piese de tapiterie / Sada pro demontáž čalounění / Súprava na demontáž čalúnenia / Set smnalcev oblazinjenja / Tvirtinimo elementų ištraukikliai / Tapšėjuma novilcėju / Polstriřtõmmitsate / Комплект скобу за тапицерия / Set za skidanje tapicerung / Pribor alata za skidanje tapetarskog materijala / Σετ εξαλλκείς πλακών επένδυσης / Juego de extractores de tapizado / Serie di utensili per interni / Conjunto de extratores para tapeçaria / Jeu d'extracteurs de tapisserie / Set van trekkers voor stoffering



Ref.	⊞	EAN
11-825	6/12	5907558436808

NYLON



Ref.	N	⊞	EAN
11-822	x5	6/24	5907558420029
11-823	x6	6/24	5907558420036
11-824	x11	0/10	5907558420043

Opaska ślimakowa

Hose clamp / Schneckenschelle / Хомут червячный / Хомут гвинтований / Tömblöbilincs / Brätaå cu melc / Šneková spona / Stáhovacia páska kovová / Objemka na polža / Sqvarža / Gliemežšavilcējs / Toruklamber / Скоба с червячна резба / Obujnica sa ružnikov navojem / Šelna / Обонτωός σφιγκτήρας σωλήνα / Bidas / Fascetta a vite / Abraçadeira caracol / Collier de serrage

STAINLESS steel

W4



Ref.	∅ [mm]	N	⊞	EAN
11-400	8-12 / 9 mm	x3	0/200	5907558420425
11-401	10-16 / 9 mm	x3	0/200	5907558420432
11-402	12-20 / 9 mm	x3	0/200	5907558420449
11-403	16-27 / 9 mm	x3	0/200	5907558420456
11-404	20-32 / 9 mm	x3	0/200	5907558420463

x34



Ref.	⊞	EAN
11-981	0/20	5907558435764

Nity

Rivets / Niete / Закленки / Закленки / Alu popszegecs készlet / Nituri / Nýty / Nity / Zakovice / Kniedes / Kniedes / Needitangid / Нитове / Zakovice / Nitna / Πριτσάνα / Remaches / Rivetti / Rebites / Rivets / Klinknagels /

AL x400



Ref.	∅ [mm]	⊞	EAN
11-970	2.4, 3.2, 4.0, 4.8	0/20	5907558437126

Zestaw spinek samochodowych

Car pins / Auto-Körper-Clipsset / Клипсы крепления обшивки / Набор кліпс кріплення обшивки / Gépkocsi rögzítő patent készlet / Set de clipuri auto / Sada přichytek čalounění / Súprava sponek do auta / Set avtomobilskih sponk / Avtomobilinių tvirtinimo elementų rinkinys / Apšuvimo stiprinājumi komplekts / Autotihvīde komplekt / Комплект автомобильни щипки / Set spona za vozila / Komplet spojnice za automobile / Κλιπς ταπεταρίας / Kit de remaches de coche / Set di clip per carrozzeria / Luvas de nitrilo laranja / Ensemble d'épingles auto / Auto pinnen



x300

OPEL

Ref.	☒	EAN
11-952	0/28	5907558436990



x345

PEUGEOT

Ref.	☒	EAN
11-953	0/28	5907558437003



x408

HONDA

Ref.	☒	EAN
11-956	0/28	5907558437034



x415

MITSUBISHI

Ref.	☒	EAN
11-960	0/28	5907558437072



x290

BMW

Ref.	☒	EAN
11-961	0/28	5907558437089



x360

TOYOTA
LEXUS

Ref.	☒	EAN
11-950	0/28	5907558436976



x255

VOLKSWAGEN

Ref.	☒	EAN
11-963	0/28	5907558437102

Pierścienie segera

Seeger rings / Seeger-Ring / Стопорные кольца / Кільця стопорні / Seeger gyűrűk / Inele Seeger / Segerové kroužky / Segerove krúžky / Seger obroči / Žiedai Segera / Arējie un iekšējie spriegredzeni / Seeger ringid / Зеєрки / Uskačnici / Seger prstenovi / Δακτύλιοι συγκράτησης / Anillos seger / Anelli Seeger / Anéis Seeger / Anneaux élastiques / Segger ringen

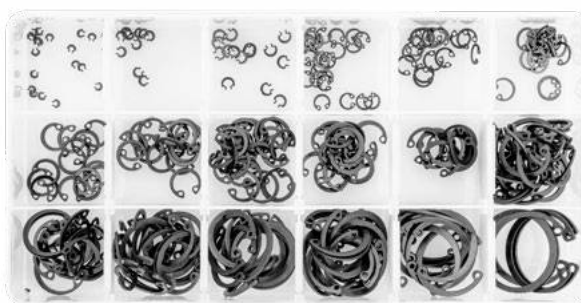

x300

Ref.	☒	EAN
11-975	0/20	5907558437171

Nakrętki samohamowne

Self-locking nuts / Selbstsichernde Muttern / Самоконтрящиеся гайки / Гайки самоконтряючі / Űnzáró anyák / Piulițe cu auto-blocare / Samosvorné matice / Samosvorné matice / Samozaporne matice / Savaitne užsifiksuojančios veržlės / Pašbremzėjošie uzgriežni / Iseblokeeruvad mutrid / Самозаконтрящи гайки / Samokočive matice / Samokočne matice / Παξιμάδια αυτοσφραλιζόμενα / Tuercas autoblocantes / Dadi autobloccanti / Porcas autotravantes / Écrous freins / Zelfverschuilende moeren

x146



Ref.	Ø [nr]	☒	EAN
11-972	M4 - M12	0/20	5907558437140

Korki z uszczelkami miedzianymi

Drain plugs and cover pads / Verschlusschrauben mit Kupferdichtungen / Набор медных прокладок и пробок / Набор мідних прокладок і пробок / Menetes dugó és rézalátét készlet / Buşoane cu garnituri din cupru / Zátky s měděným těsněním / Zátky s medenými tesneniami / Čepi za medeninastimi tesnilili / Variniai kamščiai ir tarpinės / Väciņi ar vara starplikām / Vasktihenditega korgid / Пробки за източване с медни уплътнения / Zatvarači s mesingastim brtvama / Komplet čerova sa bakarnim zaprtivcima / Σετ χάλκινων παρεμβυσμάτων και ταπών / Tapones con juntas de cobre / Tappi con guarnizioni in rame / Tampões com anéis de cobre / Bouchons avec joints en cuivre / Krukken met messing dichting

x534



Ref.	☒	EAN
11-974	0/10	5907558437164

Podkładki miedziane

Coper pads / Unterlegscheiben aus Kupfer / Медные шайбы / Шайби мідні / Réz alátétek / Şaibe de cupru / Měděné podložky / Medené podložky / Medeninaste podložke / Varinés tarpinės / Vara starplikas / Vasest seibid / Медни шайби / Mesingasti podložci / Bakarne podložke / Χάλκινες ροδέλες / Arandelas de cobre / Rondelle in rame / Anéis de cobre / Rondelles en cuivre / Roestvrije onderringen

x300

Cu



Ref.	☒	EAN
11-971	0/10	5907558437133

x150

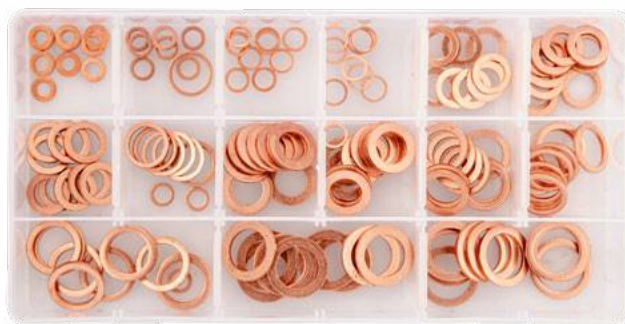

Ref.	☒	EAN
11-979	0/20	5907558435740

Zestaw smarowniczek

Set of lubricating nipples / Ölerset / Набор маслёнок / Набор оливиць / Zsízószem készlet / Set de cãni de ungere / Sada mazniček / Súprava mazniček / Komplet mazalic / Sutepimo dozatorių komplektas / Eļļas kanniņu komplekts / Määrdepritside komplekt / Комплект ръчни маслёнки / Set dozera za mazivo / Komplet maziva / Σετ ελαιοδεξαμενών / Juego de pistolas engrasadoras / Completo di punti di ingrassaggio / Kit de lubrificadores / Jeu de tubulure de graissage / Set van smeernippels

x110



Ref.	☒	EAN
11-973	0/20	5907558437157

Sprężyny

Springs / Federn / Пружини / Пружини / Rugó készlet / Arcuri / Pružiny / Pružiny / Vzmeti / Spyruoklių rinkinys / Atsperes / Vedrud / Пружини / Opruge / Opruge / Σετ ελατήρια / Espirales / Molle / Molas / Ressorts / Veren

x200



Ref.	☒	EAN
11-980	0/20	5907558435757

Koszulki termokurcziwe

Heat shrink sleeves / Wärmeschumpfende Hüllen / Термоусадочные рукава / Рукави термоусадочни / Zsugorcsó készlet / Manşoane termocontractabile / Teplom smršťitelné rukávy / Teplom zmršťitelné návleky / Toplotno-skrćne spojke / Termiškai susitraukiančios rankovės / Termorucigās uzmaivas / Termokahanevad sãrgid / Термосуваеми рукави / Termo savitļjivi rukavi / Rukavi koji se skupļjaju na toploti / Θερμοσυστελλόμενα μονωτικά καλωδίων / Mangas termoencogibles / Guaine termorestringenti / Mangas termoretráteis / Gaines thermorétractables / Thermokrimp mouwen

x127



Ref.	☒	EAN
11-978	0/20	5907558437201

Koszulki termokurcziwe "samolutujące"

Heat-shrink solder sleeves / Schrupfschläuche / Термоусадочные трубки «самоустанавливающиеся» / Термоусадочни тръбки «Самопайка» / Hőre zsugorodó, „önforrasztó” cső / Manşoane termocontractabile „auto-lipire” / Smršťovací „pájecí” spojky s cinem / Termozmršťovacie bužirky „samospájkovacie” / Termokrćljive tape / Karštyje susitraukiantys vamzdėliai / "Pašlodėjošas" termiskas sarašanās caurules / "Isejotvad" termokahanevad torud / Термосуваеми маркучи „самопоявацци” / "Samolemljive" termoskupļjajuće košuljice / "Samolemljive" termoskupļjajuće košuljice / Θερμοσυστελλόμενα μακαρόνια / Mangas termoencogibles / Guaine termorestringenti / Mangas termoretráteis / Gaines thermorétractables / Thermokrimp mouwen

100 pcs
0.25 - 6.0 mm



Ref.	☒	EAN
11-969	1/200	5907558471069

Uszczelki (O-ring NBR)

Seals (O-ring NBR) / Dichtungen (O-ring NBR) / Прокладки (O-ring NBR) / Прокладки (O-ring NBR) / Tömítés készlet (o-gyűrű nbr) / Garnturi (O-ring NBR) / Těsnění (O-ring NBR) / Tesnenia (O-ring NBR) / Tesnila (O-ring NBR) / Tarpinés (O-ring NBR) / Blives (O-ring NBR) / Tihendid (O-ring NBR) / Гарнитури (O-ring NBR) / Brtvila (O-ring NBR) / Zaptivke (O-ring NBR) / Ταμώχες (O-ring NBR) / Juntas de calafateo (O-ring NBR) / Guarnizioni (O-ring NBR) / Vedantes (O-ring NBR) / Joints (O-ring NBR) / Dichtringen (O-ring NBR)

x225



Ref.	☒	EAN
11-977	0/20	5907558437195

Uszczelki (O-ring HNBR)

Seals (O-ring HNBR) / Dichtungen (O-ring HNBR) / Прокладки (O-ring HNBR) / Прокладки (O-ring HNBR) / Tömítés készlet (O-gyűrű hnbr) autóklimához / Garnturi (O-ring HNBR) / Těsnění (O-ring HNBR) / Tesnenia (O-ring HNBR) / Tesnila (O-ring HNBR) / Tarpinés (O-ring HNBR) / Blives (O-ring HNBR) / Tihendid (O-ring HNBR) / Гарнитури (O-ring HNBR) / Brtvila (O-ring HNBR) / Zaptivke (O-ring HNBR) / Ταμώχες (O-ring HNBR) / Juntas de calafateo (O-ring HNBR) / Guarnizioni (O-ring HNBR) / Vedantes (O-ring HNBR) / Joints (O-ring HNBR) / Dichtringen (O-ring HNBR)

x270



Ref.	☒	EAN
11-976	0/20	5907558437188

Uszczelki

Seals / Dichtungen / Прокладки / Прокладки / Tömítések / Garnturi / Těsnění / Tesnenia / Tesnila / Tarpinés / Blives / Tihendid / Гарнитури / Brtvila / Zaptivke / Ταμώχες / Juntas de calafateo / Guarnizioni / Vedantes / Joints / Dichtringen

x419

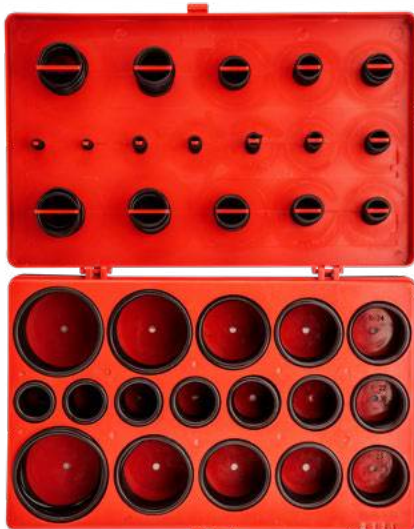

Ref.	☒	EAN
11-983	1/20	5907558435788

Zestaw bezpieczników samochodowych

Car fuse / Set von Auto-Sicherungen / Набор автомобильных предохранителей / Набор запобіжників автомобільних / Gépkocsi biztosíték szett / Set de siguranțe auto / Sada pojistek do auta / Sada automobilových pojistiek / Set avtomobilskih varovalk / Automobiliu saugiklių rinkinys / Automašīnu drošinātāji / Autokaitsmete komplekt / Комплект автомобильни предпазители / Set osigurača za auto / Komplet svečica za avtomobil / Σετ ασφαλείας αυτοκινήτου / Conjunto de fusibles de coche / Set di fusibili per auto / Kit de fusíveis de automóveis / Ensemble de fusibles auto / Auto bougies

x88



Ref.	☒	EAN
11-993	0/20	5907558435818

Zestaw bezpieczników samochodowych

Car fuse / Set von Auto-Sicherungen / Набор автомобильных предохранителей / Набор запобіжників автомобільних / Gépkocsi biztosíték szett / Set de siguranțe auto / Sada pojistek do auta / Sada automobilových poistiek / Set avtomobilskih varovalk / Avtomobilinių saugiklių rinkinys / Automašīnu drošinātāji / Autokaitismete komplekt / Комплект автомобильни предпазители / Set osigurača za auto / Komplet svečica za automobil / Σετ ασφάλειες αυτοκινήτου / Conjunto de fusibles de coche / Set di fusibili per auto / Kit de fusíveis de automóveis / Ensemble de fusibles auto / Auto bougies

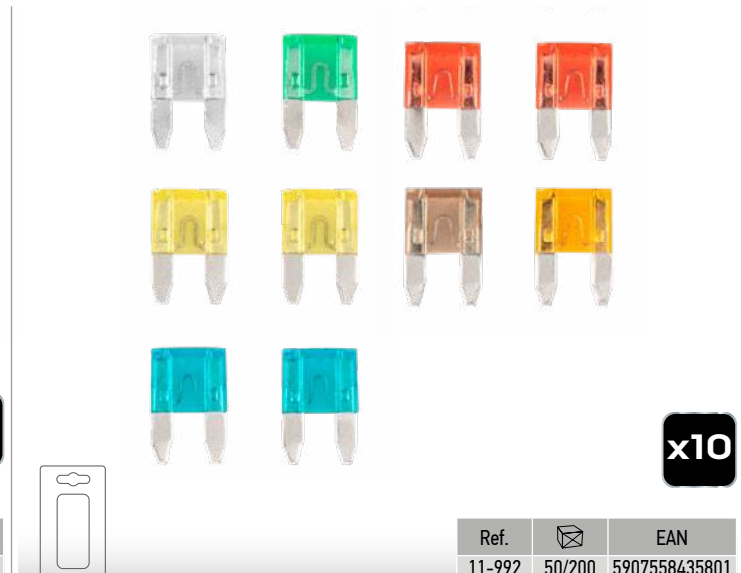

Opaski zaciskowe

Band clips / Klemmschellen / Хомутки стяжные / Хомуты стяжные / Kábelkötegelő / Cleme conexiune / Hadicové pásky / Fixačné pásky / PVC vezice / Užspaudėjas / Savilcēji / Rihmaklamber / PVC vezice / Κολλήρα σύσφιξης / Fascette per cavi / Cintas p. gramppear / Bride de serrage / Klembanden



Ref.	W [mm]	L [mm]	N	📦	EAN
01-620	2.5	80	100	0/500	5907558473391
01-621	2.5	100	100	0/500	5907558473407
01-622	2.5	150	100	0/250	5907558473414
01-623	2.5	200	20	0/625	5907558473421
01-624	2.5	200	100	0/250	5907558473438
01-625	3.6	150	20	0/625	5907558473445
01-626	3.6	150	100	0/125	5907558473452
01-627	3.6	200	20	0/500	5907558473469
01-628	3.6	200	100	0/125	5907558473476
01-629	3.6	300	20	0/250	5907558473483
01-630	3.6	300	100	0/100	5907558473490
01-631	4.8	150	100	0/100	5907558473506
01-632	4.8	200	20	0/250	5907558473513
01-633	4.8	200	100	0/100	5907558473520
01-634	4.8	300	20	0/250	5907558473537
01-635	4.8	300	100	0/60	5907558473544
01-636	4.8	370	50	0/100	5907558473551
01-637	4.8	450	50	0/100	5907558473568
01-638	7.6	200	50	0/100	5907558473575
01-639	7.6	300	50	0/50	5907558473582
01-640	7.6	400	50	0/50	5907558473599
01-641	7.6	500	50	0/50	5907558473605
01-642	9.0	400	50	0/50	5907558473612
01-643	9.0	550	50	0/50	5907558473629
01-644	9.0	650	50	0/50	5907558473636
01-645	12.0	700	50	0/25	5907558473643

Ref.	W [mm]	L [mm]	N	📦	EAN
01-646	2.5	80	100	0/500	5907558473650
01-647	2.5	100	100	0/500	5907558473667
01-648	2.5	150	100	0/250	5907558473674
01-649	2.5	200	20	0/625	5907558473681
01-650	2.5	200	100	0/250	5907558473698
01-651	3.6	150	20	0/625	5907558473704
01-652	3.6	150	100	0/125	5907558473711
01-653	3.6	200	20	0/500	5907558473728
01-654	3.6	200	100	0/125	5907558473735
01-655	3.6	300	20	0/250	5907558473742
01-656	3.6	300	100	0/100	5907558473759
01-657	4.8	150	100	0/100	5907558473766
01-658	4.8	200	20	0/250	5907558473773
01-659	4.8	200	100	0/100	5907558473780
01-660	4.8	300	20	0/250	5907558473797
01-661	4.8	300	100	0/60	5907558473803
01-662	4.8	370	50	0/100	5907558473810
01-663	4.8	450	50	0/100	5907558473827
01-664	7.6	200	50	0/100	5907558473834
01-665	7.6	300	50	0/50	5907558473841
01-666	7.6	400	50	0/50	5907558473858
01-667	7.6	500	50	0/50	5907558473865
01-668	9.0	400	50	0/50	5907558473872
01-669	9.0	550	50	0/50	5907558473889
01-670	9.0	650	50	0/50	5907558473896
01-671	12.0	700	50	0/25	5907558473902

Opaski zaciskowe

Band clips / Klemmschellen / Хомутки стяжные / Хомуты стяжные / Kábelkötegelő / Cleme conexiune / Hadicové pásky / Fixačné pásky / PVC vezice / Užspauđejas / Savilcēji / Rihmaklamber / PVC vezice / Κολλάρα σύσφιξης / Fascette per cavi / Cintas p. grampear / Bride de serrage / Klembanden



Ref.	☒	EAN
01-672	0/250	5907558473919

Taśma naprawcza

Repair tape / Ремонтная лента / Ремонтна стрічка / Javítószalag / Repararea benzii / Páska opravná / Opravná páska



Ref.	W [mm]	L [m]	☒	EAN
56-040	48	20	0/24	5907558446463

Pistolet do opasek zaciskowych

Cable tie gun / Anziehpietole / Стяжной пистолет / Пистолет для краваток / Meghúzó pisztoly / Pistol cu cravată / Kravatová piestole / Kravatová pištol / Pištola za kravate / Kaklarsaičio pistoletas / Kaklasaites pistole / Kaabli sidumipüstol / Пистолет за кабелни връзки / Pištolj za vezivanje kabela / Пистоль за везивање каблова / Πιστόλι γραβάτας / Pistola de atar / Pistola per cravatta / Pistola de amarrar / Pistolet à cravate / Spanpistol



Ref.	☒	EAN
01-615	0/50	5907558495386

Taśma izolacyjna

Insulating tape / Isolierband / Лента изоляционная / Стрічка ізоляційна / Szigetelőszalag / Banda izolatoare / Izolační páska / Páska izolačná / Izolacijski trak / Izoliravimo juosta / Izolācijas lentā / Isoleerteip / Izolir traka / Ταπία μόνωσης / Nastro isolante / Fita de isolação / Bande isolante / Isolatieband



Ref.	W [mm]	L [m]	kolor	☒	EAN
01-526	15	10	■	0/500	5907558439311



CHEMIA MOTORYZACYJNA

automotive chemicals автотомобільна хімія



Pasta želowa do mycia rąk usuwa trudne zabrudzenia

/ Gel paste for cleaning hands of persistent dirt / Gel-Handwaschpaste, entfernt hartnäckigen Schmutz / гелевая паста для мытья рук удаляет сильные загрязнения / гелева паста для миття рук видаляє складні забруднення / A zselé formájú kézmosó paszta eltávolítja a makacs szennyeződéseket / Pasta-gel pentru spălarea mâinilor îndepărtează murdăria persistentă / Gelová pasta na mytí rukou odstraňuje odolné nečistoty / Gélová pasta na umývanie rúk odstraňuje silné znečistenie / Gel pasta za umivanje rok odstranjuje trdovratne madeže / Geliné pasta rankoms plauti pašalina sunkiai įveikiamus nešvarumus / Gela pasta roku mazgāšanai noņem stiprus netīrumus / Geeljas kätepesupasta eemaldab ka tugeva määrdumise / гел-паста за измиване на ръце за отстраняване на силни замърсявания / Pasta u gelu za pranje ruka, uklanja tvrdokorna zaprljanja / Pasta u gelu za uklanjanje tvrdokornih zaprljanja / πάστα τζελ για το πλύσιμο των χεριών αφαιρεί δύσκολή βρωμιά / Pasta gel lavamanos para eliminar la suciedad persistente / Una pasta gel lavamani le sporcizie difficili da rimuovere / Pasta de gel para lavar mãos que remove a sujeira difícil / Pâte gel pour le lavage des mains ; élimine les saletés tenaces / De gel pasta voor het wassen van de handen die hardnekkig vuil verwijdert



500g

Ref.	Color	☒	EAN
10-401	Orange	1/0	5907558467154
10-403	Yellow	1/0	5907558467178
10-405	White	1/0	5907558467192



4.0L

Ref.	Color	☒	EAN
10-402	Orange	1/0	5907558467161
10-404	Yellow	1/0	5907558467185
10-406	White	1/0	5907558467208

Uniwersalne chusteczki czyszczące do rąk

All-purpose hand wipes / Allzweck-Händereinigungstücher / Универсальные чистящие салфетки для рук / Универсални серветки для очищения рук / Univerzális kéztisztító törölkendők / Şervețele universale pentru curățarea mâinilor / Univerzálni ubrusky na čistění rukou / Univerzálne utierky na čistenie rúk / Univerzalni čistilni robčki za roke / Universalios rankų valymo servetėlės / Univeršalas roku tīršanas salvetes / Universaalsed kätepuhastusrätikud / Универсални кърпички за почистване на ръце / Univerzalne maramice za pranje ruku / Μαντηλάκια καθαρισμού χεριών γενικής χρήσεως / Toallitas lavamanos multiuso / Fazzoletti universali per pulire le mani / Toalhetes universais para limpar mãos / Lingettes nettoyantes universelles pour les mains / Universele reinigingsdoekjes voor de handen

Chusteczki ze ścierniwem do mycia rąk oraz czyszczenia powierzchni i narzędzi

Abrasive grit wipes for cleaning hands, surfaces and tools. / Scheuertücher zum Händewaschen und Reinigen von Oberflächen und Werkzeugen / Абразивные салфетки для мытья рук, очистки поверхностей и инструментов / Абразивни серветки для миття рук, очищення поверхонь та інструментів / Súrolószeres törölkendők kézmosáshoz, valamint felületek és szerszámok makacs szennyeződéseitől való megtisztításához / şervețele abrazive pentru spălarea mâinilor și curățarea suprafețelor și a uneltelor / abrazivni ubrusky na mytí rukou a čistění povrchů a nářadí / Utierky s abrazívnou zložkou na čistenie rúk a čistenie povrchov a nástrojov / čistilni brusilni robčki za čiščenje rok, površin in orodij / Abrazivines servetėlės rankoms plauti ir paviršiams bei įrankiams valyti / Abrazivas salvetes roku tīršanai, kā arī virsmu un instrumentu tīršanai / Abrazivainega rätikud käte pesemiseks ning pindade ja tööriistade puhastamiseks. / Кърпички с абразив за измиване на ръце и почистване на повърхности и инструменти. / maramice sa abrazivom za pranje ruku i čišćenje površina i alata / maramice sa abrazivom za pranje ruka i čišćenje površina i alata. / λειαντικά μαντηλάκια για πλύσιμο χεριών και καθαρισμό επιφανειών και εργαλείων / toallitas con abrasivos para lavar las manos y limpiar las superficies y herramientas / fazzoletti con abrasivo per lavare le mani e pulire le superfici e gli strumenti di lavoro / Toalhetes com abrasivo para lavar mãos e limpar superfícies e ferramentas / lingettes abrasives pour le lavage des mains et le nettoyage de surfaces et d'outils. / schurende doekjes voor het wassen van de handen en het reinigen van oppervlakken en gereedschap



Ref.	☒	EAN
10-407	1/0	5907558467215



Ref.	☒	EAN
10-408	1/0	5907558467222

NARZĘDZIA I AKCESORIA MOTOCYKLOWE

motorcycle
tools and accessories

Інструменти та аксесуари для
МОТОЦИКЛІВ

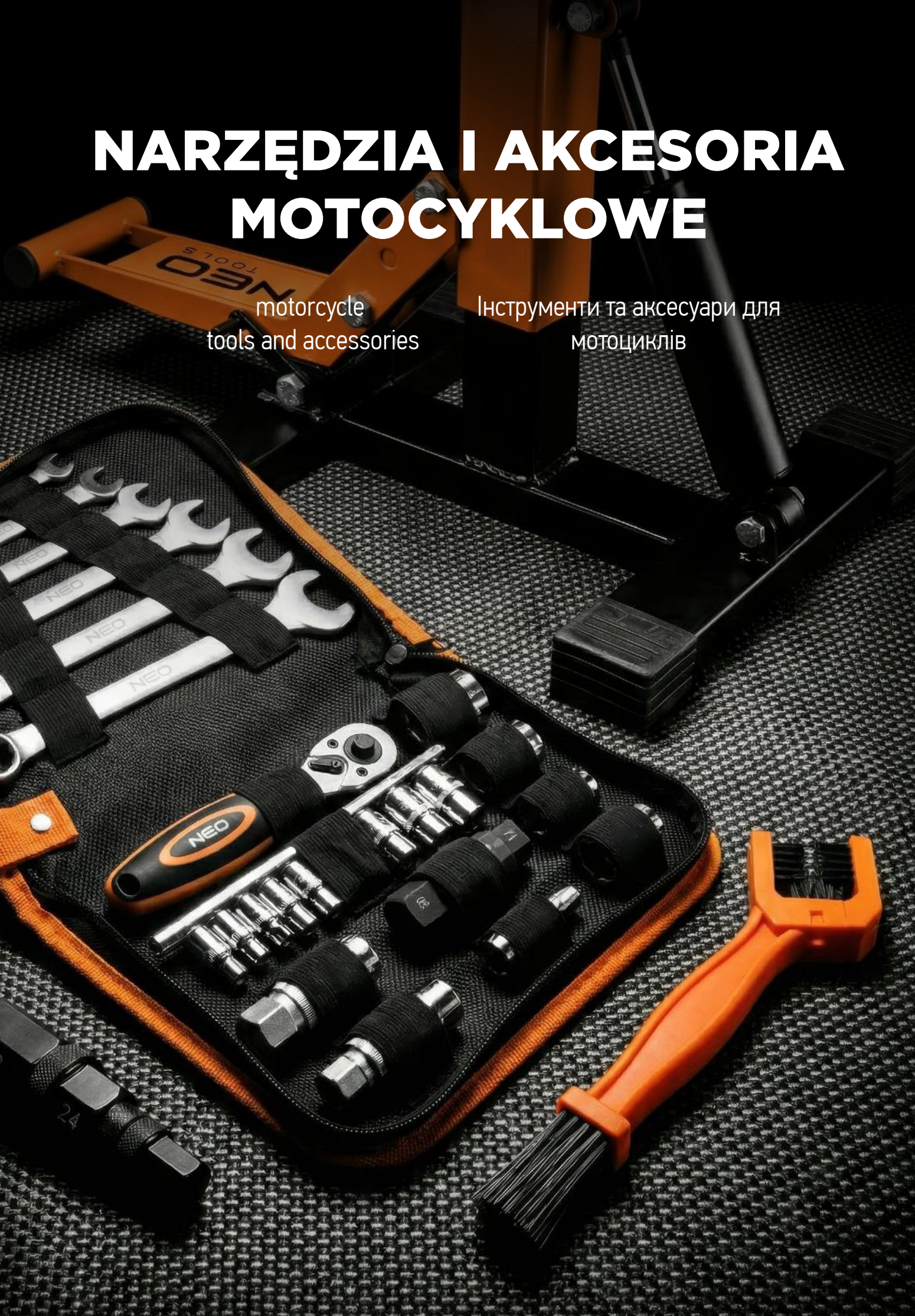

Pokrowiec oddychający na motocykl / skuter

Breathable motorcycle/scooter cover / Atmungsaktive Motorrad-/Rollerabdeckung / Дышащий чехол для мотоцикла/скутера / Дыхающий чехол для мотоцикла/скутера / Lélegző motorkerékpár/robogó huzat / Acoperire respirabilă pentru motocicletă/scooter / Prodyšný obal na motocykl/skútr / Priedušný obal na motocykel/skúter / Dihajoča prevleka za motorno kolo/skuter / Kvėpuojantis motociklo / motorlerio dangtis / Elprojošs motocikla/skūtera pārsegs / Дышащо покрывало за мотоциклет/скутер / Αναπνεύσιμο κάλυμμα μοτοσικλέτας/μοτοσκούτερ / Copri moto/scooter traspirante / Cobertura respirável de motocicleta/scooter / Funda transpirable para moto/scooter / Housse de moto/scooter respirante / Ademende motorfiets-/scooterhoes



220x
105x
130 cm

waterproof
breathable

black
flat fabric

Ref.	☒	EAN
10-472	0/1	5907558471090

Kuweta na narzędzia, silikonowa

Silicone screw cell small / Werkzeugablage, Silikon / Лоток для инструментов, силиконовый / Лоток для инструментов, силиконовый / Szerszámtálcá, szilikon / Tavă pentru scule, silicon / Zásobník na nářadí, silikonový / Zásobník na nářadí, silikonový / Pladenj za orodje, silikon / Įrankių dėklas, silikoninis / Instrumentu paliktinis, silikona / Тава за инструменти, силикон / Δίσκος εργαλείων, σιλικόνη / Vaschetta per attrezzi, silicone / Bandeja de herramientas, silicona / Plateau à outils, en silicone / Bandeja de ferramentas, silicone / Gereedschapsbakje, silicone /

MADE OF
STRONG
TPR
SILICONE



Ref.	Info [mm]	☒	EAN
10-480	275 x 145 x 25	1/20	5907558471137
10-481	257 x 232 x 25	1/20	5907558471144
10-482	540 x 290 x 35	1/10	5907558471151

Pokrowiec na motocykl / skuter

Motorcycle / scooter cover / Motorrad-/Rollerabdeckung / Чохол для мотоцикла/скутера / Чехол для мотоцикла/скутера / Motorkerékpár/robogó védőhuzat / Husá pentru motocicletă/scooter / Potah na motorku/skútr / Poťah na motorku/skúter / Prevleka za motorno kolo/skuter / Motociklo / motorlerio dangtis / Motocikla/skūtera pārsegs / Покривало за мотоциклет/скутер / Κάλυμμα μοτοσικλέτας/μοτοσκούτερ / Copertura per moto/scooter / Funda para moto/scooter / Housse de moto/scooter / Cobertura de motocicleta/scooter / Motorfiets-/scooterhoes

246
x104
x127cm

190 T
polyester
taffeta

waterproof
resistant
to UV150°



Ref.	☒	EAN
10-473	0/1	5907558471106

Mata środowiskowa

Environmental mat / Umweltmatte / экологический коврик / экологічний мат / Környezetvédelmi szőnyeg / Covoraş de mediu / Environmentalní podložka / Environmentalna podložka / Okoljska podloga / Aplinkos klimėlis / Vides paklājīņš / Keskonna matt / Экологична мат / Ekološki mat / Екологіка простурка / περιβαλλοντικό χαλάκι / Alfombra ambiental / Tappetino ambientale / Tapete ambiental / Tapis environnemental / Milieumat

100x
200CM

POLYESTER
/PVC

5.5kg





Ref.	☒	EAN
10-600	0/4	5907558499865

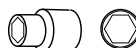

Zestaw narzędzi

Tool and socket set / Werkzeugsatz / Набор инструментов / Инструмент з насадками, набір / Szerszámkészlet / Set scule de grădină / Sada nářadí / Súprava náradia kombi / Garnitura orodij / Įrankių komplektas / Instrumentu komplekts / Tööriistade ja padrunite komplekt / Комплект инструментов / Set alata / Gedora set / Συλλογή εργαλείων / Juego de herramientas / Set di attrezzi / Kit de ferramentas / Jeu d'outils / Gereedschapsset

 3/8" - 15, 16, 19, 22 mm

 3/8" - E10, E11, E12, E14
1/4" - E4, E5, E6, E7, E8

 3/8" - 14, 16 mm

 1/4" & 3/8" - 72T

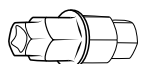
 4 in 1: - 17, 19, 22, 24 mm

 3/8" - T55

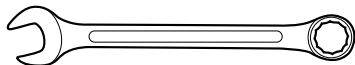
 8, 10, 12, 14, 16, 17 mm



CrV
steel

x25

1/4"

3/8"

Ref.		EAN
10-500	1/10	5907558466317

Narzędzie do osi motocyklowych

Motorcycle axle tool / Werkzeug für Motorrad-Achsen / Инструмент для оси мотоцикла / Инструмент для осей мотоцикла / Szerszám motorkerékpár tengelyekhez / Cheie hexagonală ax roata motocicletă / Přípravek na osy motocyklů / Nářadie na motocyklové osi / Orodje za osi motociklov / Motociklo ašij įrankis / Motocikla ass riki trīs vienā / Mootorratta-teljetoõriistad / Инструмент за мотоциклетни осу / Alat za osovine motocikla / Alat za osovine motocikla / Herramienta de eje de motocicleta / Utensile per assi delle moto / Ferramenta para eixos de motocicleta / Outil pour axe de moteur / As Inbus Zeskant voor motorfietsen

6in1



CrV
steel

12mm
FOR:
KTM
front axis

19mm
FOR:
YAMAHA

17mm
FOR:
BENELLI

22mm
FOR:
KAWASAKI

14mm
FOR:
YAMAHA
XT660Z
KAWASAKI
ER-5N
VERSYS
XT660Z

24mm
FOR:
BMW
HONDA
SUZUKI

Ref.		EAN
10-501	1/72	5907558466324

4in1



CrV
steel

17mm

19mm

22mm

24mm

Ref.		EAN
10-502	1/72	5907558466331

3in1



carbon
steel

19
mm

22
mm

24
mm

Ref.		EAN
10-503	1/72	5907558466348

Wskaźnik zegarowy GMP

GMP dial indicator / GMP-Uhranzeige / Индикатор часов GMP / Годи́нниковый инди́катор GMP / GMP órás indikátor / Indicator cadran GMP / Učhlykoměr pro nastavení předstihu / Hodinový ukazovateľ GMP / Merilna ura GMP / Laikrodinis viršutinio mirties taško indikatorius / GMP pulksteņa indikators / GMP-numbrinādik / GMP часовников индикатор / Satni indikator GMP / Satni indikator GMP / Indicador de dial GMP / Comparatore GMP / Relógio comparador GMP / Indicateur à cadran GMP / GMP wijzerplaat indicator

CrV
steel



Ref.		EAN
10-504	1/10	5907558466355



Zestaw narzędzi do zakuwania i rozkuwania łańcucha

Chain crimping and uncrimping set / Set zum Crimpen und Entcrimpen von Ketten / Набор для обжима и разжима цепи / Набор для обжиму та розжиму ланцюга / Láncfűző és -bontó készlet / Set de sertizare și degajare a lanțului / Sada na krimpování a rozplétání řetězu / Súprava na krimpovanie a odskrutkovanie reťaze / Komplet za stiskanje in odpenjanje verige / Grandinių užspaudimo ir atspaudimo rinkinys / Kėdes presėšanas un atpresėšanas komplekts / Tööriistade komplekt keti kokkupressimiseks ja katkestamiseks / Комплект за пресоване и разпресоване на верици / Set alata za presovanje i lomljenje lanca / Set алата за пресовање и ломљење ланца / Set di crimpaggio e disincastro per catene / Conjunto de engaste e desengordadura de correntes / Kit de sertissage et de dessertissage de chaîne / Kettingkrimp- en ontcrimpset



INCLUDES PINS SIZES:
3, 4, 5 mm

FOR CHAIN SIZES:
520, 525
530, 532

Ref.	📦	EAN
10-505	1/10	5907558466362

Zestaw narzędzi do cylinderków hamulcowych

Tool set for brake cylinders / Werkzeugsatz für Bremszylinder / Набор инструментов для тормозных цилиндров / Набор інструментів для гальмюючих циліндрів / Szerszámkészlet fékhengerekhez / Set de unelte pentru cilindri de frână / Sada náradí na brzdové válce / Súprava nástrojov na brzdové valce / Komplet orodja za zavorne cilindre / Stabdžių cilindų įrankių rinkinys / Instrumentu komplekts bremžu cilindriem / Tööriistakomplekt pidurisilindrite jaoks / Комплект інструменти за спирачни цилиндри / Set alata za kočione cilindre / Комплект алата за kočione цилиндри / Juego de herramientas para cilindros de freno / Set di attrezzi per cilindri dei freni / Conjunto de ferramentas para cilindros de travão / Jeu d'outils pour cylindres de frein / Gereedschapsset voor remcilindersicator



12
adapters

Ø
19-30
mm

Ref.	📦	EAN
10-506	1/5	5907558466379

Narzędzie do rozkuwania łańcucha

Motorcycle chain cutter / Motorrad-Kettenschneider / Мотоциклетная цепь / Розривач ланцюга мотоцикла / Motorkerékrár láncvágó / Mašinã de tăiat lanțuri de motocicletã / Motocyklový řezák řetězu / Reťazový rezač na motocykel / Rezalnik verige motornega kolesa / Motociklo grandinės pjoviklis / Motocikla kėdes griežys / Mootorratta ketilõikur / Резец за мотоциклетна верица / Rezač lanca motocikla / Rezač lanca motocikla / Κόφτης αλυσίδας μοτοσυκλέτας / Cortacadenas para motos / Tagliacatena per moto / Corrente de motocicleta cutter / Coupe-chaîne de moto / Kettingsnijder voor motorfijetsen



FOR CHAIN SIZES:
415, 420
423, 428

Ref.	📦	EAN
10-510	1/50	5907558466416

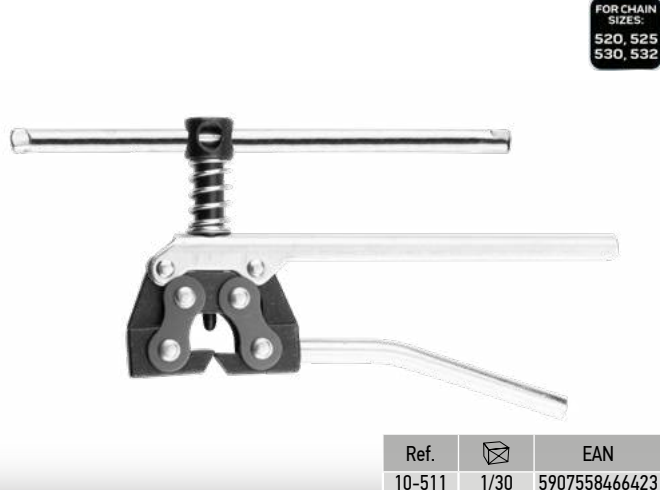

FOR CHAIN SIZES:
520, 525
530, 532

Ref.	📦	EAN
10-511	1/30	5907558466423

Nylonowa szczotka do czyszczenia łańcucha

Chain cleaning nylon brush / Nylon-Bürste für die Reinigung der Kette / Нейлоновая щетка для очистки цепи / Нейлонова щітка для чищення ланцюга / Nylon láncisztító kefe / Perie de nylon de curățat lanțuri / Nylonový kartáč na čistení řetězu / Nylonová kefa na čistenie reťaze / Najlonska krtača za čiščenje verige / Nailoninis grandinės valdymo šepetys / Neilona birste kėdes tirišanai / Nailonist ketipuhastushari / Нейлонова четка за почистване на верица / Najlonska četka za čiščenje lanca / Βούρτσκα καθαρισμού αλυσίδας από νάιλον / Cepillo de nylon para limpiar cadenas / Spazzola in nylon per la pulizia di catene / Escova de nylon para limpeza de correntes / Brosse pour chaîne en nylon / Nylonborstel voor het reinigen van kettingen



Ref.	📦	EAN
10-509	1/100	5907558466409

Szczypce do wyciągania tłoczków hamulcowych

Brake piston retractors / Zange für das Herausnehmen der Bremskolben / Съемник для тормозных цилиндров / Плоскозубци для зняття гальмюючих поршнів / Fékdugattyúk kihúzására szolgáló fogó / Clește pentru extragerea pistoanelor de frână / Kleště na vytažení brzdových pístů / Klešte na vyťahovanie brzdových piestov / Klešče za odstranjevanje zavornih batnic / Stabdžių stūmoklių traukimo žnyplės / Knaibles bremžu virzuļu nopemšanai / Pidurkolbide eemaldamise tangid / Клепци за изваждане на спирачни бутала / Klijesta za skidanja klipova kočnica / Klešta za skidanje klipova kočnica / Πένσα ανοίγματος εμβόλων φρένων / Pinzas para retirar pistones de freno / Pinze per l'estrazione dei pistoncini dei freni / Alicates de remoção do pistão do travão / Pinceaux pour retirer les pistons de freins / Remzuiger-demontagetang



A3
steel

Ø
18-44
mm

Ref.	📦	EAN
10-507	1/20	5907558466386

Zestaw narzędzi do montażu i demontażu łożysk główek ramy w motocyklach

Motorbike head frame bearing installation and removal tool kit / Werkzeugsatz für die Montage und Demontage von Motorradkopfagern / Набор инструментов для установки и снятия подшипников головной рамы мотоцикла / Набор інструментів для встановлення та зняття підшипника головної рами мотоцикла / Motorkerékpár fejcsapágy szerelési és eltávolítási szerszámkészlet / Kit de instrumente de instalare și demontare a rulmenților pentru montarea și demontarea cadrului capului motocicletei / Sada nástrojů pro montáž a demontáž ložisek rámu hlavy motocyklu / Súprava nástrojov na montáž a demontáž ložiska rámu hlavy motocykla / Komplet orodij za namestitve in odstranitev ležaja okvirja glave motornega kolesa / Motociklo galvos rėmo guolių montavimo ir nuėmimo įrankių rinkinys / Motocikla galvas rāmjā gulņņu uzstādīšanas un noņemšanas instrumentu komplekts / Tööriistade komplekt mootorrattaste roolipea laagrite paigaldamiseks ja eemaldamiseks / Комплект инструменти за монтаж и демонтаж на лагер на рамата на мотоциклета / Set alata za montažu i skidanje ležajeva glave upravljača na motociklima / Сет алата за уградњу и уклањање лежајева главе управљача на мотоциклима / Kit εργαλείων εγκατάστασης και αφαίρεσης ρουλεμάν πλαίσιοι κεφαλής μοτοσικλέτας / Kit de herramientas para la instalación y el desmontaje de los rodamientos del cuadro de la moto / Kit di strumenti per l'installazione e la rimozione dei cuscinetti del telaio della moto / Kit de ferramentas de instalação e remoção de apoios de cabeça de motocicleta / Kit d'outils de montage et de démontage des roulements du cadre de la tête de la moto / Motorfiets hoofdframe lager installatie en verwijdering gereedschapsset



TYPE
T
HANDLE

7
psc
adapters

DIAMETER
SIZES:
32-46
mm

Ref.	📦	EAN
10-588	1/2	5907558466966

Wyważarka statyczna do kół motocyklowych

Static motorcycle wheel balancer / Statische Motorrad-Raduswuchtmaschine / Статический балансирующий колес мотоцикла / Балансир статичний для коліс мотоцикла / Statikus motorkerékpárkerékgyensúlyozó eszköz / Echilibrator de roți statice pentru motocicletele / Statická vyvažovačka kol motocyklu / Statická vyvažovačka kolies motocykla / Statična izravnalna naprava za kolesa motornih koles / Statinis motociklo ratų balansavimo įtaisai / Statiskais motocikla riteņu balansieris / Statiline tasakaalustaja mootorrattaste jaoks / Статичен балансир за колела на мотоциклет / Statički uređaj za balansiranje kotača motocikla / Статични баланс точкова за точкове мотоцикала / Στατική εξισορρόπηση για τροχοίς μοτοσικλετών / Equilibrador estático de ruedas de moto / Equilibratore statico della ruota della moto / Roda de motocicleta estática balancer / Equilibreur statique de roue de motocyclette / Statische motorfiets wiel balancer



max
21"

14-28
mm
AXIS

3,9
kg

Ref.	📦	EAN
10-590	0/1	5907558466980

Mobilny podnośnik hydrauliczny do quadów i motocykli

Mobile hydraulic jack for quads and motorbikes / Mobilier hydraulischer Wagenheber für Quads und Motorräder / Мобильный гидравлический домкрат для квадроциклов и мотоциклов / Мобільний гідролічний домкрат для квадроциклів та мотоциклів / Mobil hidraulikus emelő quadokhoz és motorkerékpárokhoz / Cric hidraulic mobil pentru quad-uri și motocicletele / Mobilni hidraulički zvedák pro čtyřkolky a motocykly / Mobilný hydraulický zdvihač pre štvorkolky a motocykle / Mobilni hidraulični dvigalo za štirikolesnike in motorna kolesa / Mobilus hidraulinis keltuvas keturračiams ir motociklams / Mobilais hidrauliskais domkrats kvadracikiem un motocikliem / Mobiilne hüdruuline tungraud nelikutele ja mootorrattastele / Мобилен хидравлически повдигач за четурколки и мотоциклети / Mobilna hidraulička dizalica za quadove i motocikle / Мобилна хидраулична дизалица за квад и мотоцикле / Κινητός υδραυλικός γρύλος για quads και μοτοσικλές / Gato hidráulico móvil para quads y motos / Martinetto idraulico mobile per quad e moto / Macaco hidráulico móvel para quads e motocicletas / Cric hydraulique mobile pour quads et motos / Mobile hydraulische krik voor quads en motoren

up to
680kg

27
kg

MAX
375
mm
MIN
115
mm
H



Ref.	📦	EAN
10-596	0/1	5907558467048

Podnośnik pod motocykle off-road, cross, enduro

Lift for off-road, cross, enduro motorbikes / Hebebühne für Off-Road-, Cross- und Enduro-Motorräder / Подъемник для внедорожных, кроссовых, эндуро мотоциклов / Підйомник для позашляхових, кроссових, эндуро мотоциклів / Emelő terep, cross, enduro motorkerékpárokhoz / Lift pentru motocicletele off-road, cross, enduro / Zvedák pro terénní, crossové a enduro motocykly / Zdvihač pre terénne, crossové a enduro motocykle / Dvigalo za terenska, cross in enduro motorna kolesa / Keltuvas visureigiams, krosiniams, enduro motociklams / Pacēlājs bezceļu, krosa, enduro motocikliem / Tõstuk off-road, cross, enduro mootorrattastele / Подъемник за офроуд, крос и эндуро мотоциклети / Lift za terenske, cross, enduro motocikle / Лифт за теренске, крос, эндуро мотоцикле / Ανελκυστήρας για μοτοσικλές εκτός δρόμου, cross, enduro / Elevador para motos off-road, cross, enduro / Sollevatore per moto off-road, cross, enduro / Elevador para motos de todo-o-terreno, cross e enduro / Élévateur pour motos tout-terrain, cross, enduro / Lift voor off-road-, cross- en enduromotoren



up to
200kg

MAX
460
mm
MIN
250
mm
H

11
kg

Ref.	📦	EAN
10-598		5907558477214

Stojak motocyklowy na tylne koło

Rear wheel motorbike stand / Hinterrad-Motorradständer / Подставка для мотоцикла с задним колесом / Подставка для мотоцикла с задним колесом / Hátsó kerék motorkerékpár állvány / Support pentru motocicletă cu roți spate / Stojan na zadní kolo motocyklu / Stojan na zadné koleso motocykla / Stojalo za zadnje kolo motornega kolesa / Galinio rato motociklo stovas / Aizmugurējā riteņa motocikla statīvs / Tagumise ratta mootorratta statiiv / Стойка за мотоциклет със задно колело / Moto stalak za stražnji kotač / Сталак за мотоцикл за задњи точак / Βάση μοτοσικλέτας πίσω τροχού / Caballete rueda trasera moto / Cavalletto per moto con ruota posteriore / Suporte de roda traseira para motocicletas / Béquille de moto à roue arrière / Achterwiel motorstandaard



Ref.	📦	EAN
10-604		5907558477221

Stojak motocyklowy pod przednie koło

Motorcycle front wheel stand / Vorderradständer für Motorräder / Стойка переднего колеса мотоцикла / Подставка для передних колес мотоцикла / Motorkerékpár első kerékállvány / Support pentru roata din față a motocicletei / Stojan na přední kolo motocyklu / Stojan na predné koleso motocykla / Stojalo za sprednje kolo motornega kolesa / Priekinis motociklo ratu stovas / Motocikla priekšējo riteņu statīvs / Mootorratta esiratta statiiv / Предна стойка за колело на мотоциклет / Stalak za motocikl ispod prednjeg kotača / Сталак за мотоцикле испод предњег точна / Στήριγμα μπροστινού τροχού μοτοσικλέτας / Caballete de rueda delantera de moto / Cavalletto anteriore per moto / Suporte de roda dianteira da motocicleta / Béquille de roue avant de motocyclette / Motorfiets voorwielstandaard



Ref.	📦	EAN
10-602	0/1	5907558467109

Przyrząd do demontażu i montażu kół motocyklowych

Tool for dismounting and mounting motorbike wheels / Werkzeug für die Demontage und Montage von Motorradrädern / Инструмент для демонтажа и монтажа колес мотоцикла / Инструмент для демонтажу и монтажу мотоциклетних колес / Szerszám motorkerékpár kerekek le- és felszereléséhez / Unealtă pentru demontarea și montarea roților de motocicletă / Nástroj na demontáž a montáž kol motocyklu / Nástroj na demontáž a montáž kolies motocykla / Orodje za demontažo in montažo koles motornega kolesa / Įrankis motociklo ratams išmontuoti ir sumontuoti / Instruments motociklu riteņu demontāžai un montāžai / Tööriist mootorratta rataste lahtivõtmiseks ja kokkupanemiseks / Инструмент за демонтиране и монтиране на колела на мотоциклетни / Alat za demontažu i montažu kotača motocikla / Alat за демонтажу и монтажу точкова мотоцикла / Εργαλείο για την αποσυναρμολόγηση και τοποθέτηση τροχών μοτοσικλέτας / Herramienta para desmontar y montar las ruedas de la moto / Attrezzo per smontare e montare le ruote della moto / Ferramenta para desmontagem e montagem de rodas de motos / Outil pour le démontage et le montage des roues de motos / Gereedschap voor het demonteren en monteren van motorfietswielen



Ref.	📦	EAN
10-606	0/1	5907558467147



NARZĘDZIA I AKCESORIA PNEUMATYCZNE

pneumatic
tools and accessories

пневматичні інструменти та
аксесуари

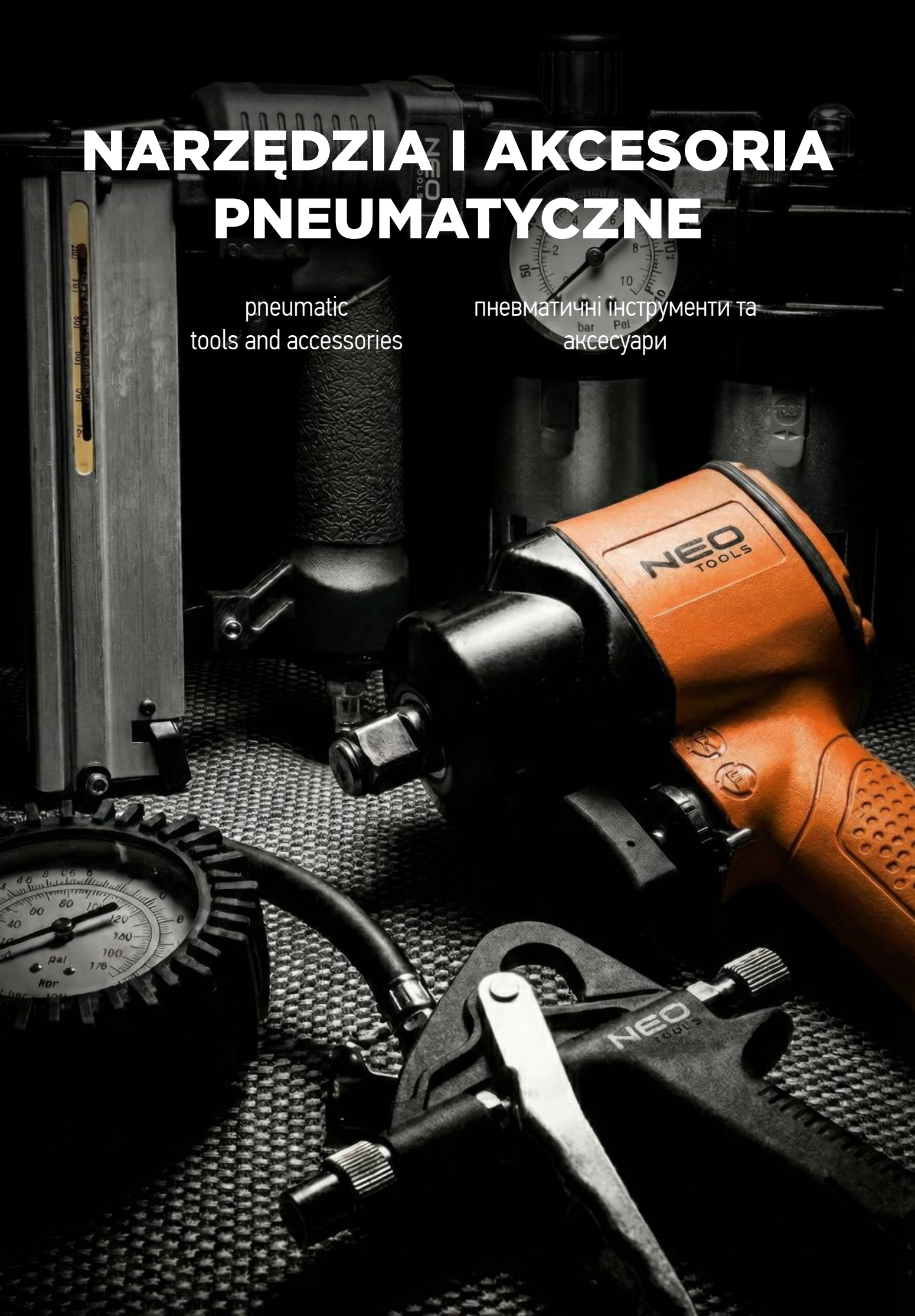

Klucz pneumatyczny udarowy

Pneumatic impact wrench / Pressluftschlagschlüssel / Ключ пневматический ударный / Ключ пневматичний ударний / Pneumatikus ütvecsavarozó / cheie pneumatică de lovit / Pneumatický nárazový klíč / Pneumatická rázová utáhovačka / Pnevmatiski udarni vijac / Pneumatinis, smūginis veržliaraktis / Pnevmatiskā sietena pistole / Pnevmatiline löök-mutrivõti / Гацькоэрт пневматычн / Pnevmatiski Ključ udarni / Pnevmatiski ključ / Σφυρί αέρος αναστρέφόμενο / Llave de impacto neumática / Chiave pneumatica a percussione / Chave pneumática de impacto / Clef pneumatique à chocs / Pneumatisch slagsleutel



1300 Nm

- 1/2"
- TWIN HAMMER CLUTCH
- 7000 rpm
- 1/4"
- 10mm
- 128 l/min
- MAX 6.2 BAR
- L/R

Ref.	⊠	EAN
14-002	1/6	5907558442533



2000 Nm

- 3/4"
- TWIN HAMMER CLUTCH
- 5500 rpm
- 3/8"
- 10mm
- 227 l/min
- MAX 6.2 BAR
- L/R

Ref.	⊠	EAN
14-008	1/4	5907558442564



680 Nm

- 1/2"
- JUMBO CLUTCH
- 10000 rpm
- 1/4"
- 10mm
- 113 l/min
- MAX 6.2 BAR
- L/R

Ref.	⊠	EAN
14-006	1/6	5907558442557



680 Nm

- 1/2"
- 7500 rpm
- 1/4"
- 10mm
- 198 l/min
- MAX 6.2 BAR
- L/R

Ref.	⊠	EAN
14-001	1/6	5906692026890



610 Nm

- 1/2"
- 8000 rpm
- 1/4"
- 156 l/min
- MAX 6.2 BAR

Ref.	⊠	EAN
14-005	1/10	5906692026883



800 Nm

- 1/2"
- 7000 rpm
- 1/4"
- 20mm
- 141 l/min
- MAX 6.2 BAR

Ref.	⊠	EAN
14-003	1/6	5906692026876



4390 Nm

- 1"
- 1/2"
- 52mm
- 3000 rpm
- 880 l/min
- WORKING PRESSURE 8-12 BAR
- L/R

Ref.	⊠	EAN
14-009	1/10	5906692026869



320 Nm

- 1/2"
- 7000 rpm
- 1/4"
- 141 l/min
- 10mm
- MAX 6.3 BAR
- L/R

1/2" - 9, 10, 11, 13, 14, 17, 19, 22, 24, 27 mm

Ref.	⊠	EAN
14-502	1/5	5907558444841

Klucz udarowy kątowy

Angle impact driver / Winkel-Schlag-Schlüssel / Ударный ключ / Ударний куттовий ключ / Ütvecsavarozó sarokkulcs / Cheie de impact unghiulara / Rázový rohový klíč / Uhlový rázový klíč / Kotni udarni ključ / Kampinis smūginis veržiasukis / Leņķveida triecienuzgriežņu atslēga / Nurga-lõõkvõti / Ёзлов ударен ключ / Udarni kutni ključ / Угаони ударни клjuč / Αεροκλειδί κρούσης / Llave de impacto angular / Chiave a percussione angolare / Chave de impacto angular / Clé à choc angulaire / Haakse slagmoersleutel



Ref.	☒	EAN
14-019	0/10	5907558469011

Szlifierka kąтова pneumatyczna

Angle pneumatic grinder / Пневматична кутова шлифовална машина / Polizor unghiular pneumatic / Pneumatikus sarokcsiszoló gép / Smerigliatrice angolare pneumatica / Meuleuse d'angle pneumaticque / Pneumatiská uhlová bruska / Pneumatiska kutna brusilica / Pneumatinis kampinis šlifukočlis / Pneumatiskā leņķa slīpmašīna / Pnevmatiski kutni brusilnik / Пневматичен ъзловашлиф / Pneumatiski Ugaon brusilica / Πνευματικός γωνιακός λειαντήρας / Pneumatische haakse slijper / Rebarbadora angular pneumática / Amoladora angular neumática / Pneumaatiline nurklühmasin



Ref.	☒	EAN
14-022	1/30	5906692026944

Szlifierka prosta pneumatyczna

Pneumatic straight grinder / Schleifmaschine gerade pneumatisch / Прямой пневматический шлифовальный аппарат / Шліфмашина пряма пневматична / Pneumatikus egyenes csiszológép / Polizor simplu pneumatic / Přímá pneumatická bruska / Pneumatická jednoduchá bruska / Pnevmatiski premi brusilnik / Pneumatinis, tiesinis šlifukočlis / Pneumatiska taisna slīpmašīna / Pneumaatiline lihtlühvija / Обикновен пневматичен шліф / Pneumatska jednostavna brusilica / Pneumatska prosta obična brusilica / Ευθύς λειαντήρας αέρος / Amoladora neumática recta / Smerigliatrice pneumatica dritta / Disco de limar reto pneumático / Meuleuse droite pneumaticque / Pneumatische rechte schuurmaschine



Ref.	☒	EAN
14-014	1/20	5907558442595



Ref.	☒	EAN
14-015	1/20	5906692026937

Klucz kątowy pneumatyczny

Pneumatic angle wrench / Winkelschlüssel pneumatisch / Ключ углової пневматический / Мутровверт куттовий пневматичний / Pneumatikus racsnis kulcs / Cheie unghiulară, pneumatică / Uhlový klíč pneumatický / Pneumatický uhlový klíč / Pnevmatiska raglja / Pneumatinis kampinis raktas / Pneumatiskā leņķu atslēga / Pneumaatiline nurkvõti / Ёзлов пневматичен ключ / Pneumatiski kutni ključ / Pneumatiski ugaoni ključ / Κλειδί γωνιακό αέρος / Llave articulada neumática / Chiave pneumatica angolare / Chave de canto pneumático / Clef d'angle pneumaticque / Pneumatisch haaksleutel



Ref.	☒	EAN
14-012	1/20	5907558442588



Ref.	☒	EAN
14-011	1/20	5906692026906

Szlfierka mimośrodowa pneumatyczna

Pneumatic orbital sander / Exzenterschleifer pneumatisch / Машина шлифовальная эксцентриковая пневматическая / Шліфмашинка эксцентрикова пневматична / Pneumatikus excenterscsiszoló / Polizor excentric, pneumatic / Pneumatická excentrická bruska / Pneumatická excentrická brúška / Pnevmatiski ekscentrični brusilnik / Pnevmatinis, ekscentrinis šlifuoškis / Pnevmatiska ekscentriská slípmošina / Pnevmaatiline eksstentriklivija / Пневматичен эксцентършлайф / Pnevmatiska ekscentarska brusilica / Pnevmatiska ekscentrična brusilica / Έκκεντρο τριβείο αέρος / Lijadora neumática excéntrica / Levigatrice rotoorbitale pneumatica / Disco de limar para excêntrico pneumática / Meuleuse excentrique pneumatique / Pneumatische excenter schuurmachine /

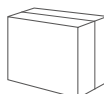

Ref.	☒	EAN
14-510	1/10	5907558446357



Ref.	☒	EAN
14-021	1/10	5906692026951



Ref.	☒	EAN
14-039	1/10	5906692026968



Ref.	☒	EAN
14-018	1/10	5907558442618

Szlfierka pneumatyczna kątowa

Pneumatic angle grinder / Pressluftwinkelschleifer / Машина шлифовальная угловая пневматическая / Шліфмашинка пневматична нарізна / Pneumatikus csiszoló / Mašina pneumatičá de šľefuit sub unghi / Pnevmatiski rezalnik / Pnevmatinis pjoviklis / Pnevmatiskais griezējs / Pnevmaatiline lõikur / Пневматичен фреза / Pnevmatiski rezáč / Pnevmatiska seckalica / Εργαλείο διακοπής αέρα / Cortador neumático / Troncatrice pneumatica / Cortador pneumático / Dispositif de coupe pneumatique / Pneumatische doorslijpmachine / Pneumatische versteckschuurmachine

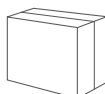

Ref.	☒	EAN
14-508	1/10	5907558444858

Przecinarka pneumatyczna

Air Cut-Off Tool / Pneumatisches Schneidegerät / Пневматический резак / Пневматичний різальний станок / Pneumatikus vágó / Mašina de tăiat pneumatica / Pneumatická řezačka / Pneumatická píla / Pnevmatiski rezalnik / Pnevmatinis pjoviklis / Pnevmatiskais griezējs / Pnevmaatiline lõikur / Пневматичен фреза / Pnevmatiski rezáč / Pnevmatiska seckalica / Εργαλείο διακοπής αέρα / Cortador neumático / Troncatrice pneumatica / Cortador pneumático / Dispositif de coupe pneumatique / Pneumatische doorslijpmachine



Ref.	☒	EAN
14-023	1/20	5906692026975

Wiertarka pneumatyczna

Pneumatic drill / Bohrmaschine pneumatisch / Дрель пневматическая / Дрель пневматичний / Pneumatikus fűrógép / Masina de gaurit pneumatica / Pneumatická vrtačka / Pneumatická vřtačka / Pnevmatiski vrtalnik / Pneumatinis gręžtuvas / Pneumatiska urbjmašina / Pneumatiline trell / Пневматична пробивна машина / Pneumatiska bušilica / Pneumatiska bušilica / Δράπανο αέρος / Taladradora neumática / Trapano pneumatico / Berbequim pneumático / Erçeuse pneumatique / Pneumatische boormachine

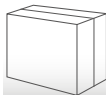
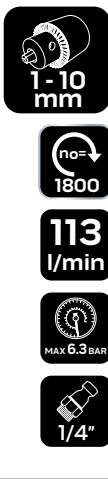

Ref.	☒	EAN
14-514	1/10	5907558444865



Ref.	☒	EAN
14-025	0/20	5906692026920

Młotek udarowy pneumatyczny

Pneumatic impact hammer / Schlaghammer pneumatisch / Молоток ударный пневматический / Перфоратор пневматичний / Pneumatikus vésőkalapács / Ciocan cu percucie pneumatică / Pneumatické rázové kladívko / Pneumatické príklepové kladívko / Pnevmatisko udarno kladivo / Pneumatinis atskėlimo plaktukas / Pneumatiskais sitamais āmurs / Pneumatiline lookvasar / Пневматичен ударен чук / Pneumatski udarni čekić / Udarni pneumatski čekić / Κρουστική σφύρα αέρος / Martillo neumático de impacto / Martello pneumatico / Martelo de impacto pneumático / Martelet à chocs pneumatique / Pneumatische slaghammer



Ref.	☒	EAN
14-027	1/10	5906692026913

Piła pneumatyczna

Air Body Saw / Luftkörper säge / Воздушная пила / Пневматична пила для мила / Pneumatikus fűrész a testhez / Ferăstrău pneumatic pentru caroserie / Pneumatická píla / Pneumatická píla / Pneumatska žaga / Pneumatinis pjūklas / Pneumatiskais zāģis / Pneumatiline saag / Pneumatska píla / Пневматска тестера / Αεροπίλοιο / Sierra neumática / Sega pneumática / Serra pneumática / Scie pneumatique / Pneumatische saag



Ref.	☒	EAN
14-035	0/20	5906692026982

Pneumatyczny młotek igłowy czółowy

Pneumatic butt-face needle hammer / Pneumatisher Front-Nadelhammer / Пневматический изольчатый зачистной молоток / Голковий пневматичний торцевий молоток / Pneumatikus homlok tűkalapács / Ciocan cu ace pneumatic frontal / Čelní pneumatiké jehlové kladivo / Čelové pneumatiké ihlicové kladivo / Pnevmatisko konicasto kladivo / Pneumatinis adatinis plaktukas / Pneumatiskais priekšējais adatu āmurs / Pneumatiline ots-põelhaamer / Пневматичен челен иглен чук / Pneumatski iglasti čeoní čekić / Čeoní pneumatski iglasti čekić / Μηροσπίο pneυματικό σφύρα βελόνας / Martillo neumático de aguja frontal / Martello pneumatico ad aghi / Martelo de agulha frontal pneumático / Marteau pneumatique à aiguilles frontal / Pneumatische naaldbikhamer



Ref.	☒	EAN
14-031	0/10	5907558468977



Ref.	☒	EAN
14-032	1/6	5907558468984

Zszywacz pneumatyczny

Pneumatic stapler / Pneumatische Heftmaschine / Степлер пневматический / Степлер пневматичний / Pneumatikus tűzőgép / Capsator pneumatic / Pneumatická sešivačka / Pneumatická zošivačka / Pnevmatiski sprenjač / Pneumatinis kablų pistoletas / Pnevmatiskais skavotājs / Pneumatiline klambripūstol / Пневматичен телбод / Pneumatska klamerica / Pneumatska heftalica / Συρραπτική αέρος / Grapadora neumática / Graffettatrice pneumatica / Máquina de pontear pneumática / Agrafeuse pneumatique / Pneumatische hechtmaschine

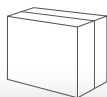
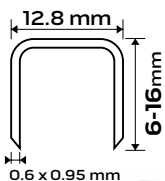

Ref.	☒	EAN
14-572	0/10	5907558444889

Dłuta komplet

Chisel set / Beitelsetz / Набор долот / Зубила ма пробивачи / Vésőkészlet / Set dălți / Sada dlát / Súprava dlát / Garnitura dlet / Kaltų komplektas / Kaltų komplekts / Peilīte komplekt / Секачи и шило / Spica / Sekac / Συλλογή από σμίλες / Juego de formones / Set di scalpelli / Conjunto de Raspadores / Jeu de ciseaux



Ref.	☒	EAN
14-029	4/24	5907558455298

Ostrza 24T i 32T

24T and 32T blades / 24Z und 32Z Klingen / Отвалы 24T и 32T / Леза 24T i 32T / 24T és 32T pengék / Lame de 24T și 32T / Čepele 24T a 32T / Čepele 24T a 32T / 24T in 32T rezila / 24T ir 32T peiliukai / 24T un 32T asmeņi / 24T ja 32T labad / 24T u 32T ostrueta / 24T i 32T oštrice / Душприце од 24T u 32T / Λεπίδες 24T και 32T / 24T ja 32T labad / Lame 24T e 32T / Láminas 24T e 32T / Lames 24T et 32T / 24T en 32T messen



Ref.	☒	EAN
14-034-401	20/200	5907558495898

Sprężyny

Springs / Federn / Пружини / Пружини / Rugó készlet / Arcuri / Pružiny / Pružiny / Vzmeti / Spyruoklių rinkinys / Atsperes / Vedrud / Пружини / Opruge / Opruge / Στε ελατήρια / Espirales / Molle / Molas / Ressorts / Veren

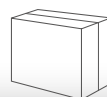
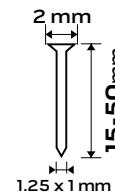
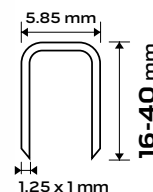

Ref.	☒	EAN
14-570	0/10	5907558444872

Sprężyny

Springs / Federn / Пружини / Пружини / Rugó készlet / Arcuri / Pružiny / Pružiny / Vzmeti / Spyruoklių rinkinys / Atsperes / Vedrud / Пружини / Opruge / Opruge / Στε ελατήρια / Espirales / Molle / Molas / Ressorts / Veren



Ref.	☒	EAN
14-030	4/40	5907558455304

Tarcza tnąca

Cutting disc / Trennscheibe / Отрезной диск / Відірзний диск / Vágókorong / Disc de tăiere / Řezací kotouč / Rezacni disk / Pjovimo disks / Grietasas disks / Lāikeketas / Режущий диск / Disk za rezanje / Диск за сечење / Δίσκος κοπής / Disco cortante / Disco da taglio / Disco de corte / Scie circulaire / Doorslijpschijf



Ref.	☒	EAN
14-017-400	20/200	5907558495881

Zszywki

Staples / Klammern / Скобы / Скобы / Τύζκαρος / Capsator / Sešivací spony / Sponky / Sponke / Kabès / Skavas / Klambid / Телчема / Municija za klamericu / Heftalica / Συρραπήρες / Grapas / Punti metallici / Pontas / Agrafes / Hechters

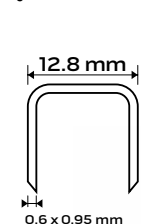

x4000 GALVANIZED STEEL TYPE 80 **GA21** FOR STAPLER 14-572

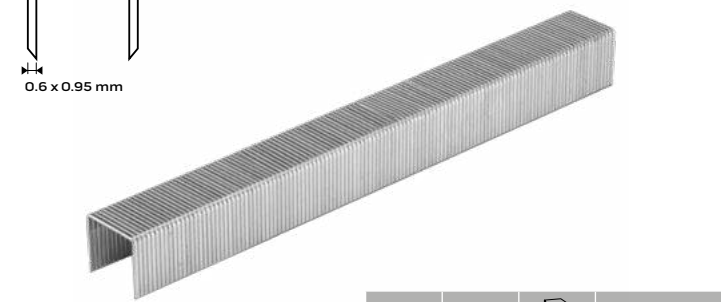

Ref.	L[mm]	☒	EAN
14-610	6	0/30	5907558453720
14-611	8	0/30	5907558453737
14-612	10	0/30	5907558453744
14-613	12	0/30	5907558453751
14-614	14	0/30	5907558453768
14-615	16	0/30	5907558453775

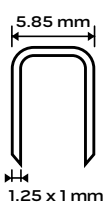
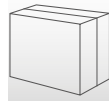

x4000 GALVANIZED STEEL TYPE 90 **GA18** FOR STAPLER 14-570

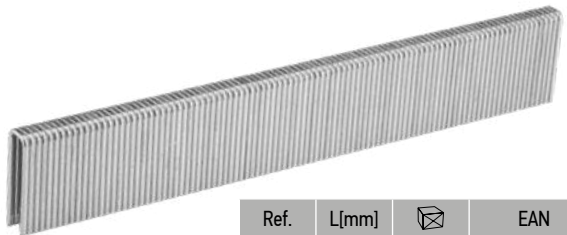

Ref.	L[mm]	☒	EAN
14-620	10	0/16	5907558453782
14-621	12	0/16	5907558453799
14-622	15	0/16	5907558453805
14-623	20	0/12	5907558453812
14-624	22	0/12	5907558453829
14-625	25	0/12	5907558453836
14-626	28	0/12	5907558453843
14-627	30	0/12	5907558453850
14-628	32	0/8	5907558453867
14-629	35	0/8	5907558453874
14-630	38	0/6	5907558453881
14-631	40	0/6	5907558453898



Gwoździe

Nails / Nägel / Γαζάκι / Цвяжы / Tűzőszeg / Cuie / Hřebíky / Klinec / Žebliki / Vinyis / Naglas / Naelad / Пирони за манер / Čavlići za pneumatsku klamericu / Municija za heftalica / Καρφιά / Clavos / Chiodi / Pontas / Agrafes / Spijkers

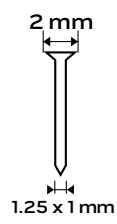

x4000 GALVANIZED STEEL TYPE 300 **GA18** FOR STAPLER 14-570

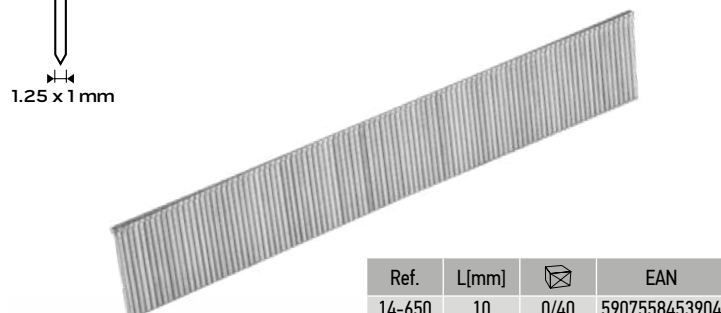

Ref.	L[mm]	☒	EAN
14-650	10	0/40	5907558453904
14-651	15	0/20	5907558453911
14-652	20	0/20	5907558453928
14-653	25	0/20	5907558453935
14-654	30	0/20	5907558453942
14-655	35	0/12	5907558453959
14-656	40	0/12	5907558453966
14-657	45	0/12	5907558453973
14-658	50	0/12	5907558453980

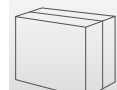

Zestaw nasadek

Socket set / Aufsatzset / Набор головок торцевых / Набор насадок торцевых / Dugókulcs készlet alufélnihez, vékonyfalú / Set duze / Sada nasadek / Súprava nástr. ključov / Garnitura nasadnih ključev / Antgaliu rinkinys / Muciju komplekts / Padrunikomplekt / Геодор компл / Šesterokutne kapice / Gedora set / Συλλογή καρδικαίων / Llaves de vaso / Set di boccole / Kit de bicos / Jeu de douilles / Set van doppen



CrMo steel
Alu
1/2"

Ref.	☒	EAN
12-350	0/20	5907558435849

Nasadka udarowa

Impact socket / Schlagaufsatz / Насадка ударная / Патрон перфораторный / Gépi dugókulcs / Врѣтарѣ cu percutiѣ / Prikleponý nástavec / Prikleponý nástavec / Udarni nasadni ključ / Antgaliu kalimui / Triecienuzgalis / Löökötsak / Ударна наставка / Udarni nasadni nastavak / Udarana karica / Υποδοχή κρουστικού ανταλλακτικού / Llave de vaso para atornilladores de impacto / Bussola esagonale / Bocal de impacto / Douille à choc / Slagdop

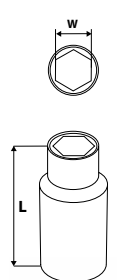

25 years GUARANTEE **CrMo steel** **1/2"**

Ref.	W[mm]	L[mm]	☒	EAN
12-210	10	38	20/200	5907558423808
12-212	12	38	20/200	5907558423822
12-213	13	38	20/200	5907558423839
12-214	14	38	20/200	5907558423846
12-215	15	38	20/200	5907558423853
12-216	16	38	20/200	5907558423860
12-217	17	38	20/200	5907558423877
12-219	19	38	20/200	5907558423884
12-221	21	38	20/200	5907558423891
12-222	22	38	20/200	5907558423907
12-224	24	38	20/200	5907558423914

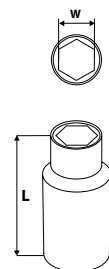
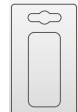

25 years GUARANTEE **CrMo steel** **1/2"**

Ref.	W[mm]	L[mm]	☒	EAN
12-310	10	78	10/100	5907558423921
12-312	12	78	10/100	5907558423945
12-313	13	78	10/100	5907558423952
12-314	14	78	10/100	5907558423969
12-315	15	78	10/100	5907558423976
12-316	16	78	10/100	5907558423983
12-317	17	78	10/100	5907558423990
12-319	19	78	10/50	5907558424003
12-321	21	78	10/50	5907558424010
12-322	22	78	10/50	5907558424027
12-324	24	78	10/50	5907558424034



Nasadka udarowa

Impact socket / Schlagaußsatz / Насадка ударная / Патрон перфораторный / Gépi dugókulcs / Brătără cu percúție / Příklepový nástavec / Příklepový nástavec / Udarni nasadni ključ / Antgalis kalimui / Triecienuzgalis / Löökotsak / Ударна наставка / Udarni nasadni nastavak / Udarna karica / Υποβοήθη κρουστικού ανταλλακτικού / Llave de vaso para atornilladores de impacto / Bussola esagonale / Bocal de impacto / Douille à choc / Slagtop

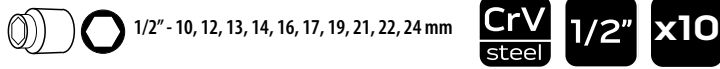

Ref.	☒	EAN
12-101	0/20	5907558414509

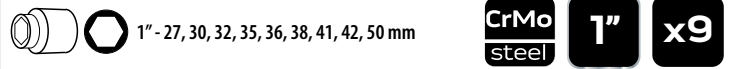

Ref.	☒	EAN
12-105	0/2	5907558414530

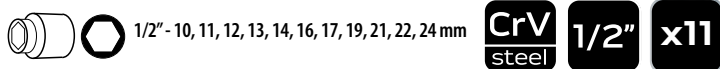

Ref.	☒	EAN
12-102	0/10	5907558414516

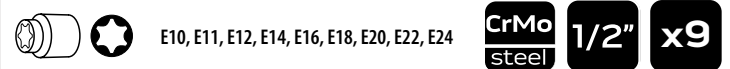

Ref.	☒	EAN
12-110	0/20	5907558414554

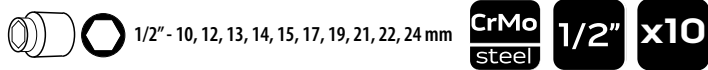

Ref.	☒	EAN
12-107	0/10	5907558414547

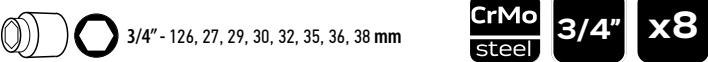

Ref.	☒	EAN
12-115	0/6	5907558414523



Ref.	☒	☒	EAN
10-258	T30	1/10	5907558469660
10-259	T40	1/10	5907558469677
10-260	T45	1/10	5907558469684
10-261	T50	1/10	5907558469691
10-262	T55	1/10	5907558469707
10-263	T60	1/10	5907558469714
10-264	T70	1/10	5907558469721
10-265	T80	1/10	5907558469738



Przedłużka udarowa

Impact extension / Wirkungsverlängerung / Ударный удлинитель / Ударний Подовжувач / Toldászár / Prelungitor / Prodlužovák / Predĺženie / Podaljšek / Ilgiktis / Pagarinātājs / Pikenus / Удължител / Produženi poluga / Produzena poluga / Προέκταση / Alargadera / Prolunga / Extensão / Prolongation / Verlengstuk



Ref.	L[mm]	☒	EAN
10-250	50	1/10	5907558469585
10-251	75	1/20	5907558469592
10-252	125	1/10	5907558469608

Klucze udarowe torx

Impact Torx bit socket set / Torx-Schlagschrauber-Satz / "Набор ударных торцовых ключей Torx" / Набор ключів ударних «Торх» / Torx gépi kulcsok / Chei cu impact torx / Nástrčné kľúče torx / Rázové kľúče torx / Udarni nasadni ključići Torx / Smūginiai raktai „TORX“ / Triecienatslēgas torx / Torx-ļoķnūvētmed / Ударни ключове torx / udarni ključevići torx / Udarni ključevići torx / Σετ κρουστικά μπουλονόκλειδα Torx / Llaves de impacto torx / Inserti Torx / Jogo de chaves de percussão torx / Clés à choc torx / Torx slagsleutels

★ T25, T27, T30, T40, T45, T50, T55, T60

CrMo steel 1/2" x8



★ T30, T40, T45, T50, T55, T60, T70, T80

CrMo steel 1/2"

x8



Ref.	☒	EAN
08-712	0/20	5907558418620



Ref.	☒	EAN
10-257	1/10	5907558469653

Przegub udarowy

Impact joint / Schlaggelenk / Ударный шарнир / Ударний шарнір / Csukló / Articulație de impact / Nárazový kloub / Nárazový čap / Udarnia zglob / Lankstas / Šarnīrs / Klamber / Шарнир / Zglob / Zglob / Μεντεσές / Articulación / Snodo / Articulação / Articulation / Spilverbinding

CrMo steel



Ref.	Info	☒	EAN
10-253	1/4"	1/20	5907558469615
10-254	3/8"	1/20	5907558469622
10-255	1/2"	1/10	5907558469639

1/4"

3/8"

1/2"

x3

CrMo steel



Ref.	☒	EAN
10-256	1/10	5907558469646

Filtr odwadniacz

Draining filter / Entwässerungsfilter / Фильтр / Фильтр сепараторный / Víztelenítő szűrő, fémházas / Filtru - dezodorizant / Odvodňovací filtr / Odvodňovací filter / Odvodni filter / Filtras - džiovinuvas / Atūdepošanas filtrs / Veefilter / Фильтр за отводняване / Filtrar za upijanje vode / Odvodni filter / Φίλτρο-διαχωριστής / Filtro de drenaje / Filtro di drenaggio / Filtra / Filtre purgeur / Filter drainage

1/2"

0-9 bar

CE

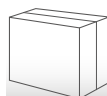

Ref.	☒	EAN
14-732	1/50	5907558452228



1/2"

0-9 bar

CE

Ref.	☒	EAN
14-730	1/25	5907558452211



1/4"

Ref.	☒	EAN
14-550	1/125	5907558444896

Zestaw do uzdatniania powietrza

Air treatment kit / Luftaufbereitungsset / Набор для очистки воздуха / Комплект до підготовки повітря / Levegőelőkészítő egység / Garnitură de inobilare aerului / Sada pro úpravu vzduchu / Súprava na upravovanie vzduchu / Komplet za obdelavo zraka / Suslegto oro odorojimo jrenginy / Gaisa atitīšanas komplekts / Ūhupuhastuskomplekt / Комплект за подготовка на въздуха / Set za pripremu zraka / Pribor za tretiranje vazduh / Σετ καθαρισμού αέρα / Dispositivo de procesamiento del aire / Filtro, riduttore, lubrificatore / Kit para purificar ar / Jeu pour traitement d'air / Set van mondstukken voor zandblazen



Ref.	⊠	EAN
14-734	1/25	5907558452235



Ref.	⊠	EAN
14-735	1/25	5906692027019

Zwijadło pneumatyczne

Pneumatic reel / Pneumatische Rolle / Пневматическая катушка / Пневматична катушка / Pneumatikus orsó / Bobina pneumatica / Pneumatiský naviják / Pneumatiský navijak / Pneumatski kolut / Pneumatisk kolut / Pnevmatiskā spēle / Pnevmaatiline rull / Пневматична макара / Pneumatski kolut / Пневматски колут / Πνευματικό καρούλι / Carrete neumática / Bobina pneumatica / Carretilha pneumática / Enrouleur pneumatique / Pneumatische haspel



15m	9.5mm	1/4"	20 BAR	hybrid material PVC + RUBBER
-----	-------	------	--------	------------------------------

Ref.	⊠	EAN
10-700	1/1	5907558497359



15m	9.5mm	METAL BODY	20 BAR	hybrid material PVC + RUBBER	HEAVY DUTY	1/4"
-----	-------	------------	--------	------------------------------	------------	------

Ref.	⊠	EAN
10-701	1/1	5907558497366

Przewód ciśnieniowy spiralny

High pressure spiral hose / Spiraldruckleitung / Шланг сжатого воздуха спиральный / Шланг високого тиску, армований / Pneumatikus spiráltömlő / Furtun spiral presiune înaltă / Tlakové potrubí spirálové / Vysokotlaká špirálová hadica / Visokotlačna spiralna gibka cev / Spiralinē aukšto slēgio žarna / Spirālveida gaisa cauruļvads / Kõrgsurvevoolik (spiraal) / Маркуч за компресор / Spirarno crijevo najlonsko / Crevo za visoki pritisak / Σπυροειδής ρύγχος υψηλής πίεσης / Tubo de presión / Tubo a spirale in nylon / Cabo de tensão espiral / Durite de pression hélicoïdale / Spiraal drukleiding

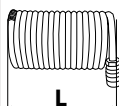

Pu	16 BAR max	+35°C	-10°C
----	------------	-------	-------



Ref.	L [m]	⊘ [mm]	⊙ [mm]	⊠	EAN
12-070-1	5	6,5	10,0	1/20	5907558474787
12-071-1	10	6,5	10,0	1/10	5907558474794
12-072-1	15	6,5	10,0	1/6	5907558474800
12-074-1	5	8,0	12,0	1/20	5907558474817
12-075-1	10	8,0	12,0	1/10	5907558474824
12-076-1	15	8,0	12,0	1/6	5907558474831

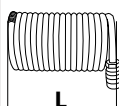

15 m	Pu	16 BAR max
------	----	------------



Ref.	L [m]	⊘ [mm]	⊙ [mm]	⊠	EAN
14-800-1	15	10,0	15,0	1/6	5907558474848
14-802-1	15	12,0	17,0	1/6	5907558474855

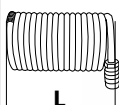

PE	8mm	5mm	16 BAR max
----	-----	-----	------------



Ref.	L [m]	⊘ [mm]	⊙ [mm]	⊠	EAN
14-808-1	5	5,0	8,0	1/20	5907558474886
14-804-1	10	5,0	8,0	1/10	5907558474862
14-806-1	15	5,0	8,0	1/6	5907558474879

Przewód ciśnieniowy zbrojony

High pressure reinforced hose / Druckleitung verstärkt / Шланг высокого давления армированный / Шланг високого тиску, армований / Pneumatikus tömlő / Furtun armat presiune înaltă / Tlakové potrubí vyztužené / Vysokotlaká hadica / Visokotlačna gibka cev / Sustiprinta aukšto slēgio žarna / Augstspiediena gaisa cauruļvads / Tugevdatud kõrgsurvevoolik / Маркуч за вис. налягане / crijevo za visoki pritisak / Crevo za visoki pritisak / Ενισχυμένος ρύγχος υψηλής πίεσης / Tubo de presión reforzado / Tubo a pressione rinforzato / Cabo de tensão armado / Durite de pression armée



PVC	+40°C	-10°C
-----	-------	-------

Ref.	L [m]	⊘ [mm]	⊙ [mm]	P _{max} [bar]	⊠	EAN
12-079	50	8,0	13,0	19	0/1	5907558414936
12-080	50	10,0	15,0	17	0/1	5907558414943
12-081	50	12,0	17,0	13	0/1	5907558414950

Szybkozłączka

Quick coupler / Schnellkupplungen / Быстросменная муфта / Муфта швидкорознімна / Pneumatikus gyorscsatlakozó / Conector rapid / Rychlospojka / Rýchlospojka / Hitra spojka / Greitoji jungtis / Ātrsvienotājs / Kiirühendus / Бърза връзка / Spojnica / Brzo odvajanje / Συζευκτήρας ταχείας απελευθέρωσης / Acoplador rápido / Connettore rapido con presa per tubo / União rápida / Rapport rapide / Snelkoppeling



Ref.	⌀ [mm]	⌀ [mm]	⊠	EAN
12-600	4	6	0/36	5907558417685
12-601	6	8	0/27	5907558417692
12-602	8	10	0/27	5907558417708



Ref.	⌀ [mm]	⊠	EAN
12-620	7	0/36	5907558417814
12-621	8	0/36	5907558417821
12-622	10	0/36	5907558417838
12-623	12	0/36	5907558417845



Ref.	⌀ [mm]	⊠	EAN
12-630	7	0/36	5907558417890
12-631	8	0/36	5907558417906
12-632	10	0/36	5907558417913

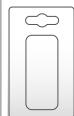

Ref.	⊠ ["]	⊠	EAN
12-635	1/4	0/36	5907558417920
12-636	3/8	0/36	5907558417937
12-637	1/2	0/36	5907558417944



Ref.	⊠ ["]	⊠	EAN
12-645	1/4	0/36	5907558417975
12-646	3/8	0/36	5907558417982



Ref.	⊠ ["]	⊠	EAN
12-650	1/4	0/36	5907558417999
12-651	3/8	0/36	5907558418002

Złącze do węża

Hose connection / Schlauchverbinder / Соединители для шланга / Арматура до шлангу / Pneumatikus tömlőtoldaló / Imbinare de furtun / Spojka pro hadici / Spoj na hadicu / Konektor za cev / Jungtis žarnai / Šļūtenes savienotāji / Voolikuühendus / Съединение за шланга / Spojna za cijev / Spoj za crevo / Συνδεσμοί εύκαμπτου σωλήνα / Junta para manguera / Connettore per tubo / União p. Manguera / Raccord pour flexible / Verbindingsstuk voor slang



Ref.	⌀ [mm]	⊠	EAN
12-610	6	0/36	5907558417739
12-611	8	0/36	5907558417746
12-612	10	0/36	5907558417753
12-613	12	0/36	5907558417760



Ref.	⌀ [mm]	⊠ ["]	⊠	EAN
12-615	6	1/4	0/36	5907558417777
12-616	10	1/4	0/36	5907558417784
12-617	10	1/2	0/36	5907558417791
12-618	12	1/2	0/36	5907558417807

Końcówka do szybkozłączki

Quick coupler tip / Endstück für Schnellkupplung / Наконечник быстрого соединения / Насадка для швидко рознімної муфти / Pneumatikus csatlakozó külsőmenet- gyorsvég / Piesă de conectare rapidă / Koncovka pro rychlospojku / Nástavec rýchlospojka / Nástavec za hitro spojka / Greitaięgis jungties antgalis / Ātrsvienojuma uzgalis / Kiirühendusotsak / Накраїник за бърза връзка / nastavak za spojnicu / Kraj za brzo priključivanje / Κεφαλή ταχείας σύνδεσης / Boquilla para acoplador rápido / Connettore rapido con presa per tubo / Ponteiro do uniões rápidas / Embout pour raccord rapide / Eindstuk voor snelkoppeling

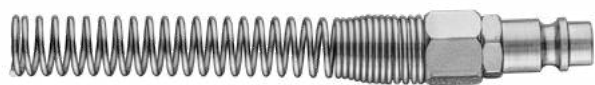

Ref.	⌀ [mm]	⌀ [mm]	⊠	EAN
12-605	6	8	0/27	5907558417715
12-606	8	10	0/36	5907558417722



Ref.	⌀ [mm]	⊠	EAN
12-625	7	0/36	5907558417852
12-626	8	0/36	5907558417869
12-627	10	0/36	5907558417876
12-628	12	0/36	5907558417883



Ref.	⊠ ["]	⊠	EAN
12-640	1/4	0/30	5907558417951
12-641	3/8	0/36	5907558417968

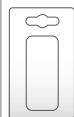

Ref.	⊠ ["]	⊠	EAN
12-655	1/4	0/36	5907558418019
12-656	3/8	0/36	5907558418026

Kompressor

Compressor / Kompessor / Компрессор / Компресор / Kompresszor / Compresor / Kompresor / Kompresor / Kompresor / Kompresorius / Kompresors / Kompresor / Компресор / Kompresor / Kompresor / Συμπιεστής / Compressor / Compresore / Compresor / Compresseur / Compresor



- 40 l
- 1500W
- 230V ~ 50Hz
- 169 L/min
- $n_0=2850$
- OFF 8BAR
- Ta +40°C

Ref.	☒	EAN
12K010-1	0/1	5907558479607



- 24L
- 900W
- 230V ~ 50Hz
- MAX 8 BAR
- 135 L/min

Ref.	☒	EAN
12K023	0/1	5907558477313



- 50L
- 1050W
- 230V ~ 50Hz
- MAX 8 BAR
- 169 L/min

Ref.	☒	EAN
12K024	0/1	5907558477320



- 100L
- 1500W
- 230V ~ 50Hz
- MAX 10BAR
- 280 L/min

Ref.	☒	EAN
12K030-1	0/1	5907558479645



- 150L
- 2200W
- 230V ~ 50Hz
- 330 L/min
- MAX 10 BAR

Ref.	☒	EAN
12K031-1	0/1	5907558479652



- 12L
- 550W
- 230V ~ 50Hz
- MAX 8 BAR
- 95 L/min
- 79dB QUIET OPERATION

Ref.	☒	EAN
12K020-1	0/1	5907558479614

Kompresor

Compressor / Kompessor / Компрессор / Компресор / Kompressoer / Compresor / Kompresor / Kompresor / Kompresor / Kompresorius / Kompresors / Kompessor / Компресор / Kompresor / Kompresor / Συμπιεστής / Compressor / Compresore / Compessor / Compresseur / Compresor



24 l

750W

230V ~
50Hz

25 l/min

MAX 8 BAR

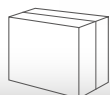

Ref.	☒	EAN
12K021-1	0/1	5907558479621



50 l

1100W

230V ~
50Hz

180 l/min

MAX 8 BAR

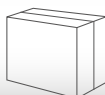

Ref.	☒	EAN
12K022-1	0/1	5907558479638

Pistolet do pompowania

Inflating gun / Pumpenpistole / Пистолет для подкачки шин / Пистолет до помпування / Kerékfúvató pisztoly nyomásmérővel / Pistol de pompare /umflare / Plnicí pistole / Pumpovací pištol' / Pištola za črpanje / Siurbimo pistoletas / Sūkņšanas pistole / Pūstolpump / Пистолет за изпомпване / Pištolj za pumpanje / Pištolj za pumpanje / Πιστόλι φουσκώματος ελαστικών / Pistola para inflar / Gonfiatore per pneumatici / Pistola p. Bomba / Pistolet de pompage / Pomppistol



WORKING PRESSURE
0-4BAR

max 12 BAR

5m

Ref.	☒	EAN
14-719	0/1	5906692026838



max 12 BAR

WORKING PRESSURE
0-4BAR

Ref.	☒	EAN
14-714-1	1/10	5906692026845



ALU BODY

300mm

max 12 BAR

CE

Ref.	☒	EAN
14-716	1/20	5907558452167



max 12 BAR

WORKING PRESSURE
0-4BAR

Ref.	☒	EAN
14-715	1/20	5907558452167

Pistolet do pompowania

Inflating gun / Pumpenpistole / Πιστολετ для подкачки шин / Пистолеτ до помпування / Kerékfúvató pisztoly nyomásmérővel / Pistol de pompare /umflare / Plinici pistole / Pmpovacia pištoľ / Pištoľa za črpanje / Siurbimo pistoletas / Sūkņēšanas pistole / Pūstoļpump / Пустолеτ за изпомване / Pištoľ za pumpanje / Pištoľ za pumpanje / Πιστολι φουσκώματος ελαστικών / Pistola para inflar / Gonfiatore per pneumatici / Pistola p. Bomba / Pistolet de pompage / Pomppistol



Ref.	⊠	EAN
14-718	0/20	5907558452174

Wężyk do pompowania

Hose for inflating gun / Schlauch zum Pumpen / Шланг к пистолету / Шланг до пистолеτу / Kerékfúvató tömlő / Furtun pentru pistol de pompare / Hadička na pmpování / Hadička na pmpovanie / Cev za črpanje / Žarnelē pumpavimui / Saurulīte sūkņēšanai / Pumbavoolik / Маркуч за напомяване / Crjevo za pumpanje / Crevo za pumpanje / Εύκαμπτος σωλήνας πιστολιού / Manguera para bombear / Tubo di gonfiaggio / Mangueira p. bombar / Flexible de pompage / Pompslang



Ref.	L [mm]	⊠	EAN
14-820	400	0/100	5907558452280

Pistolet natryskowy

Spray gun / Sprühpistole / Пустолеτ-распылитель / Фарбонпульт / Festékszóró pisztoly / Pistol de duș / Stříkací pistole / Striekacia pištoľ / Brizgalna pištoľ / Purškimo pistoletas / Pistole-smidzinātājs / Pihustuspüstol / Пустолеτ - нулеерузатор / Pištoľ za prskanje / Pištoľ za prskanje / Πιστολι ψεκασμού / Pistola de aspersiō / Pistola a spruzzo / Pistola de borrfjar / Pistolet à projection / Spuitpistol



Ref.	⊠	EAN
14-700	1/20	5907558452075



Ref.	⊠	EAN
14-702	1/12	5907558452082



Ref.	⊠	EAN
14-703	1/20	5907558452099



Ref.	⊠	EAN
14-704	1/8	5907558452105

Pistolet natryskowy

Spray gun / Sprühpistole / Пистолет-распылитель / Фарбопульт / Festékszóró pisztoly / Pistol de duș / Stríkáci pistole / Striekacia pištol / Brizgalna pištol / Purškimo pistoletas / Pistole-smidzinātājs / Pihustuspüstol / Пистолет - пульверизатор / Pištolj za prskanje / Pištolj za prskanje / Πιστόλι ψεκασμού / Pistola de aspersión / Pistola a spruzza / Pistola de borrifar / Pistolet à projection / Spruitpistool



4,7l

1/4"

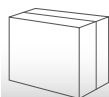

Ref.	☒	EAN
14-220	0/10	5907558441901

Pistolet do konserwacji

Maintenance gun / Wartungspistole / Антикоррозионный пистолет со шлангом / Фарбопульт / Alvázvédő szórópisztoly tömlővel / Pistol de conservare / Pistole pro údržbu / Konzervačná pištol / Pištol za nanašanje zaščite / Oro išsiurbimo pistoletas / Konservācijas pistole / Hoolduspüstol / Пистолет за консервация / Pištolj za održavanje / Pištolj za konzerviranje / Πιστόλι ψεκασμού για συντήρηση / Pistola de conservación / Pistola per rivestimenti / Pistola p. Conservação / Pistolet d'entretien / Onderhoudspistool



ALU BODY

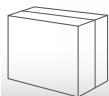

Ref.	☒	EAN
14-720	1/20	5907558452181

Pistolet do piaskowania

Sandblasting gun / Pistole zum Sandstrahlen / Пескоструйный пистолет с бачком / Пистолет до піскоструменевої обробки / Homokfúvó pisztoly tartállyal / Pistol de sablare / Piskovací pistole / Pieskovacia pištol / Pištol za peskanje / Smėliavimo pistoletas / Smiļštrūkløšanas pistole / Liivapirts / Пистолет за пескARENJE / Pištolj za peskarenje / Πιστόλι αμμοβολής / Pistolas de decapado por arena / Pistola per sabbatura / Pistola p. Areia / Pistolet à sablage / Zandblaaspistool



ALU BODY

1L

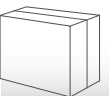

Ref.	☒	EAN
14-724	1/10	5907558452204

Zestaw lakierniczy

Lacquer set / Lackierset / Набор для лакирования / Комплект до лакофарбувальних робіт / Kompressor tartozékészlet / Garnitură de lăcuit / Lakovací sada / Súprava na lakovanie / Komplet za lakiranje / Komplektas dažytojui / Laku komplekts / Lakkimiskomplekt / Комплект за лакиране / Set za lakiranje / Pribor za lakiranje / Σετ βερνικώματος / Juego de herramientas para barnizado / Pistola a spruzza in kit / Kit p. Verniz / Jeu d'outils de peinture / Lakset



x5

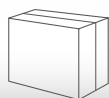

Ref.	☒	EAN
14-699	1/10	5907558452068

Pistolet do mycia

Washing gun / Reinigungspistole / Пистолет-распылитель для мытья / Пистолет для митня / Alvázvédő szórópisztoly / Pistol de spălat / Pistole na mytí / Čistiaca pištol / Pištol za pranje / Plovimo pistoletas / Mazgāšanas pistole / Pesemispüstol / Пистолет за миене / Pištolj za pranje / Pištolj za pranje / Πιστόλι πλύσης / Pistola de limpiar / Pistola per pulizia / Pistola p. Limpeza / Pistolet de lavage / Waspistool



215 mm

1L

2.5-4 BAR



Ref.	☒	EAN
14-706	1/20	5907558452112

Pistolet do przedmuchiwania

Blowing gun / Pistole zum Durchblasen / Пистолет для продувания / Пистолет до продування / Pneumatikus lefúvatápisztoly / Pistol de baleiaj / Pistole pro profukování / Prefukovacia pištoľ / Izpihovalna pištola / Prapūtimo pistoletas / Saupūšanas pistole / Lābilputuspūstol / Пистолет за продување / Pištoľ za ispuhivanje / Πιστόλι αέρος / Pistola de limpieza a chorro de aire / Pistola aria compressa / Pistola para soprar / Pistolet de soufflage / Afblaaspistool



Naolejacz

Oiler / Ölgerät / Смазыватель / Оливорозпилювач / Olajozó pneumatikus / Gresor de ulei / Mazací jednotka / Olejovač / Lubrikator / Τεταλινέ / Ieeļotājs / Ölitusseade / Смазвач / Nauljivač / Podmazivač / Ψεκαστήρας λαδιού / Lubrificador / Oliatore per utensili pneumatici / Máquina oleadora / Huileur / Smeertoestel



Smarownica pneumatyczna

Inflating gun / Pumpenpistole / Пистолет для подкачки шин / Пистолет до помпування / Kerékfúvató pisztoly nyomásmérővel / Pistol de pompare / umflare / Plnicí pistole / Pumpovacia pištoľ / Pištola za črpanje / Siurbimo pistoletas / Sūkņēšanas pistole / Pūstolpump / Пистолет за изпомпване / Pištoľ za pumpanje / Πιστόλι φουσκώματος ελαστικών / Pistola para inflar / Gonfiatore per pneumatici / Pistola p. Bomba / Pistolet de pompaje / Pomppistool



AKCESORIA I GADŻETY MOTORYZACYJNE

automotive
accessories and gadgets

автомобільні аксесуари
та гаджети



Wielowarstwowy pokrowiec na samchód

A multi-layer car cover / Mehrschichtige Autoabdeckung / Багатошаровий автомобільний чохол / Многослойный автомобильный чехол / Többrétegű autónédő / Huså auto multistrat / Vievrstvý potah na auto / Viacvrstvový potah na auto / Večplastna prevleka za avto / Kelių sluoksnių / Automobila pārsegs vairākos slāņos / Покрывало за кола в няколко слоя / Κάλυμμα αυτοκινήτου πολλαπλών στρώσεων / Copertura per auto multistrato / Funda de coche multicapa / Housse de voiture en plusieurs couches / Cobertura de automóvel em várias camadas / Autohoes in meerdere lagen /



Ref.	📦	EAN
10-474	0/1	5907558471113

Ref.	📦	EAN
10-475	0/5	5907558473940

Wielorazowy pokrowiec na siedzenie

Reusable seat cover / Багатошаровий чохол для сидіння / Huså reutilizabilă pentru scaun / Újrafelhasználható ülészuzat / Copriedile riutilizzabile / Housse de siège réutilisable / Wiederverwendbarer Sitzbezug / Многошаровий чехол для сиденья / Oprakovaně použitelný potah sedadla / Oprakovane použiteľný potah sedadla / Navlaka za sjedalo za višekratnu upotrebu / Daugkartinio naudojimo sėdynės užvalkalas / Atkārtoti lietojams sēdekļa pārvalks / Prevleka za sedež za večkratno uporabo / Покрывало за седалка за многократна употреба / Прекирвач за седиште за виšekratnu upotrebu / Επαναχρησιμοποιήσιμο κάλυμμα καθίσματος / Herbruikbare stoelhoe / Cobertura reutilizável do assento / Funda de asiento reutilizable / Korduvkasutatav istmekate



Ref.	📦	EAN
11-473	1/50	5906692024186

Pokrowiec do bagażnika

Boot cover / Чохол для багажника / Sacac de portbagaj / Cszimafedél / Coperchio dello stivale / Cache-bottes / Kofferraumdeckel / Крышка багажника / Kryt bot / Kryt topánky / Poklopac prtljažnika / Batų dangtis / Zābaku pārsegs / Pokrov prtljažnika / Капак на багажника / Поклопац пртљажника / Κάλυμμα μπότας / Laarsafdekking / Cobertura da bota / Cubrebotas / Saara kate



Ref.	📦	EAN
11-474	1/5	5906692024193

Organizer samochodowy

Car organiser / Auto-Organisator / Автомобильный организатор / Автомобильный организёр / Autó szervező / Organizator auto / Organizátor automobilů / Organizátor automobilov / Organizator avtomobilov / Automobilių organizatorius / Auto organizators / Auto korraldaja / Οργανισματορ на автомобилу / Organizator za auto / Οργανισματορ аутомобила / Οργανισματορς αυτοκινήτων / Organizador de coches / Organizatore di auto / Organizador de automóveis / Organisateur de voitures / Auto organisator



Ref.	📦	EAN
11-472	1/10	5906692024179



Ref.	📦	EAN
10-650		5907558477245



Ref.	📦	EAN
10-651		5907558477252

Organizer samochodowy

Car organiser / Auto-Organisator / Автомобильный организатор / Автомобильный органайзер / Autó szervező / Organizator auto / Organizátor automobilů / Organizátor automobilov / Organizator avtomobilov / Automobiliu organizatorius / Auto organizators / Auto korrallaja / Организатор на автомобили / Organizator za auto / Организатор автомобиля / Οργανωτής αυτοκινήτων / Organizador de coches / Organizzatore di auto / Organizador de automóveis / Organisateur de voitures / Auto organisator



POLYESTER

60x
32x
30cm

Ref.	📦	EAN
11-470	1/10	5906692024155

Siatka zabezpieczająca do bagażnika

Safety net for the trunk / Sicherheitsnetz für den Kofferraum / Защитная сетка для багажника / Зашисна сітка для багажника / Biztonsági háló a csomagtartóhoz / Plasa de siguranta pentru portbagaj / Bezpečnostní síť do kufru / Ochranná sieť do kufru / Varnostna mreža za prtljajnik / Apsauginis tinklas bagažinei / Bagāžnieka drošības tīkls / Pagasiruumi turvavõrk / Предпазна мрежа за багажника / Zaštitna mreža za prtljajnik / Сигурносна мрежа за пртљажник / Δίκτυ ασφαλείας για το πορτπαγκάζ / Red de seguridad para el maletero / Rete di sicurezza per il bagagliaio / Rede de segurança para o porta-malas / Filet de sécurité pour le coffre / Veiligheidsnet voor de kofferbak



Ref.	📦	EAN
10-860	0/48	5907558474572

Ośłona na szybę

Windshield cover / Windschutzscheibenabdeckung / Віконна кришка / Чехол для лобового стекла / Szélvédőhuzat / Acoperire parbriz / Obal na čelní sklo / Obal na čelné sklo / Zaščita vetrobranskega stekla / Priekinio stiklo apsauga / Vējstikla aizsargs / Протектор за предно стъкло / Προστατευτικό παμπρίζ / Copri parabrezza / Funda de parabraxis / Protection de pare-brise / Protector de para-brisas / Voorruitbeschermer



1380
x700
mm

ALUMINIUM

single
insulating
layer

Ref.	Info	📦	EAN
10-470	single insulating layer	1/30	5907558471076
10-471	double insulating layer	1/30	5907558471083



POLYESTER

50x
38cm

x2

Ref.	📦	EAN
11-475	0/100	5906692024216



POLYESTER

90x
41cm

tablet
20x28cm
13,5"

Ref.	📦	EAN
11-471	1/20	5906692024162

Urządzenie rozruchowe "Jumpstarter"

Boot device "Jumpstarter" / Starterät "Jumpstarter" / Зарядное устройство "Jumpstarter" / Завантажувальний пристрій "Jumpstarter" / Boot eszköz "Jumpstarter" / Dispozitiv de pornire „Jumpstarter” / Spouštěcí zařízení „Jumpstarter” / Zavádzacie zariadenie „Jumpstarter” / Zagonska naprava "Jumpstarter" / Įkrovos įrenginys „Jumpstarter” / Sākņēšanas ierīce "Jumpstarter" / Buutimisseeade "Jumpstarter" / Стартово устройство "Jumpstarter" / Uredaj za pokretanje "Jumpstarter" / Уреджāj за покретање система "Jumpstarter" / Συσκευή εκκίνησης "Jumpstarter" / Dispositivo de arranque "Jumpstarter" / Dispositivo di avvio "Jumpstarter" / Dispositivo de inicialização "Jumpstarter" / Périphérique de démarrage "Jumpstarter" / Opstartapparaat "Jumpstarter"



14 000
mAh

44.8
W

LiFePo4
long life
battery

MAX
400A
(engine start)

MAX 3.5 BAR

USB
1A / 2A
power bank

LED
light

Ref.	📦	EAN
11-997	1/4	5907558452419

Schodek do samochodu 3w1

3-in-1 car stepping tool / Autoeinstiegsstufe 3in1 / Лестница для автомобиля 3 в 1 / Сходи для автомобіля 3-в-1 / Fellépő gépkocsíhoz 3az1-ben / Treaptă pentru mașină 3 în 1 / Schoděk k autu 3v1 / Schodík do auta / Stopnica za vozilo 3v1 / Automobiliu laiptelis 3 viename / Πακάρπιενι tris vienā automašīnai / Autoaste 3in1 / Багажник 3в1 / Stupanj za vozilo 3u1 / Stepnica za automobil 3u1 / Σκαλοπάτι αυτοκινήτου 3 σε 1 / Escalón de coche 3 en 1 / Scalino per auto 3in1 / Degrau para carro 3 em 1 / Marche de voiture 3 en 1 / 3-In-1 autotrap / 3-i-1 trinn for bil / Fotsteg till bil 3i1 / Porras autoon 3 in 13v1



FITS
MOST
CARS

3in1

up to
230kg

Ref.	📦	EAN
10-477	1/50	5907558471120

Pas mocujący z grzechotką

Fastening strap with ratchet / Befestigungsgurt mit Ratsche / Крепежный ремень с трещоткой / Кріпильний ремень з храповиком / Rögzítő heveder racsnival / Curea de fixare cu clichet / Upevňovací popruh s ráčnou / Upevňovací popruh so západkou / Pritrdilni trak z zaskočnico / Tvirtinimo dirželis su fiksatoriumi / Stiprinājuma sikсна ar sprūdrata mehānismu / Kinnitusrihm koos rihtmaga / Наушка за закрепване с трещотка / Traka za vezivanje s čegrtaljkom / Traka za vezivanje sa čegrtaljom / Ιμάντας στερέωσης με κατάντα / Correa de sujeción con trinquete / Cinghia di fissaggio con cricchetto / Cinta de fixação com catraca / Sangle de fixation avec cliquet / Bevestigingsriem met ratel



PP
260 kg
25 mm

Ref.	Info	☒	EAN
10-702	25 mm x 3 m	1/40	5906692015610
10-703	25 mm x 4,5 m	1/40	5906692015627
10-704	25 mm x 5 m	1/40	5906692015634



PES
500 kg
25 mm

Ref.	Info	☒	EAN
10-705	25 mm x 3 m	1/40	5906692015641
10-706	25 mm x 4,5 m	1/40	5906692015658
10-707	25 mm x 5 m	1/40	5906692015665



PES
1000 kg
25 mm

Ref.	Info	☒	EAN
10-708	25 mm x 4 m	1/20	5906692015672
10-709	25 mm x 5 m	1/20	5906692015689



PES
2000 kg
38 mm
6m

Ref.	Info	☒	EAN
10-710	38 mm x 6 m	1/20	5906692015696



x2 PES
250 kg
25 mm
2,5m

Ref.	Info	☒	EAN
10-711	25 mm x 2,5 m 2 szt.	25/100	5906692015702



PES
250 kg
25 mm
2,5m

Ref.	Info	☒	EAN
10-712	25 mm x 5 m 1 szt.	25/100	5906692015719

8mm max 14kg 40 cm x2 60 cm x2 80 cm x2 100 cm x2



x8

Ref.	☒	EAN
10-713	1/20	5906692015726

x20 15 cm x4 25 cm x4 30 cm x4 60 cm x4 80 cm x2 100 cm x2



Ref.	☒	EAN
10-714	1/16	5906692015733

x6 max 40kg 60 cm x2 80 cm x2 100 cm x2



Ref.	☒	EAN
10-715	1/20	5906692015740

Pokrowiec ochronny, folia ECO 5w1

Protective cover, ECO foil 5in1 / Schutzhülle, ECO 5in1 Folie / Защитный чехол, фольга ECO 5in1 / Захисна покривка, фольга ECO 5w1 / Védőburkolat, ECO 5in1 fólia / Husa de protectie, folie ECO 5in1 / Ochranný kryt, fólie ECO 5w1 / Ochranný kryt, fólia ECO 5w1 / Zaščitna prevleka, folija ECO 5w1 / Apsauginis dangtelis, ECO 5in1 folija / Aizsargpārvalks, ECO 5in1 folija / Kaitsekate, ECO 5in1 fooliium / Защитно покривне ЕКО фоліо 5w1 / Zaštitna navlaka, ECO 5u1 folija / Защитни покривау, ЕЦО 5у1 фолуја / Funda protectora, lámina ECO 5 en 1

5in1



Ref.	☒	EAN
10-485	0/1	5907558495270

Zestaw pędzelków detailingowych

Detailing brush set / Набор пеналкив для деталізації / Set de perii pentru detalieri / Részletező ecsetkészlet / Set di spazzole per dettagli / Jeu de brosses pour l'entretien / Detailing Pinsel Set / Набор щеток для обработки деталей / Sada detailních štětů / Súprava detailných štetcov / Set četkica za detalje / Detalij šepetelių rinkinys / Detalizēšanas otu komplekts / Komplet čopičev za detalje / Комплект щетки за детаїли / Set четкица за детаље / Σετ πινέλων λεπτομέρειας / Set detailingborstels / Conjunto de escovas de pormenor / Juego de cepillos para detalles / Detailsete pintsliite komplekt



PP
x5

Ref.	☒	EAN
11-462	0/100	5906692019991

Zestaw do regeneracji reflektorów samochodowych

Headlight refurbishment kit / Набор для ремонту фар / Kit de recondiționare a farurilor / Fényszóró felújító készlet / Kit per la manutenzione dei fari / Kit de rénovation des phares / Scheinwerferaufbereitungssset / Набор для восстановления фар / Sada na renovaci světlometů / Sada na obnovu svetlometov / Komplet za obnovu prednjih svetala / Žibintų atnaujijimo rinkinys / Priekšējo lukturu atjaunošanas komplekts / Komplet za pregono žarometov / Комплект за обновяване на фарове / Комплект за реновирање фарова / Kit ανακαίνισης προβολέων / Koplamp revisieset / Kit de renovação de faróis / Kit de renovación de faros / Esilatarnate remondikomplekt



15 elements

Ref.	☒	EAN
10-850	0/42	5907558474565

Wiaderko z separatorem i zakrętką

Bucket with separator and cap / Відро з сепаратором і кришкою / Gäleatü cu separator și capac / Vödör elválasztóval és kupakkal / Secchio con separatore e tappo / Seau avec séparateur et bouchon / Eimer mit Abscheider und Deckel / Ведро с сепаратором и крышкой / Vědro s oddělovačem a víčkem / Vedro s oddelovačom a uzáverom / Kanta sa separatorom i čepom / Kibiras su separatoriumi ir dangteliu / Spainis ar separatoru un vāciņu / Vedro z ločevalnikom in pokrovom / Кофа със сепаратор и капачка / Kanta sa sепаратором и поклопцем / Kouβάς με διαχωριστή και καπάκι / Emmer met afscheider en dop / Balde com separador e tampa / Cubo con separador y tapón / Ámber koos eraldaja ja korgiga



20l
PP

Ref.	☒	EAN
11-463	1/6	5906692020003

Rękawica do mycia auta

Car wash glove / Руквицка для автотмийки / Mănușă pentru spălătorie auto / Autómosó kesztyű / Guanto per autolavaggio / Gant de lavage / Autowaschhandschuh / Перчатка для мойки автомобилей / Rukavice na mytí aut / Rukavica na umývanie auta / Rukavica za pranje automobila / Automobilių ploviklos pirštinė / Auto mazgāšanas cimdš / Rokavica za pranje avtomobila / Ръкавица за миене на автомобили / Руквицка за прање аутомобила / Γάντι πλυντηρίου αυτοκινήτων / Autowashhandschoen / Luva de lavagem de automóveis / Guante de lavado suave / Ūrt autopesuskinnas



28x20cm
extra soft

Ref.	☒	EAN
11-459	1/20	5906692019960

Ściągaczka do wody

Water squeegee / Водяний скребок / Ștergător de apă / Vízlehúzó / Spatola ad acqua / Raclette à eau / Wasserabstreifer / Водяной скребок / Vodní stěrka / Vodná stierka / Brisač vode / Vandens gremžtukas / Ūdens sūcējs / Stiskalnik za vodu / Водна стъркалка / Чустач за воду / Σκουπάκι νερού / Watertrekker / Rodo de água / Escobilla de goma / Veedurve



300mm
TPR
PP

Ref.	☒	EAN
11-457	0/60	5906692019946

Мырка до szyb

Window washer / Мырка до окна / Spălător de geamuri / Ablakmosó / Lavacristalli / Lave-vitres / Scheibenwaschanlage / Мырка до окна / Ostřikovače oken / Umývacia okien / Perač prozora / Langu ploviklis / Logu mazgātājs / Cistilec oken / Мырка до машина за прозорци / Perač prozora / Πλυντήριο παραθύρων / Ruitenwasser / Lavador de janelas / Lavacristales / Aknapesur



400 mm

PES

PP

Ref.	📦	EAN
11-456	1/46	5906692019991



Ref.	📦	EAN
11-458	1/24	5906692019953

Szczotka do mycia auta

Car wash brush / Щетка до миття автомобіля / Perie pentru spălat mașina / Autómosó kefe / Kartáč na mytí auta / Keňa na umývanie auta / Autowaschbürste / Četka za pranje auta / Četka za pranje auta / Spazzola per lavare l'auto / Automobili plovimo šepetys / Auto mazgāšanas birste / Βούρτσα πλυσίματος αυτοκινήτου / Cepillo para lavar coches / Brosse de lavage pour voiture / Autowasborstel / Escova para lavar carro / Щетка до мойки автомобіля / Krtača za potivanje avta



310 mm

80 mm

PP

hard brush

Ref.	📦	EAN
11-450	1/36	5906692019878



430 mm

EVA

PP

soft brush

Ref.	📦	EAN
11-455	1/46	5906692019922



480 mm

AL

PVC

comfort handle

soft brush

Ref.	📦	EAN
11-452	1/24	5906692019892



490 mm

PP

PCV

soft brush

Ref.	📦	EAN
11-454	1/12	5906692019915



250 mm

PP

PCV

soft brush

Ref.	📦	EAN
11-453	1/24	5906692019908



PP

hard brush

Ref.	📦	EAN
11-451	1/50	5906692019885

Ręcznik do osuszania auta

Car drying towel / Рушник до сушіння автомобіля / Prosop de uscare auto / Autószáritó törölköző / Asciugamano per auto / Serviette de séchage pour voiture / Auto-Trockentuch / Полотенце до сушки автомобіля / Ručník na sušení auta / Uterák na sušení auta / Ručník za sušenje automobila / Automobili džiovinimo rankšluostis / Auto žvēšanas dvielis / Brisača za sušenje automobila / Кърпа за сушене на автомобил / Пешкир за сушење аутомобила / Πετσέτα στεγνώματος αυτοκινήτου / Auto droogdoek / Toalla de secagem para automóvel / Toalla para secar el coche / Autot kuivatav rätik



45x38cm

2in1

extra soft

840 g/m²

Ref.	📦	EAN
11-460	1/60	5906692019977

Zestaw ściereczek z mikrofibry

Microfibre cloth set / Набор серпечок з микрофібри / Set de cârpe din microfibră / Mikroszálas kendő készlet / Set di panni in microfibra / Ensemble de chiffons en microfibra / Mikrofasertuch-Set / Ręcznik do osuszania samochodu / Sada utěrek z mikrovlákna / Súprava utierok z mikrovlákna / Set krpa od mikrovlakana / Mikropluošto šluostės rinkinys / Mikroškieđras drānu komplekts / Komplet krp iz mikrovlaken / Комплект кърпи от микрофибър / Set krpe od mikrovlakana / Set πανιών μικροϊνών / Set microvezeldoeken / Conjunto de paños de microfibra / Juego de paños de microfibra / Mikrokiudlapi komplekt



28x20cm

extra soft

x6

Ref.	📦	EAN
11-461	1/24	5906692019984

Etui na klucze do auta blokujące sygnał

Key cases / Ключови кейси / Cazuri-cheie / Kulcsfontosságú esetek / Casi chiave / Principaux cas / Wichtige Fälle / Cazuri-cheie / Klíčové přírady / Klíčové přírady Futrola za ključeve / Pagrindiniai atvejai / Galvenie gadījumi / Ključni primeri / Основни случаи / Кутуја за кључеве / Βασικές περιπτώσεις / Belangrijke gevallen / Casos-chave / Casos clave / Olulisevad juhtumid



RFID

PU

14x
9cm

Ref.	☒	EAN
11-476	1/200	5906692024216

Brelco 6w1

Key ring 6in1 / Schlüsselanhänger 6-in-1 / Кольцо для ключей 6в1 / Брелок для ключів 6в1 / Kulcstartó szerszám 6az1-ben / Breloc 6 în 1 / Přívěsek na klíče 6v1 / Privesok na ključice 6 v 1 / Obesek za ključice 6 v 1 / Raktų rakabukas 6-in-1 / Atslėgų piekariņš 6-in-1 / Нлючодържател 6 в 1 / Μπρελόκ 6 σε 1 / Llavora 6en1 / Portachiavi 6-in-1 / Chaveiro 6-em-1 / Porte-clés 6-en-1 / Sleutelhanger 6-in-1



Ref.	☒	EAN
GD09	250/1000	5907558459876

Szczotka skrobaczka samochodowa do śniegu

Car snow scraper brush / Auto-Schneekratzer-Bürste / Автомобильная щетка для скребка снега / Щітка для чищення снігу для автомобіля / Autó hókaparó kefe / Perie de găzuire a zăpezii pentru mașini / Kartáč na škrabání sněhu do auta / Škrabka na sneh do auta / Krtača za strganje snega v avtomobilu / Automobilinis sniego grandiklio šepetys / Automatišnas sniega skrāpija birste / Auto lumekraarijahari / Четка за почистване на сняг за кола / Četka za čišćenje snijega za automobil / Аутомобилска четка за стругање снега / Βούρτσά ξύστρας χιονού αυτοκινήτου / Cepillo rascador de nieve para coche / Spazzola raschia-neve per auto / Raspador de neve para automóveis / Brosse à neige pour voiture / Auto sneeuwschraper borstel



60
cm

2
in 1

BRUSH
SCRAPER

ERGONOMIC
HANDLE

Ref.	☒	EAN
GD029	1/24	5907558495287

Poduszka podróżna

Car pillow / Tragetasche / Автомобильная подушка / Автомобільна подушка / Autó párná / Pernă pentru mașină / Polštářek do auta / Podložka na prenášanie / Potovadni vzglavnik / Kelioninė pagalvė / Celojumu spilvens / Възглавница за пътуване / Μαξιλάρι ταξιδιού / Cojín para coche para / Neo tools car cushion / Travesseiro de viagem / Oreiller de voyage / Reiskussen



Ref.	☒	EAN
GD016	0/18	5907558472097

Długopis metalowy 5 w 1

Metal pen 5 in 1 / 5-in-1 Metall-Kugelschreiber / Металлическая шариковая ручка 5 в 1 / Металева ручка 5 в 1 / 5 az 1-ben fém golyóstoll / Pix cu bilă din metal 5 în 1 / Kovoné kulíčkové pero 5 v 1 / Kovoné guľôčkové pero 5 v 1 / Kovinsko pisalo 5 v 1 / Metalinis rašiklis "5-in-1 / 5-in-1 metalä lođišu pildspalva / Метална химикалка 5 в 1 / Μεταλλικό στυλό 5 σε 1 / Bolígrafo metálico 5 en 1 / Penna a sfera in metallo 5 in 1 / Esferográfica de metal 5 em 1 / Stylo à bille en métal 5-en-1 / 5-in-1 metalen balpen

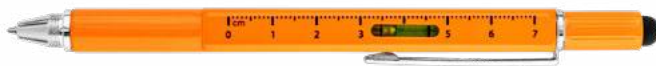

Ref.	☒	EAN
GD024	0/100	5907558484250

Kubek

Mug / Чаша / Миска / Gipszelőedény / Cană / Koflík / Nádoba na sádru PVC / Čaša / Dubuo / Toveris / Tass / Канчок / Pvc posuda / Kadica / Μικρή κούπα / Beker / Bicchiera / Caneca / Bécher



330ml

Ref.	☒	EAN
GD027	6/24	5907558485912
GD028	6/24	5907558485929



400ml

Ref.	☒	EAN
GD08	0/48	5907558458831



Termos

Vacuum flask / Isolierflasche / Термос / Термос / Termosz / Termos / Termoska / Termoska / Termovka / Termosas / Termoss / Termos / Термос / Termos boca / Termos / Βερμός / Termo / Borraccia termica / Garrafa térmica / Thermos / Thermosflles



Ref.	V[ml]	☒	EAN
GD07	1000	0/24	5907558454390

Narzędzie wielofunkcyjne płatek śniegu 19 w 1

Snowflake multi-tool 19in1 / Multifunktionswerkzeug Schneeflocke 19 in 1 / Мультиинструмент Снежинка 19в1 / Мультиинструмент Сніжинка 19в1 / Multifunkciós szerszám hópehely 19az1-ben / Instrument multifuncional fulg de zăpadă 19 în 1 / Multifunkční nástroj sněhová vločka 19 v 1 / Multifunkčný nástroj snehová vločka 19 v 1 / Večnamensko orodje snežinka 19 v 1 / Daugiafunkcinis įrankis snaižė 19 in 1 / Daudzfunkcionāls instruments sniegpārslīpa 19 in 1 / Многофункционален инструмент снежинка 19 в 1 / Πολυλειτουργικό εργαλείο χιονοπλάθα 19 σε 1 / Herramienta multifunción copo de nieve 19 en 1 / Strumento multifunzione fiocco di neve 19 in 1 / Floco de neve de ferramenta multifuncional 19 em 1 / Outil multifonctionnel flocon de neige 19 en 1 / Multifunctioneel gereedschap sneeuwvlok 19 in 1



Ref.	☒	EAN
GD015	0/50	5907558465389

GRAPHITE



Ref.	V[ml]	☒	EAN
GD04	800	0/30	5902062025012
GD05	500	0/50	5902062025029

Zabawki

Toys / Spielsachen / Игрушки / Іграшки / Játékok / Hračky / Hračky / Igrače / Rotallietas / Žaislai / Mänguasjad / Игралки / Juguetes / Giocattoli / Brinquedos / Jouets / Speelgoed



Ref.	☒	EAN
GD010	0/8	5907558459906



GRAPHITE



AGE
3+

2x
AA

Ref.	☒	EAN
GD021	0/24	5902062998262

Narzędzie wielofunkcyjne

Multipurpose tool / Allzweckwerkzeuge / Инструмент универсальный / Інструмент багатofункційний / Multiszerszám / Unealta multifuncionala / Multifunkční nástroj / Viacfunkčné náradie / Večfunkcijsko orodje / Daugiafunkciniai įrankiai / Daudzfunkcionālie instrumenti / Multifunktsionaalne tööriist / Мультифункціонален інструмент / Višenamjenski uređaj / Višefunkcionalne alatke / Πολυεργαλείο / Herramienta multiuso / Utensile multiuso / Aparelho multifunções / Outil multifonction / Multifunctioneel gereedschap



Ref.	W [mm]	⊠	EAN
01-027	105	6/48	5907558420944



Ref.	W [mm]	⊠	EAN
01-026	155	6/36	5907558420937



Ref.	W [mm]	⊠	EAN
01-028	150	6/36	5907558420951



OŚWIETLENIE

workshop lighting освітлення



Latarka

Torch / Taschenlampe / Фонарик / Ліхтарик / Aluminium 2az1-ben zseblámpa/vizsgálólámpa / Lanterna / Bateria / Lampa / Svetilka / Žibintuvėlis / Lukturis / Pōleti / Фенерче / Baterijska / lampa / Lampa / Φακός / Linterna de mano / Torcia / Lanterna / Torche / Zaklamp



3W
300 max lm

- CREE XPE+COB LED
- ALUMINIUM BODY
- BATTERY Li-Ion 3.7V 2000mAh
- 3h charging
- POCKET CLIP
- small size EDC compatible
- ROTATING
- USB charging
- MAGNETIC

Ref.	⊠	EAN
99-034	50/100	5907558451443

1st click:
3% max 60 h

2nd click:
10% max 10 h

3rd click:
40% max 3 h

4th click: OFF

press 2 seconds:
100% max 45 sec.

double click:
STROBE



30W
3300 max lm

- BATTERY Li-Ion 3.7V 4000mAh
- OSRAM P9 LED
- 220 m
- ALUMINIUM BODY
- USB charging cable
- 6h charging
- IPX4

Ref.	⊠	EAN
99-037	20/40	5907558451474

1st click:
100% max 5 h

2nd click:
50% max 10 h

3rd click:
SIDE 100% max 5 h

4th click:
SIDE STROBE

5th click: OFF



10W
800 max lm

- BATTERY Li-Ion 3.7V 2000mAh
- CREE T6+COB LED
- USB charging cable
- ALUMINIUM BODY
- 2in1
- 150 m
- 5h charging
- IP20
- small size EDC compatible

Ref.	⊠	EAN
99-033	0/50	5907558451436

1st click:
100% min 3 h

1st click:
40% max 7 h

2nd click:
10% max 25 h

2nd click:
OFF

click + hold:
STROBE



10W
1000 max lm

- 250 m
- ZOOM
- BATTERY Li-Ion 3.7V 2200mAh
- OSRAM P9 LED
- BATTERY INDICATOR
- USB charging cable
- ALUMINIUM BODY
- 4.5h charging

Ref.	⊠	EAN
99-035	20/40	5907558451450

100% 200lm
2h

50% 100lm
5h

stroboscope

3W
max 200lm

- ZOOM
- CREE XP-E2
- waterproof IPX7 30min
- X3 AAA I
- ALUMINIUM BODY



Ref.	⊠	EAN
99-101	12/72	5907558425482

10W
950 m

- ANODIZED FINISH
- OSRAM LED
- BATTERY Li-Ion 3.7V 4000mAh
- 4h charging
- 3h working
- USB C + cable
- 62.5x 200 mm
- IPX4

500lm



Ref.	⊠	EAN
99-070	4/24	5907558464948

Latarka

Torch / Taschenlampe / Фонарик / Лихтарик / Aluminium 2az1-ben zseblámpa/vizsgálólámpa / Lanterna / Bateria / Lampa / Svetilka / Žibintuvelis / Lukturis / Pöleti / Фенерче / Bateriajska / lampa / Lampa / Φακός / Linterna de mano / Torcia / Lanterna / Torche / Zaklamp

10W
1500LM

200 m

CHARGING TIME
4h

3.7V
4000mAh
Li-Ion

BATTERY INDICATOR

USB C
cable included

SST40 LED

WORKING TIME
2.5h
1500LM

WORKING TIME
3h
900LM

WORKING TIME
7h
350LM

WORKING TIME
9h
200LM



POCKET CLIP

ALUMINIUM BODY

IPX4

Ref.	⊠	EAN
99-075	10/40	5907558464993

20W
2000lm

180 m

CHN LED

CAPACITY & CHARGING INDICATOR

4h charging

ALUMINIUM BODY

BATTERY
Li-Ion
3.7V
2200mAh

USB C
+ cable

ANODIZED FINISH

IPX6

POCKET CLIP



POCKET CLIP

ALUMINIUM BODY

IPX6

Ref.	⊠	EAN
99-067	6/48	5907558464917

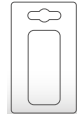

1st click:

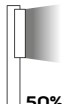

2nd click:

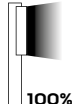

3rd click:

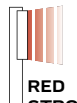

4W
400 max lm

COB LED

x3 AA INCLUDED

POCKET CLIP

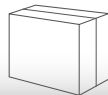

Ref.	⊠	EAN
99-045	50/100	5907558452365

3W
200 max lm

ALUMINIUM BODY

COB LED

x3 AA

IP20

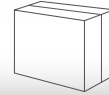

Ref.	⊠	EAN
99-032	0/75	5907558451306

Latarka czołowa

Headlamp / Stirnlampe / Фонарь налобный / Лихтарик начільний / Fejlámpa / Lampă cap / Čelní baterka / Lampra čelová / Čelna svetilka / Žibintuvelis / Lukturitis uz pieres / Esilatern / Лампа за глава / Lampa za glavu / Rucna lampa / Φακός κεφαλής / Linterna de frente / Lampadina frontale / Lanterna de testa / Torche frontale / Hoofdzaklamp

6W
600 max lm

90 m

CREE XPG3 LED

USB magnetic charging cable

small size EDC compatible

2h charging

BATTERY
Li-Ion
3.7V
700mAh

IPX4



1st click:



press 2 seconds:



2nd click:

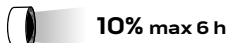

double click:



3rd click: OFF



Ref.	⊠	EAN
99-027	10/80	5907558451252

1st click: 70% max 4 h

2nd click: 45% max 4 h

3rd click: 12% max 6 h

long press: OFF

press fast 2 times:

100% max 2.5 h

+ click 1: STROBE

+ click 2: SOS

long press: OFF

press 2 seconds:

Red

+ click 1: STROBE

+ click 2: Blue

long press: OFF



10W
1000 max lm

200 m

CREE L2 LED

USB charging cable

BATTERY
Li-Ion
3.7V
2000mAh

ALUMINIUM BODY

5h charging

IP20



Ref.	⊠	EAN
99-028	0/50	5907558451269

Latarka czółowa

Headlamp / Stirnlampe / Фонарь налобный / Ліхтарик на чільний / Fejlåmpa / Lampă cap / Čelní baterka / Lampra čelová / Čelna svetilka / Žibintuvelis / Lukturītis uz pieres / Esilatern / Лампа за главо / Lampă za glavu / Rucna lampă / Φακός κεφαλής / Linterna de frente / Lampadina frontale / Lanterna de testa / Torche frontale / Hoofzaklamp

USB C 400 + 400 lumen 100M



Ref. 99-117 1/30 EAN 5907558477603

1st click: 100% max 1.5 h

2nd click: 50% max 3 h

3rd click: STROBE

4th click: OFF

10W 800 max lm USB charging 150 m CREE XML T6 LED ZOOM IP20 BATTERY Li-Ion 3.7V 1200mAh 4h charging



Ref. 99-026 56/112 EAN 5907558451245

1st click: 100%

2nd click: 40%

3rd click: RED

4th click: RED strobe

long press: MOTION SENSOR

3W 180lm COB LED MOTION DETECTOR BATTERY Li-Ion 3.7V 500mAh 50 g ABS BODY RED LIGHT MODE 1.5h charging 2.5h working USB CAP HOOK IPX4 360°



Ref. 99-069 6/48 EAN 5907558464931

350LM XPE+ COB LED MOTION SENSOR 1200mAh Li-Ion 5 LIGHT FUNCTIONS RUBBER BODY WORKING TIME 3-6,5h CHARGING TIME 2.5h cable included USB C 67g IPX4



Ref. 99-097 0/120 EAN 5907558493702

1st click: 40% max 5 h

2nd click: 15% max 9 h

3rd click: 3% max 60 h

4th click: OFF

press 2 seconds: 100% max 40 sec.

double click: STROBE

20W 2000 max lm 200 m CREE X-HP302 LED USB charging cable BATTERY Li-Ion 3.7V 4000mAh ALUMINIUM BODY 6h charging IPX4



Ref. 99-029 10/40 EAN 5907558451276

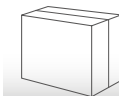

3W 250LM 5 LIGHT FUNCTIONS MOTION SENSOR XPE+ COB LED ADJUSTABLE ANGLE 3.7V 1200mAh Li-Ion CAPHOOK WORKING TIME 4h BATTERY INDICATOR RED LIGHT MODE cable included USB ABS+PC MATERIAL CHARGING TIME 2.5h



Ref. 99-073 25/50 EAN 5907558464979

Latarka czółowa

Headlamp / Stirnlampe / Фонарь налобный / Ліхтарик на чільний / Fejlátpra / Lampă cap / Čelní baterka / Lampa čelová / Čelna svetilka / Žibintuvelis / Lukturītis uz pieres / Esilatern / Лампа за глава / Lampa za glavu / Rucna lamp / Φακός κεφαλής / Linterna de frente / Lampadina frontale / Lanterna de testa / Torche frontale / Hoofdzaklamp

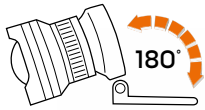

100% 400lm

2h

50% 200lm

5h

stroboscope



5W
max
400lm



CREE
R5

x3
AAA



Ref.	⊠	EAN
99-200	10/40	5907558425505

100% 250lm

3h

50% 125lm

5h

stroboscope



3W
max
250lm



CREE
XPE

x3
AAA



Ref.	⊠	EAN
99-201	0/40	5907558425710

Lampa 3w1

Lamp 3in1 / Lampe 3in1 / Лампа 3 в 1 / Лампа 3in1 / Lámpa 3in1 / Lampă 3in1 / Lampa 3v1 / Lampa 3v1 / Svetilka 3v1 / Lampa 3in1 / Lampa 3n1 / Lamp 3in1 / Лампа 3e1 / Lampa 3u1 / Лампа 3y1 / Lámpa 3e1 / Lámpara 3en1 / Lampada 3in1 / Lâmpada 3 em 1 / Lampe 3en1 / Lamp 3in1



2200mAh
Li-ion
3.7V

3in1

150m
max
range

max
350lm

COB
LED

ZOOM

WORKING
TIME
6-8h

CHARGING
TIME
4h

battery
indicator

quick
easy
change

IP44

cable
included
USB C

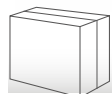

Ref.	⊠	EAN
99-107	0/20	5907558499674



Ref.	⊠	EAN
99-115	12/120	5907558475913

Lampa na szyję

Neck lamp / Nackenlampe / Нашейная лампа / Нашийний світильник / Nyaklámpa / Lampă pentru gât / Lampa na krk / Lampa na krk / Svetilka za vrat / Kaklo lamp / Kakla lamp / Kaela lamp / Лампа за врата / Svjetiljka za vrat / Лампа за врат / Φωτιστικό λαιμού / Lámpara de cuello / Lampada da collo / Lâmpada de pescoço / Lampe de cou



Ref.	⊠	EAN
99-112	0/20	5907558475715

Lampka do kluczy

Key lamp / Schlüssel Lampe / Ключевая лампа / Лампа для ключів / Kulcslámpa / Lampă cu cheie / Kľúčová lamp / Kľúčová lamp / Kľučna svetilka / Pagrindinis žibintas / Galvenais lukturis / Võtte lamp / Ключовая лампа / Лампа за кључеве / Лампа за кључеве / Lámpa kľeidi / Lámpara de llave / Lampada a chiave / Lâmpada de chave / Lampe à clé / Sleutel lamp



Ref.	⊠	EAN
99-109	0/200	5907558499728

Lampa warsztatowa

Workshop lamp / Werkstattlampe / Лампа переносная / Лампа переносна / Steklámpa / Lampă atelier / Dílenská lampa / Dielenská lampa / Delavniška svetilka / Lampa dirbtuvėms / Pārņēsājamā lampa / Töökoja lamp / Лампа работна / Radna lampa / Radna lampa / Λάμπα εργαστηρίου / Lámpara de taller / Lampada da officina / Lämpada de oficina / Lampe d'atelier / Werkplaatslamp



1st click: 100% max 1.5 h
2nd click: 50% max 3 h
3rd click: 100% max 3 h
4th click: OFF
press 2 seconds: RED LIGHT max 3 h
+ click 1: RED STROBE
+ click 2: OFF

3W
200 max lm

COB LED

2in1 LAMP + TORCH

BATTERY Li-Ion 3.7V 1200mAh

FOLDING

4h charging

IP20

USB charger + cable

Ref.	⊠	EAN
99-041	0/50	5907558452327



10+3 W W
500+150 LM LM

2in1 LAMP + TORCH

COB LED

POWERBANK

RED LIGHT MODE

CHARGING TIME 3.5h

WORKING TIME 3h 4h



3.7V 2000mAh Li-Ion

BATTERY INDICATOR

HANGING HOOK x2

IP20

Ref.	⊠	EAN
99-072	25/50	5907558464962

1st click: 100% max 2h
2nd click: 30% max 7h
3rd click: OFF

8W
600 max lm

10W
900 max lm

FOLDABLE HOOK

SMD LED

BATTERY Li-Ion 3.7V 2200mAh

USB 5V/1A CHARGER INCLUDED

ABS

600 lm

4h charging

IMPACT RATING IK08

SMD LED

6500 K

25000h work time

IP54

ABS

LEDs x24

363x50x50 mm

IMPACT RATING IK08

CRI Ra≥80

CABLE 5m EU socket

H05RN-F2 x1,0mm²

230V 50Hz

Ref.	⊠	EAN
99-043	0/24	5907558452341
99-044	0/16	5907558452358



5W+1W
500 lm

CHARGER INCLUDED

2in1 lamp + torch

DIMMING

COB LED

CAPACITY INDICATION

BATTERY Li-Ion 3.7V 2600mAh

HOOK

MAGNETIC

3.5h charging

2-2.5h working

ABS BODY

270x90x80 mm

USB C charger + cable

IP20

Ref.	⊠	EAN
99-065	0/20	5907558464894



1st click: max 3.5 h
2nd click: OFF
3rd click: max 6 h
4th click: OFF

300 lm

2in1 LAMP + TORCH

COB LED

x3 AA INCLUDED

ABS

360° ADJUSTABLE STAND

Ref.	⊠	EAN
99-042	0/24	5907558452334



10+5 W W
550+150 LM LM

2in1 LAMP + TORCH

COB LED

CHARGER INCLUDED

RED LIGHT MODE

DIMMING

360°

CHARGING TIME 3h

WORKING TIME 3h 3.5h

3.7V 2000mAh Li-Ion

BATTERY INDICATOR

HANGING HOOK x2

IP20

Ref.	⊠	EAN
99-071	10/20	5907558464955

Lampa warsztatowa

Workshop lamp / Werkstattlampe / Лампа переносная / Лампа переносна / Steklámpa / Lampă atelier / Dílenská lamp / Díelenská lamp / Delavniška svetilka / Lampa dirbtuvėms / Pārņēsjamā lamp / Töökoja lamp / Лампа работна / Radna lamp / Radna lamp / Λάμπα εργαστηρίου / Lámpara de taller / Lampada da officina / Lámpada de oficina / Lampe d'atelier / Werkplaatlamp



6W
500lm

BATTERY Li-ion 3.7V 2400mAh

COB LED

HOOK

FOLDING CONSTRUCTION

3-4h charging

ABS BODY

max 4h (50%) working

400x65x52 mm

IP20

Ref.	⊠	EAN
99-066	0/20	5907558464900

Lampa komory silnika

Engine compartment lamp / Лампа для моторного відсіку / Lampă camere motor / Műhely-vízsgólámpa motortérbe / Lampada del vano motore / Lampe du compartiment moteur / Leuchte für Motorkammer / Перезаряджаемый светильник моторного отсека / Svítlna motorového priestoru / Svetidlo motorového priestoru / Svjetlo motornog prostora / Variklio skyriaus lemputė / Dzinēja nodalījuma lukturis / Svetilka motornega prostora / Лампа в двигателното отделение / Лампа u motornom prostoru / Λαμπτήρας χώρου κινητήρα / Lamp motorruimte / Luz do compartimento do motor / Luz del compartimento del motor



2x350 lm
700 max lm

2x 4.5W

4000 K

2x BATTERY Li-ion 3.7V 2200mAh

SMD LED

2h work time

2h charging

CHARGER INCLUDED

x6

Ref.	⊠	EAN
99-047	0/8	5907558452389

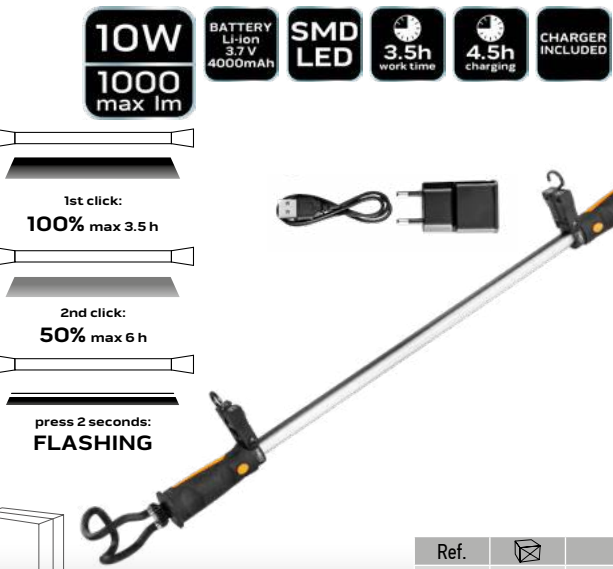

10W
1000 max lm

BATTERY Li-ion 3.7V 4000mAh

SMD LED

3.5h work time

4.5h charging

CHARGER INCLUDED

x4

1st click:
100% max 3.5h

2nd click:
50% max 6h

press 2 seconds:
FLASHING

FOLDABLE HOOPS with magnets

ADJUSTABLE HOLDERS 190 - 200 cm

Ref.	⊠	EAN
99-048	1/4	5907558452396



2in1 CHARGER INCLUDED

COB LED

4W+ 1W LAMP+ TORCH

max 400lm

torch ABS

3.7V 2200mAh Li-ion

cable included USB C

CHARGING TIME 3-3.5h

WORKING TIME 4-4.5h for 50% brightness

IP20 IK07

battery indicator

HOOK

Ref.	⊠	EAN
99-102	0/10	5907558495478

Lampa szperacz

Searchlight / Suchscheinwerfer / Прожектор / Прожектор / Fényező / Reflector / Světlo / Svetlo / Žaromet / Prožektorius / Prožektors / Prožektor / Прожектор / Reflektor / Рефлектор / Προβολέας / Reflector / Proiettore / Holofote / Projecteur / Zoeklicht



1000lm

8h working

ABS

2x Li-ion 3.7V 2200mAh

6h charging

RANGE 350m

IP44

USB C

SST40 LED

USB C cable included

STROBE function

Ref.	⊠	EAN
99-114	0/20	5907558475265

Flara drogowa

Traffic flare / Straßenfackel / Дорожная вспышка / Дорожная сигнальная ракета / Közúti fáklya / Explozie rutieră / Silniční světlíce / Cestná svetlica / Cestna bakla / Kelio signalinė raketė / Ceļa signālrakete / Maantee põletus / Светкавица на пътя / Cestovna baklja / Путна бакља / Обикύ флотови́ба / Llamarada de carretera / Bandiera stradale / Foco na estrada / Feu de route / Wegfakkel



12+3 LED

5 MODES

Flashlights + lamp

x3 AAA

Ref.	⊠	EAN
99-128	40/80	5906692019076

Naświetlacz

Floodlight / Scheinwerfer / Прожектор / Прожектор / Dízskivilágítás / Projector / Světlo / Svetlo / Reflektor / Prožektorius / Floodlight / Floodlight / Прожектор / Reflektor / Φοοδλυεχμ / Προβολέας / Luz de inundación / Proiettore / Floodlight / Projecteur / Schijnwerper

1st click:



100%

2nd click:



50%

3rd click:



STROBE

4th click: OFF



10W
750
max lm

COB LED

HANDLE/
SUPPORT

ABS

IP20

POWER BANK

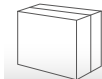

Zasilane 3xAA lub 2x18650
Powered by 3xAA or 2x18650
Работает на 3xAA или 2x18650

Ref.	☒	EAN
99-038	0/40	5907558452297

30W
3000
max lm

POWER BANK

CHARGER INCLUDED

SMD LED

BATTERY Li-ion 3.7 V 8000mAh

ABS + AL

CAPACITY INDICATION

USB C charger + cable

4.5h charging

ADJUSTABLE SUPPORT

TRANSPORT HANDLE

IP54

210x 180x 55 mm

1st click:

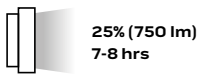

25% (750 lm)
7-8 hrs

2nd click:



50% (1500 lm)
4 hrs

3rd click:

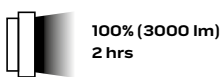

100% (3000 lm)
2 hrs

4th click: OFF



Ref.	☒	EAN
99-064	0/10	5907558464887

1st click:
Large LED
100% max 2 h

2nd click:
Small LED
100% max 5 h

3rd click: OFF
press 3 seconds:
Both LEDs
100% max 2 min

750
+250
max lm

10W +3W

CREE +CREE XPG LED

HANDLE/SUPPORT

POWER BANK

BATTERY Li-ion 3.7 V 2600mAh

ABS + TPR

USB charger + cable

4.5h charging

IP20



Ref.	☒	EAN
99-040	10/20	5907558452310

Latarka inspekcyjna + laser + UV

Inspection lamp + laser + UV / Inspektionslampe + Laser + UV / Инспекционная лампа + лазер + УФ / Инспекційна лампа + лазер + УФ / Ellenőrző lámpa + lézer + UV / Lampa de inspectie + laser + UV / Inspekční lampa + laser + UV / Inšpekčná lampa + laser + UV / Inšpekcijska svetilka + laser + UV / Αρχιτύρος lempa + lazeris + UV / Párbaudes lampa + lázers + UV / Kontrolllamp + laser + UV / Инспекционная лампа + лазер + UV / Inspekcijska lampa + laser + UV / Inspekcijska lampa + laser + UV / Λάμπα επιθεώρησης + λέιζερ + UV / Lámpara de inspección + láser + UV / Lampada di ispezione + laser + UV / Lâmpada de inspeção + laser + UV / Lampe d'inspection + laser + UV / Inspectielamp + laser + UV

450lm
+ 140lm



4in1

LAMP + TORCH

DIMMING

COB LED

LASER

365nm UV

cable included USB C

ALUMINUM BODY

MAGNETIC POCKET CLIP

CHARGING TIME 3h

WORKING TIME 2.5h

3.7V 800mAh Li-Ion

BATTERY INDICATOR

5W + 3W

165mm x 23mm

IP20



Ref.	☒	EAN
99-077	50/100	5907558465013

Lampa + trójkąt ostrzegawczy

Lamp + warning triangle / Lampe + Warndreieck / Лампа + предупреждающий треугольник / Лампа + трикутник попередження / Lámpa + figyelmeztető háromszög / Lampă + triunghi de avertizare / Lampa + výstražný trojuholník / Lampa + výstražný trojuholník / Svetilka + opozorilni trikotnik / Lampa + isprėjamasis trikampis / Lampa + brīdinājuma trīsstūris / Lamp + hoiatusnurk / Лампа + предупредителен триъгълник / Lampa + trokut upozorenja / Лампа + троугао упозорења / Λάμπα + προειδοποιητικό τρίγωνο / Lámpara + triángulo de advertencia / Lampada + triangolo di emergenza / Lâmpada + triângulo de advertência / Lampe + triangle de présignalisation / Lamp + gevarendriehoek

1st click:

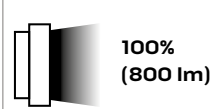

100%
(800 lm)

10W
800
max lm

COB LED

RUBBER POINTS

ADJUSTABLE HANDLE/SUPPORT

2nd click:

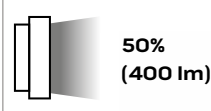

50%
(400 lm)

x4 AA NOT INCLUDED

NYLON +TPR BODY

220x 220x 45 mm

3rd click:



RED
STROBE

4th click: OFF



Ref.	☒	EAN
99-076	5/10	5907558465006

Lampa akumulatorowa

Lampa akumulatorowa / Battery lamp / Аккумуляторная лампа / Lampă cu baterie / Akkumulátoros lámpa / Lampada a batteria / Lampe à piles / Akku-Lampe / Аккумуляторная лампа / Bateriová lampa / Batériová lampa / Pujniva lampa / Akumulátorius lempa / Akumulatora lukturis / Baterijska svetilka / Лампа за батерию / Пуњива лампа / Λαμπτήρας μπαταρίας / Acculamp / Lâmpada de bateria / Lámpara de batería / Akulamp

2000 lm 4400 mAh USB-C charging cable X4 POWER BANK M6 WORK during charging



Ref.	📦	EAN
99-125	1/10	5906692019533

1400 lm 4000 mAh USB-C charging cable POWER BANK WORK during charging



Ref.	📦	EAN
99-126	1/10	5906692019540



5000lm 5000mAh battery
max 2m cable included USB C
charger 3A 6500K
IK07 CRI: 80



Ref.	📦	EAN
99-121	1/2	5906692017560



4in1 lamp flashlight compressor window hammer 2 000 mAh
MAX 8.5 BAR 800 400 lm
RED LIGHT COB LED
BATTERY INDICATOR IP20
USB-C charging cable

Ref.	📦	EAN
99-130	1/5	5906692019069



Lampa do inspekcji lakieru

Paint inspection lamp / Inspektionslampe für Farbe / Лампа для проверки лакокрасочного покрытия / Лампа для перевірки фарби / Festékellenőrző lámpa / Lampă de inspecție a vopselei / Kontrolní lampá na nátěry / Lampa na kontrolu farby / Svetilka za pregled barve / Dažų tikrinimo lempa / Krāsas pārbaudes lampa / Värvikontroll-lamp / Лампа за проверка на боята / Lampa za pregled boje / Лампа за преглед боје / Λαμπτήρας επιθεώρησης βαφής / Lampada di ispezione della vernice / Lâmpada de inspecção da pintura / Lámpara de inspección de pintura / Lampe d'inspection de la peinture / Verf inspectielamp



Ref.	☒	EAN
99-098	0/10	5907558493719

Lampa 360 stopni

Lamp 360 degrees / 360-Grad-Lampe / Лампа 360 градусов / Лампа на 360 градуса / Lámpa 360 fokok / Lampă de 360 de grade / Lampá 360° / Lampá 360° / Svetilka 360-stopijnjska / Lampa 360 laipsnių / Lampa 360 grādu / Lamp 360 kraadi / Лампа 360-градусова / Lampa 360 stupnjeva / Лампа 360 степени / Λαμπτήρας 360 μοιρών / Lampada a 360 gradi / Lampadina frontale / Lámpara de 360 grados / Lampe 360 degrés / Lamp 360 graden



Ref.	☒	EAN
99-099	0/2	5907558495461



Lampa warsztatowa

Workshop lamp / Werkstattlampe / Лампа переносная / Лампа переносна / Stekklámpa / Lampă atelier / Dílenská lampa / Díelenská lampa / Delavniška svetilka / Lampa dirbtuvems / Pārnēsājama lampa / Tōkojia lamp / Лампа работна / Radna lampa / Radna lampa / Λύμπα εργαστηρίου / Lámpara de taller / Lampada da officina / Lâmpada de oficina / Lampe d'établi / Werkplaatslamp



Ref.	☒	EAN
99-124	1/8	5906692019526

Lampa z czujnikiem ruchu

Lamp with motion sensor / Лампа с датчиком движения / Лампа cu senzior de mişcare / Lámpa mozgásérzékelővel / Лампа з датчиком руху / Svetidlo so snímačom pohybu / Lampa se snímačom pohybu / Lampe mit Bewegungssensor / Svetilka s senzorjem gibanja / Lampa su judesio jutikliu / Lampa ar kustības sensoru / Liikumisanduriga lamp / Лампа със сензор за движение / Svetiljka sa senzorom pokreta / Лампа са сензором покрета / Λάμπα με αισθητήρα κίνησης / Lámpara con sensor de movimiento / Lampada con sensore di movimento / Lâmpada com sensor de movimento / Lampe avec détecteur de mouvement / Lamp met bewegingssensor



230V 50Hz	SMD LED	MOTION DETECTOR 10m	NO DIMM
60 % <0.5s	30000h work time	CRI Ra≥70	6500 K
-20°< >40°	BEAM ANGLE >100°	CABLE 15cm	ALUMINIUM BODY
PF>0.9	ON/OFF ≥15000	IP65	



Ref.	P [W]	[lm]	☒	EAN
99-049	30	2400	0/20	5907558452464
99-050	50	5000	0/10	5907558452471

Lampa

Lamp / Lampe / Лампа / Лампа / Lámpa / Lampä / Lampa / Lampa / Svetilka / Lempa / Lampa / Lamp / Лампа / Lampa / Lampa / Λάμπα / Lámpara / Lampada / Lâmpada / Lampe / Lamp /

SMD LED	50W 4500 max lm	230V 50Hz	CABLE 2m EU plug	BEAM ANGLE >120°	6500 K	25000h work time
60 % <1.0s	ON/OFF ≥15000	CRI Ra≥80	PF>0.9	-25°< >45°	NO DIMM	IP65

SMD LED	230V 50Hz	30000h work time	6500 K	ALUMINIUM BODY	IP65	BEAM ANGLE >100°
CRI Ra≥70	60 % <0.5s	ON/OFF ≥15000	CABLE 15cm	NO DIMM	-40°< >50°	PF>0.8



Ref.	P [W]	[lm]	☒	EAN
99-063	50	4500	0/10	5907558452600



Ref.	P [W]	[lm]	☒	EAN
99-093	10	800	0/60	5907558469547
99-051	20	1600	0/40	5907558452488
99-052	30	2400	0/30	5907558452495
99-053	50	4000	0/20	5907558452501
99-054	100	8000	0/10	5907558452518

Lampa

Lamp / Lampe / Лампа / Лампа / Lámpa / Lampă / Lampa / Lampa / Svetilka / Lampa / Lampa / Lamp / Лампа / Lampa / Lampa / Lámpa / Lámpara / Lampada / Lâmpada / Lampe / Lamp

100W 8500 lm	230V 50Hz	SMD LED	6500 K	BEAM ANGLE >110°	-25° < >45°	ON/OFF ≥15000
25000h work time	CRI Ra ≥ 80	60% <1s	max 1.8m	NO DIMM	CABLE 3m	DF>0.9 IP65



Ref.	P [W]	[lm]	☒	EAN
99-095	100	8500	0/2	5907558469561

SMD LED	H 1.8 m MAX	6500 K	25000h work time
230V 50Hz	BEAM ANGLE >120°	60% <1.0s	PF>0.9
CRI Ra≥80	CABLE 3m EU plug	NO DIMM	-25° < >45°
ON/OFF ≥15000	IP65		



Ref.	P [W]	[lm]	☒	EAN
99-059	30	2700	0/4	5907558452563
99-060	50	4500	0/4	5907558452570

2x100W 16400 lm	230V 50Hz	SMD LED	6500 K	ON/OFF ≥15000	25000h work time
BEAM ANGLE >110°	-25° < >45°	CRI Ra ≥ 80	max 1.8m	CABLE 3m	60% <1s
NO DIMM	DF>0.9	ON/OFF switch	IP65		



Ref.	P [W]	[lm]	☒	EAN
99-096	200	8500	0/2	5907558469578

230V 50Hz	SMD LED	H 1.8 m MAX	BEAM ANGLE >120°
6500 K	25000h work time	60% <1.0s	PF>0.9
-25° < >45°	NO DIMM	CRI Ra≥80	CABLE 3m EU plug
ON/OFF ≥15000	IP65		



Ref.	P [W]	[lm]	☒	EAN
99-061	2x 30	5400	0/4	5907558452587
99-062	2x 50	9000	0/4	5907558452594

ELEKTRONARZĘDZIA

power tools

електроінструмент



Wiertarko-wkrętarka akumulatorowa

Cordless drill / Akkuboehrschrauber / Дрель-шуруповерт аккумуляторная / Дрель-шуруповерт аккумуляторный / Akkus ütvefúró / Vormasina-surubelita cu acumulator / Akumulátorová vrtačka-šroubovák / Akumulátorový vrtací skrutkovač / Akumulatorski vrtalnik-vijačnik / Akumulatorinis grežtuvas - sukutvas / Akumulatora urbjmašina-skrūvgriezis / Akutrell / Аккумуляторен пробоеен винтоверт / Akumulatorska bušilica - izvijač / Akumulatorska bušilica - odvijač / Επαναφορτιζόμενο βραχάνο-κατσάβιδο / Taladradora atornilladora a batería / Trapano avvitatore a batteria con percussione / Aparafuradora de batería / Perceuse-visseuse à batterie / Accu boor-draaimachine



2 - 13 mm



18V 2Ah
Li-Ion



I: 0-500 min⁻¹
II: 0-1700 min⁻¹



1-16
+ drilling



38 Nm



58 Nm



Ref.	Ⓜ [kg]	📦	EAN
58G020-SET2	5,06	0/4	5902062503688



0,8 - 10 mm



18V 2Ah
Li-Ion



I: 0-350 min⁻¹
II: 0-1250 min⁻¹



19+1
positions



28 Nm



44 Nm



BRUSHLESS
MOTOR



2 - 13 mm



18V 2Ah
Li-Ion



I: 0-500 min⁻¹
II: 0-1700 min⁻¹



16 + 2
positions



I: 0-7500 min⁻¹
II: 0-25500 min⁻¹



38 Nm



58 Nm



Ref.	Ⓜ [kg]	📦	EAN
58G000-SET1	5,06	1/5	5902062503633

Ref.	Ⓜ [kg]	📦	EAN
58G020	5,06	1/5	5902062045959

Wiertarko-wkrętarka akumulatorowa

Cordless drill / Akkubohrschrauber / Дрель-шуруповерт аккумуляторная / Дрель-шуруповерт аккумуляторный / Akkus útvefúró / Vormasina-surubelmita cu acumulator / Akumulátorový vrtačka-šroubovák / Akumulátorový vrtací skrutkovač / Akumulatorski vrtalnik-vijačnik / Akumulatorinis gręžtuvas - sukutvas / Akumulatora urbjmašina-skrūvgrēzis / Akutrell / Аккумуляторен пробивен винтоверт / Akumulatorska bušilica - izvijač / Akumulatorska bušilica - odvijač / Εναρφαρτιζόμενο βραχάνο-κατάρτιδο / Taladradora atornilladora a batería / Trapano avvitatore a batteria con percussione / Aparafuradora de batería / Perceuse-visseuse à batterie / Accu boor-draaimachine



QUICK CHUCK



HEX SOCKET



0,8 - 10 mm



18V 2Ah
Li-Ion



I: 0-350 min⁻¹
II: 0-1250 min⁻¹



19+1
positions



28 Nm



44 Nm



Ref.	[kg]	⊠	EAN
58G022	5,06	1/5	5902062045973



QUICK CHUCK



HEX SOCKET



0,8 - 10 mm



18V 2Ah
Li-Ion



I: 0-350 min⁻¹
II: 0-1250 min⁻¹



19+1
positions



28 Nm



44 Nm



Ref.	[kg]	⊠	EAN
58G022-AD	5,06	1/5	5902062065339



2 - 13 mm



18V
Li-Ion



I: 0-350 min⁻¹
II: 0-1250 min⁻¹



I: 0-5250 min⁻¹
II: 0-18750 min⁻¹



1 - 16 + drilling
+ impact
drilling



35 Nm



55 Nm



Ref.	[kg]	⊠	EAN
58G010	1,3	0/5	5902062035387



BRUSHLESS
MOTOR



2 - 13 mm



18V
Li-Ion



I: 0-500 min⁻¹
II: 0-1700 min⁻¹



1 - 16 +
drilling



38 Nm



58 Nm



Ref.	[kg]	⊠	EAN
58G019	1,2	0/5	5902062045942

Wiertarko-wkrętarka akumulatorowa

Cordless drill / Akkubohrschräuber / Дрель-шуруповерт аккумуляторная / Дрель-шуруповерт аккумуляторный / Akkus ütvejfúró / Bormasina-surubelnita cu acumulator / Akumulátorová vrtačka-šroubovák / Akumulátorový vrtací skrutkovač / Akumulatorski vrtalnik-vijačnik / Akumulatorinis gręžuvas - suktuvas / Akumulatora urbjmašina-skrūvgriezis / Akutrell / Акумуляторен пробивен винтоверт / Akumulatorska bušilica - izvijač / Akumulatorska bušilica - odvijač / Επαναφορτιζόμενο βραχάνο-κατσάβιδο / Taladradora atornilladora a batería / Τραπανο αβιτatore a batteria con percussione / Aparafuradora de batería / Perceuse-visseuse à batterie / Accu boor-draaimachine

ENERGY+
system

NEO GRAPHITE

compact
size



BRUSHLESS
MOTOR



2 - 13 mm



18V
Li-Ion



20+1 drilling
+impact drilling



I: 0-320 min⁻¹
II: 0-1700 min⁻¹



I: 0-4800 min⁻¹
II: 0-25500 min⁻¹



70 Nm



max
95 Nm



Ref.	[kg]	⊠	EAN
04-619	1,17	0/5	5907558498189

ENERGY+
system

NEO GRAPHITE



BRUSHLESS
MOTOR



2 - 13 mm



18V
Li-Ion



I: 0-480 min⁻¹
II: 0-1900 min⁻¹



1-24 + drilling
+impact drilling



I: 0-7680 min⁻¹
II: 0-30400 min⁻¹



75 Nm



max
100 Nm



Ref.	[kg]	⊠	EAN
04-616	1,56	1/5	5907558484595

ENERGY+
system

NEO GRAPHITE



BRUSHLESS
MOTOR

compact
size



0.8 - 10 mm



18V
Li-Ion



20+1
positions



I: 0-400 min⁻¹
II: 0-1350 min⁻¹



35 Nm



max
55 Nm



Ref.	[kg]	⊠	EAN
58GE139	1,2	0/5	5902062169297

Wiertarko-wkrętarka sieciowa

Electric screwdriver / Netzschrauber / Дрель-шуруповерт электрическая / Шрубоверт мережевий / Elektromos csavarhúzó / Surubelnita electrica / Elektrická vrtačka / Elektrický skrutkovač / Električni vijačnik / Elektrinis suktuvas / Tikla skrūvgriezis / Elektriline krivikeeraja / Мрежова бормашина / Električna bušilica / Električna bušilica / Ηλεκτρικό βραχάνο-κατσάβιδο / Atornillador eléctrico / Avvitatore elettrico / Máquina de pôr parafusos / Visseuse réseau / Elektrische boormachine



300W



230V- 50Hz



I: 0-400 min⁻¹
II: 0-1600 min⁻¹



0.8 - 10 mm



22+1 positions



left-right



6 m



Ref.	[kg]	⊠	EAN
58G793	1,39	1/4	5902062087805

Zakrętarka akumulatorowa ENERGY+

Cordless driver / Akku-Schraubmaschine / Гайковерт аккумуляторный / Мутроверт аккумуляторный / Akkus ütvecsavarozó / Inchizător de acumulator / Akumulátorový šroubovák / Akumulátorový šroubovák / Akumulatorski vrtnalnik / Akumuliatorinis suktuvas / Akumulatora uzvāznis / Keermepuur / Ударен гайковерт / Akumulatorski zavijač / Akumulatorski navojni čep / Επιναφορτιζόμενο καταβίδι / Dispositivo de cierre a batería / Avvitatore a batteria ad impulsi / Máquina de travar com bateria / Visseuse à batterie / Accu schroefmachine



6.35mm (1/4") 18V Li-Ion



0-2200 min⁻¹ 180 Nm

Ref.	[kg]	⊠	EAN
58G012	1,2	0/5	5902062035400



BRUSHLESS MOTOR



6.35mm (1/4") 18V Li-Ion



I. 0-1000 min⁻¹ I. max 80 Nm
II. 0-1800 min⁻¹ II. max 120 Nm
III. 0-2700 min⁻¹ III. max 200 Nm

Ref.	[kg]	⊠	EAN
58G024	1,1	0/5	5902062059765



compact size



18V Li-Ion



BRUSHLESS MOTOR



6.35mm (1/4")



max 300 Nm



I. 0-1500 min⁻¹
II. 0-2500 min⁻¹
III. 0-3200 min⁻¹
IV. 0-3600 min⁻¹



I. max 45 Nm
II. max 120 Nm
III. max 210 Nm
IV. max 270 Nm

Ref.	[kg]	⊠	EAN
04-612	0,9	0/5	5907558465600

Wiertarka udarowa

Impact drill / Bohrhämmer / Дрель ударная / Дрель ударный / Útvefúró / Perforator de lovit / Příklepová vrtačka / Příklepová vrtačka / Udarni vrtnalnik / Grežtuvas su kalimu / Sitiena urbimāšina / Löökdrill / Бормашина ударна / Udarna bušilica / Udarna busilica / Κρουστικό δράπανο / Taladro de impacto / Trapano a percussione / Berbequim de impacto / Perceuse à choc / Slagboommachine



1050W



230V- 50Hz



I: 0-1100 min⁻¹
II: 0-3000 min⁻¹



1.5 - 13 mm



I: 0-17600 min⁻¹
II: 0-48000 min⁻¹



max 16 mm



max 13 mm



max 40 mm



Ref.	[kg]	⊠	EAN
58G722	5,4	0/4	5902062024251

Grzechotka akumulatorowa

Cordless ratchet / Schnurlose Ratsche / Аккумуляторная трещотка / Аккумуляторна тріскачка / Akkus racsni / Clichet fără fir / Akumulátorová ráčna / Akumulátorová ráčna / Akumulatorska rrvrtavka / Akumuliatorinis reketas / Bezvadu tarkšķis / Juhtmeta ratas / Аккумуляторна трещотка / Bežična čegrtaljka / Аккумуляторска чегрталъна / Ασύρματη καστίνα / Carraca inalámbrica / Cricchetto a batteria / Catraca sem fio / Cliquet sans fil / Draadloze ratel



NEO GRAPHITE



BRUSHLESS MOTOR



60 Nm

0-250 min⁻¹

3/8"



3/8"-1/2"

Ref.	[kg]	⊠	EAN
04-603	0,9	1/20	5907558465525



Klucz udarowy akumulatorowy ENERGY+

Impact wrench / Schlagschlüssel / Ключ ударный / Мутроверт ударный / Útvecsavarozó / Cheie cu percuție / Rázový utahovák / Priklepový kľúč / Udarni vijačnik / Atskėlimo plaktukas / Sitama atslėga / Löökvõti / Ударен ключ / Udarni ključ / Pneumatski ključ / Κλειδί κρούσης / Llave de impacto / Avvitatore ad impulsi / Chave de impacto / Clef à choc / Slagsleutel

ENERGY+
system

NEO GRAPHITE



Ref.	[kg]	⊠	EAN
58G018	1,8	0/5	5902062045935

ENERGY+
system

NEO GRAPHITE

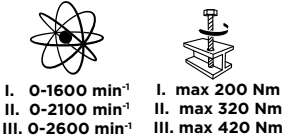
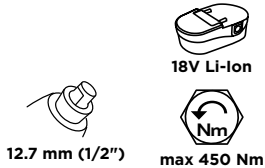

Ref.	[kg]	⊠	EAN
58G038	1,25	0/5	5902062089076

ENERGY+
system

NEO GRAPHITE

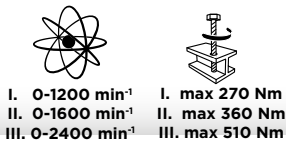
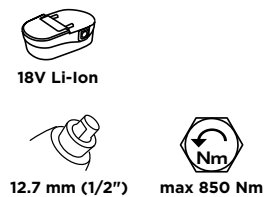

Ref.	[kg]	⊠	EAN
04-608	1,83	0/5	5907558410761

ENERGY+
system

NEO GRAPHITE

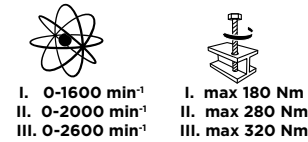
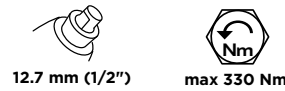

Ref.	[kg]	⊠	EAN
58G028-1	0,9	1/5	5902062172013

ENERGY+
system

NEO GRAPHITE

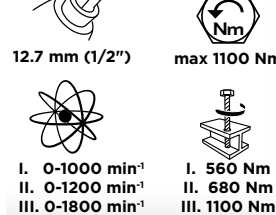

Ref.	[kg]	⊠	EAN
04-618	3,01	1/4	5907558495973

ENERGY+
system

NEO GRAPHITE

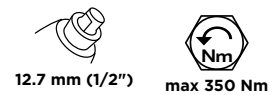

Ref.	[kg]	⊠	EAN
04-613	1,1	0/5	5907558465617

Klucz udarowy

Impact wrench / Schlagschlüssel / Ключ ударный / Муртоверт ударный / Útvecsavarozó / Cheie cu percucie / Rázový utahovák / Priklepový kľúč / Udarni vijajačnik / Sitama atslēga / Celtniecības fēns / Löökväti / Ударен ключ / Udarni ključ / Pneumatski ključ / Κλειδί κρούσης / Llave de impacto / Avvitatore ad impulsi / Chave de impacto / Clef à choc



Szlifierka kątowa akumulatorowa ENERGY+

Cordless angle grinder / Winkelschleifer / Аккумуляторная угловая шлифовальная машина / Шліфмашинка кутова (болгарка) / Akkus sarokcsiszoló / Masina de slefuit unghiulara / Úhlová bruska / Uhlová brúska / Kotni brusilnik / Кампинис шліфуокліс / Leņķa slīrtašīna / Nurklīhvija / Ёлошлайф / Kutna brusilica / Ugaona brusilica / Γωνιακό τρίψείο / Amoladora angular / Smerigliatrice angolare / Disco de limar p. cantos / Meuleuse d'angle / Versteckschuermachine

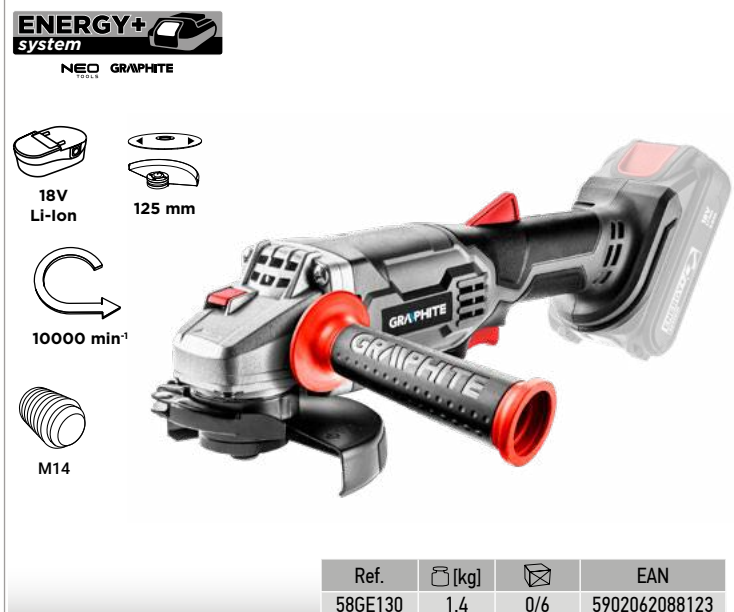

Szlifierka kątowa

Angle grinder / Winkelschleifer / Шлифмашина угловая / Шліфмашинка нарізна / Sarokcsiszoló / Maşină unghiulară de şlefuit / Bruska úhlová / Brúška uhlová / Kotni brusilnik / Kampinis šlifuoklus / Leŕka slípmášina / Nurklithija / Βελοναίφ / Brusilica kutna / Brusilica ugaona / Γωνιακός τροχός / Amoladora angular / Smerigliatrice angolare / Disco de limar p. cantos / Meuleuse d'angle / Versteckschuurmachine

750W 230V- 50Hz
3000-12000 min⁻¹
125 mm
M14

Ref.	[kg]	⊠	EAN
59G175	2,08	1/6	5907558480740

750W 230V- 50Hz
12000 min⁻¹
115 mm
M14

Ref.	[kg]	⊠	EAN
59G063	2,5	1/6	5902062024336

900W 230V- 50Hz
125 mm
12000 min⁻¹
M14

Ref.	[kg]	⊠	EAN
59G087	2,5	1/6	5902062024343

2600W
230V- 50Hz
230 mm 6500 min⁻¹ M14

Ref.	[kg]	⊠	EAN
59G208	6,9	1/2	5902062034663

1000W
230V- 50Hz
125 mm
3000-12000 min⁻¹
M14

Ref.	[kg]	⊠	EAN
04-716	2,0	0/6	5907558465303

3000W
230V- 50Hz
230 mm
6600 min⁻¹
M14

Ref.	[kg]	⊠	EAN
04-715	5,5	0/2	5907558498202

Urządzenie wielofunkcyjne

Multi-function tool / Mehrfunktionsgerät / Многофункциональный инструмент / Багатофункційний пристрій / Többfunkciós berendezés / Dispositiv multifuncțional / Multifunkční zařízení / Multifunkčné zariadenie / Večfunkcijska naprava / Daugjāfunkcinis ierānis / Daudzfunkcionālā iekārta / Multifunktsionaalne seade / Мультифункционално устройство / višenamjenski uređaj / Višefunkcionalni uređaj / Εργαλείο πολλαπλών χρήσεων / Dispositivo multifunción / Dispositivo multifunzione / Dipositivo multifuncional / Appareil multifonction / multifunctioneel toestel

500W 230V- 50Hz
8000-16000 min⁻¹
5°

Ref.	[kg]	⊠	EAN
59G025	1,1	1/4	5902062087836

ENERGY+ system
NEO GRAPHITE
18V Li-Ion
5000-20000 min⁻¹
3°

Ref.	[kg]	⊠	EAN
58G013	1,8	1/4	5902062035417

Szlifierka mimośrodowa

Orbital sander / Excenter Schleifmaschine / Эксцентриковая шлифовальная машина / Шліфмашина ексцентрикова / Excentercsiszoló / Masina de slefuit excentrica / Excentrická bruska / Excentrická brúška / Ekscentrični brusilnik / Ekscentrinis šliuoklis / Ekscentra slīpmašīna / Ekscentriklihvija / Шлайфмашина ексцентрична / Vibracijska bušilica / Ekscentrična brusilica / Εκκεντρο τριβείο / Lijadora excéntrica / Levigatrice roto-orbitale / Disco de limar / Meuleuse excentrique / Excenter schuurmachine



Polerka

Polisher / Poliermaschine / Полировальная машина / Машина полирувальна / Polírozógép / Masina de lustrui / Leštička / Leštička / Polirka / Poliravimo staklės / Pūlēšanas mašīna / Poleerija / Машина за полиране / Апарат за poliranje / Polir mašina / Μηχανή σπλῶματος / Pulidora / Lucidatore / Aparelho polidor / Polisseuse / Polijstmachine



Szlifierka prosta akumulatorowa ENERGY+

Straight grinder / Schleifer gerade / Машина шлифовальная прямая / Машина шлифовальная прямая / Egyenes csiszológép / Polzor simplu / Přímá bruska / Priama brúška / Premi brusilnik / Tiesinis šliuoklis / Taisna slīpmašīna / Lihtlihvija / Шлайфмашина простая / Ravna brusilica / Obična brusilica / Τριβείο απλό / Lijadora recta / Smerigliatrice assiale / Lixadeira reta / Meule droite / Rechte slijper



Opalarka akumulatorowa ENERGY+

Cordless Heat Gun / Schnurlose Heißluftpistole / Аккумуляторная тепловая пушка / Аккумуляторная тепловая гармата / Akkus hólégfúvó / Arma de càldurà fàrà fir / Akumulátorová tepelná pistole / Akumulátorová tepelná pištol' / Brežični toplotni pištol / Akumulátorinis šilumos pistoletas / Bežvada karstuma pistole / Juhtmeta soojuspiistol / Безжичен топлинен пистолет / Bežični toplinski pištolj / Безжични топлинни пуштомъ / Πιστόλι θερμότητας χωρίς καλώδιο / Pistola de calor sin cuerda / Pistola termica a batteria / Pistola de calor sem fio / Pistolet à chaleur sans fil

ENERGY+
system

NEO GRAPHITE



18V
Li-Ion



200 l/min



550°C



Ref.	[kg]	⊠	EAN
58G082	0,6	1/5	5902062503497

Pistolet klejowy ENERGY+

Glue gun / Leimpistole / Пистолет клеєвий / Πιστοлет κλεϊσούϊ / Ragasztópisztoly / Pistol de lipit / Lepící pistole / Pištol lepiaca / Lepilna pištola / Klijy pistoletas / Limes pistole / Liimpüstol / Пистолет за силикон / Pištolj za plastiku / Pistolj za plastiku / Πιστόλι θερμοκόλλησης / Pistola surtidora de pegamento / Pistola incollante / Pistola p. cola / Pistolet à colle / Lijmpistol

ENERGY+
system

NEO GRAPHITE



18V
Li-Ion



Ø 11 mm



3 min



max 210°C



Ref.	[kg]	⊠	EAN
58G040	0,4	1/5	5907558480078

Opalarka

Hot air gun / Sengmaschine / Термофен / Фен / Hólégfúvó / Masina de parlit / Opalovací pistole / Opalovací pištol' / Fen / Techninis fenas / Celtnieciības fēns / Куурапуhur / Пистолет за зорещ въздух / Puhala vrućeg zraka / Fen / Πιστόλι θερμού αέρα / Decaparador por aire caliente / Pistola ad aria calda / Soprador de ar quente / Décapeur thermique / Verfstripper

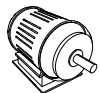

2000W



230V- 50Hz



I: 300 l/min
II: 150 l/min
III: 500 l/min



I: 25°C
II: 350°C
III: 550°C



Ref.	[kg]	⊠	EAN
59G522	1,9	0/5	5902062595225



2000W



230V- 50Hz



I: 350 l/min
II: 350 l/min
III: 500 l/min



I: 50°C
II: 50-550°C
III: 50-550°C



Ref.	[kg]	⊠	EAN
59G526	0,74	1/5	5902062086747



2000W



230V- 50Hz



I: 300 l/min
II: 500 l/min



I: 350°C
II: 550°C



Ref.	[kg]	⊠	EAN
59G523	1,0	1/10	5902062086730



2000W



230V- 50Hz



I: 300 l/min
II: 500 l/min



I: 50°C
II: 70-600°C



Ref.	[kg]	⊠	EAN
04-710	0,77	1/5	5907558470550

Wyrzynarka akumulatorowa ENERGY+

Jigsaw / лобзик / Masina de decupa / Szűrőfűrész / Seghetto alternativo / Scie sauteuse / Schweifsäge / Лобзик Кмитаци пила / Priamočiara píla / Ubodna píla / Siaurpiükli / Figürzägis / Vbodna žaga / Ажурна дървообработваща машина / Testera / Ξέγα / Tafeldecoupeerzaag / Máquina de entalhar / Sierra de calar Tikksaag

ENERGY+
system
NEO GRAPHITE

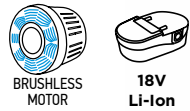

800- 3800 min⁻¹



Ref.	[kg]	⊠	EAN
58GE145	1,7	1/5	5902062091307

Latarka akumulatorowa ENERGY+

Cordless flashlight / Taschenlampe / Аккумуляторный фонарь / Лихтарик / Akkus lámpa / Lanterna / Bateria / Lampa / Svetilka / Žibintuvēlis / Lukturis / Pōleti / Фенерче / Baterijska lampa / Lampa / Φακός / Linterna de mano / Torcia / Lanterna / Torche / Zaklamp

ENERGY+
system
NEO GRAPHITE

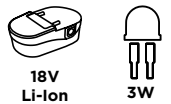

260 lm 7000 K

120°



Ref.	[kg]	⊠	EAN
58G007	0,3	1/10	5902062035356

Lampa akumulatorowa

Battery lamp / Аккумуляторна лампа / Lampă cu baterie / Akkumulátoros lámpa / Lampada a batteria / Lampe à piles / Akku-Lampe / Аккумуляторная лампа / Bateriová lamp / Batériová lamp / Puijiva lamp / Akumulātorious lempa / Akumulātorā lukturis / Baterijska svetilka / Лампа за батерию / Пуњива лампа / Λαμπτήρας μπαταρίας / Acculamp / Lámpada de bateria / Lámpara de batería / Akulamp



18V Li-Ion

2000/1000 LM



Ref.	⊠	EAN
58GE109	1/12	5902062082480

Pilarka szablowa akumulatorowa ENERGY+

Sabre saw / Motorstichsäge / Сабельная пила / Пилка шабельна / Szablyafűrész / Ferästräu sabie / Šavlová píla / Chvostová píla / Sabljasta žaga / Tiesinis pjūklas / Zobenzägis / Saabelsaag / Саблен трион / Sabljasta píla / Sabljasta testera / Σταθόσαγα / Sierra de vaivén / Segá universale / Serra de sabre / Scie à sabre / Sabelzaag

ENERGY+
system
NEO GRAPHITE

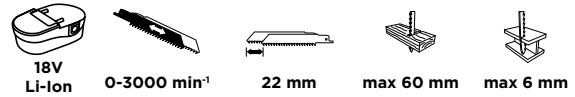

Ref.	[kg]	⊠	EAN
58G017	1,8	0/5	5902062035928

Pilarka szablowa

Sabre saw / Motorstichsäge / Сабельная пила / Пилка шабельна / Mini szűrőfűrész / Ferästräu sabie / Šavlová píla / Chvostová píla / Sabljasta žaga / Tiesinis pjūklas / Zobenzägis / Saabelsaag / Саблен трион / Sabljasta píla / Sabljasta testera / Σταθόσαγα / Sierra de vaivén / Mini sega a gattuccio / Serra de sabre / Scie à sabre / Sjabelzaag

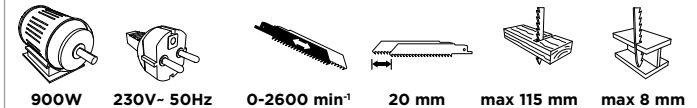

Ref.	[kg]	⊠	EAN
58G971	3,1	0/6	5902062015716

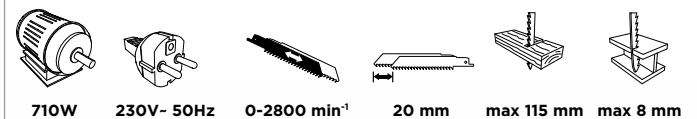

Ref.	[kg]	⊠	EAN
58G961	2,4	1/6	5902062103093

Stacja lutownicza

Soldering iron / LötKolben / Паяльник / Паяльник / Forrasztópáka / Fier de lipit / Pájeka / Spájkovačka / Spajkalnik / Lituoklis / Lodāturš / Паянник / Σίδερο συγκόλλησης / Soldador / Saldatore / Ferro de soldar / Fer à souder / Soldeerbout

ENERGY+
system

NEO GRAPHITE



18V
Li-Ion



150-480°C



Ref.	Ⓜ [kg]	📦	EAN
58GE143	0,34	1/24	5902062202949



Wyciskacz

Caulking gun / Auspresser / Пустолет для силикона / Пістолет до силикону / Kinyotápisztoly / Seringă etanșare sudură / Pistol na silikonové tuby / Pištol na silikoný / Silikonka pištola / Pistoletas sandarinimo priemonėms / Silikona spiedpistole / Τιμήμισπύστολ / Пустолет за силикон / Pištolj za silikon / Pistolj za silikon / Πιστόλι αλκόνης / Pistola para tubos de silicona / Spremitoio / Espremedor / Pistolet / Afdichtingspistool

ENERGY+
system

NEO GRAPHITE



18V
Li-Ion

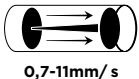

0,7-11mm/s

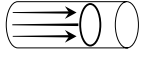

MAX FORCE: 4500N



Ref.	📦	EAN
58GE114	1/4	5902062082527

ENERGY+
system

NEO GRAPHITE



18V
Li-Ion

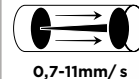

0,7-11mm/s

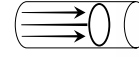

MAX FORCE: 4500N



Ref.	📦	EAN
58GE115	1/4	5902062082534

Radio akumulatorowo-sieciowe

Cordless-network radio / Бездротове радіо на батарейках / Radio acumulator-rețea / Akkumulátoros-hálózati rádió / Radio di rete ricaricabile / Radio secteur rechargeable / Akku-/Netz-Radio / Аккумуляторный сетевой радиоприемник / Dobijeci síťové rádio / Nabíjateľné sieťové rádio / Baterijski mrežni radio / Įkraunamas tinklo radijas / Uzlādējams tīkla radio / Radijski sprejemnik z možností polnjenja iz električnega omrežja / Аккумуляторно мрежово радио / Baterija-mrežni radio / Επαναφορτιζόμενο ραδιόφωνο δικτύου / Opladbare netradio / Rádio de rede recarregável / Radio de red recargable / Laetav võrguradio

ENERGY+
system

NEO GRAPHITE



18V
Li-Ion

Radio
Data
System

DAB+
FM
Bluetooth
USB

ALARM
CLOCK

5.0

DUAL
POWER



Ref.	📦	EAN
58GE128	1/2	5902062087959

Przecinarka do metalu

Portable cut-off saw / Metall-Trennmaschine / Пила по металлу / Пилка монтажна / Fémdaraboló / Aparat portabil de debitat în metale / Rezačka kovu / Rezačka na kov / Reznalnik kovine / Metalo pjūklas / Metāla griezējs / Metallisæpink / Сечач за метал / Rezalica za metal / Sekaç za metal / Πριόνι μετάλλου / Cortador para metal / Troncatrice per metallo / Cortador p. metal / Tronçonneuse à métal / Metaalknipper



2600W



230V- 50Hz



Ø 355/24,5 mm



3800 min⁻¹



max 120 mm



Ref.	Ⓜ [kg]	📦	EAN
59G873	19	0/1	5902062504890

Szlifierka stołowa

Bench grinder / Tischschleifmaschine / Машина шлифовальная настольная / Шліфмашина верстатна / Kőszögűgép / Masina de slefuit de banc / Stolní bruska / Stolová bruska / Namizni brusilnik / Stacionarus galgštavas / Galda slīpmašīna / Lauakki / Настольен абрихт / Stolna brusilica / Stona brusilica / Επιτραπέζιο τριβείο / Amoladora de banco / Smerigliatrice da banco / Disco de limar de mesa / Meuleuse d'établi / Tafelschuurmachine

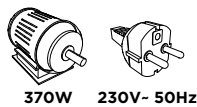

370W 230V- 50Hz



12,7/150 mm



2980 min⁻¹



Ref.	📦 [kg]	📦	EAN
59G383	11,1	0/1	5902062593832



Kompresor akumulatorowy

Inflator with accessories / Akku-Kompressor mit Zubehör / Компрессор аккумуляторный с оснасткой / Компресор аккумуляторный з принадлежностями / Légkompresszor tartozékokkal / Compresor de cumulator cu accesorii / Akumulátorový kompresor s príslušenstvom / Akumulátorový kompresor s príslušenstvom / Akumulatorski kompresor z opremo / Automobiliinis kompresorius su įranga / Akumulatora kompresors ar piederumiem / Akukompresor koos tarvikutega / Аккумуляторен компресор с оборудване / Akumulatorski kompresor s opremom / Συμπιεστής επαναφορτιζόμενος με βοηθητικά εξαρτήματα / Compresor a bateria con accesorios / Compresore a batteria con accessori / Compresor de ar para bateria com acessórios / Compresseur à batterie avec accessoires / Batterijcompressor met accessoires



18V Li-Ion



7 bar



Ref.	📦 [kg]	📦	EAN
58G041	0,8	1/5	5907558480085



18V Li-Ion



max 8 bar



4300 min⁻¹

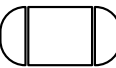

3.8 L



4300 min⁻¹



Ref.	📦 [kg]	📦	EAN
04-620	5,68	1/2	5907558495980

Uchwyt na akumulator Energy+

Energy+ battery holder / Energy+ Batteriehalter / Держатель аккумулятора Energy+ / Тримач аккумулятора Energy+ / Energy+ elemtartó / Suport baterie Energy+ / Držák baterie Energy+ / Držák baterie Energy+ / Nosilec baterije Energy+ / Energy+ akumulātorius laikiklis / Energy+ akumulātorius turētājs / Energy+ akuhojida / Държач за батерия Energy+ / Energy+ držač baterije / Енерџи+ дрџач батерије / Στήριγμα μπαταρίας Energy+ / Portapilas Energy+ / Portabatterie Energy+ / Suporte de bateria Energy+ / Support de batterie Energy+ / Energie+ batterijhouder



Ref.	📦	EAN
58G090	0/50	5902062493781

Adapter USB - latarka LED ENERGY+

USB adapter - LED flashlight / USB-adapter - LED-taschenlampe / Переходник USB - фонарик LED / Adapter USB — ліхтар LED / USB adapter - LED lámpa / Adaptor USB - lanternă LED / USB adaptér - LED svítilna / USB adaptér - LED baterka / Adapter USB - svetilka LED / Jungtis USB - žibintuvėlis LED / USB adapters - LED lukturis / USB-adapter - LED-taskulap / USB adapter - LED фенер / Adapter USB - LED svjetiljka / USB adapter - LED lamp / Φορτιστ φορηστής με USB και φακό LED / Adaptador USB - linterna LED / Adattatore USB - torcia elettrica LED / Adaptateur USB - torche LED / USB adapter - LED zaklamp



18V Li-Ion

USB out 5V DC 1,5A



1W



Ref.	📦 [kg]	📦	EAN
58G025	0,11	1/50	5907558480092

Akumulator systemu ENERGY+

Battery / Akumulator / Аккумуляторная батарея / Акумулятор / Akumulátor / Acumulator / Akumulátor / Akumulátor / Akumulator / Akumulatorius / Akumulators / Aku / Акумулятор / Akumulator / Akumulator / Ηλεκτρικός συσσωρευτής / Batería / Batterie / Bateria / Batterie / Accu



58G004-1



58G001-1



58G086-1



58GE152



Ref.	[Ah]	☒	EAN
58G001-1	2.0	0/20	5902062996756
58G004-1	4.0	0/10	5902062107350
58G086-1	6.0	0/20	5902062110077
58GE152	8.0	0/10	5902062595164

Zestaw Energy+: akumulator 4Ah z ładowarką

Energy+ set: 4Ah battery with charger / Energie+ Satz: 4Ah Akku mit Ladegerät / Комплект Energy+ аккумулятор 4Ah с зарядным устройством / Набор Energy+: Акумулятор 4Ah із зарядним пристроєм / Energy+ készlet: 4Ah akkumulátor töltővel / Setul Energy+: Baterie 4Ah cu încărcător / Sada Energy+: 4Ah baterie s nabíječkou / Súprava Energy+: 4Ah batéria s nabíjačkou / Komplet Energy+: 4Ah baterija s polnilnikom / Energy+ rinkings: 4Ah akumulatorius su įkrovikliu / Energy+ komplekts: 4Ah akumulators ar lādētāju / Energia+ komplet: 4Ah aku koos laadijaga / Комплект Energy+: Батерія 4Ah със зарядно устройство / Energy+ set: 4Ah baterija sa punjačem / Энерг+ сет: 4Ah батерія са пуньачем / Set Energy+: με φορτιστή / Set de energie+: Bateria de 4Ah con cargador / Set Energy+: Bateria da 4Ah con caricatore / Conjunto Energy+: Bateria 4Ah com carregador / Ensemble Energy+: Batterie 4Ah avec chargeur / Energy+ set: 4Ah batterij met lader



58GE132-1



58GE131-1



Ref.	[Ah]	☒	EAN
58GE131-1	2.0	0/10	5902062117304
58GE132-1	4.0	0/10	5902062117311



Ładowarka do akumulatorów ENERGY+

ENERGY+ battery charger / Akku-Ladegerät / Зарядное устройство системы ENERGY+ / Зарядний пристрій для акумуляторів / Töltő / Încarcator pentru acumuloare / Nabíječka baterii / Nabíjačka akumulátora / Polnilnik za akumulatorje / Akumulatorių įkroviklis / Akumulatoru lādētājs / Akulaadija / Зарядно устройство за акумулаторите / Punjač za akumulator / Punjač za akumulator / Φορτιστής / Cargadora para baterías / Carica batterie / Carregador de baterias / Chargeur à batteries / Accuoplader



NEO GRAPHITE TOOLS



58G002-1



58G085-1



Ref.	☒	EAN
58G002-1	0/10	5902062996732
58G085-1	0/10	5902062996749

Torba na elektronarzędzia ENERGY+

Power tool bag / Werkzeugtasche / Сумка для электроинструмента / Торба інструментальна / Gépartat táská / Geanta scule / Brašna na nářadí / Taška na montérská / Torba za orodje / Krepšys įrankiams / Instrumentu soma / Tööriistakott / Чанта за инструменти / Torba za alat / Torba za alat / Σάκος για εργαλεία / Bolsa para herramientas / Borsa in tela / Saco p. ferramentas / Sac à outils / Gereedschapstas

18,5L Poliester

18.5 l,
46x24x45 cm



Ref.	[kg]	☒	EAN
58G092	1.7	0/4	5902062506801

18,5L Poliester

18.5 l,
48x24x44,5 cm



Ref.	[kg]	☒	EAN
58G093	4.9	0/2	5902062506818

AKCESORIA DO ELEKTRONARZĘDZI

power tools accessories електроінструменти аксесуари



Wiertła do metalu

HSS drills / Metallbohrer / Сверла по металлу / Сверла по металу / Csigafúró / Burghie pentru metale / Vrtáky do kovu / Vrtáky do kovu / Svedri za kovino / Grąztaï metalui / Urbis metaläm / Metallpuur / Сврла за метал / Svrdla za metal / Burgija za metal / Τρυπάνια μετάλλου / Brocas para metal / Punta per metallo / Brocas p. metal / Forêts à métal / Boren voor metaal

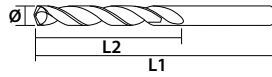

Ref.	Ø [mm]	L1 [mm]	L2 [mm]	📦	📦	EAN
55-010	2.0	46	24	125/500	5906692002597	
55-013	2.5	57	30	125/500	5906692002603	
55-014	3.0	61	33	125/500	5906692002610	
55-015	3.2	65	36	125/500	5906692002627	
55-016	3.5	70	39	125/500	5906692002634	
55-017	3.8	75	43	125/500	5906692002641	
55-018	4.0	75	43	125/500	5906692002658	
55-019	4.2	75	43	120/480	5906692002665	
55-020	4.5	80	47	120/480	5906692002672	
55-021	4.8	86	52	120/480	5906692002689	
55-022	5.0	86	52	120/480	5906692002696	
55-024	5.5	93	57	120/480	5906692002702	
55-025	6.0	93	57	120/480	5906692002719	
55-026	6.5	101	63	120/480	5906692002726	
55-027	7.0	109	69	75/300	5906692002733	
55-029	8.0	117	75	75/300	5906692002740	
55-030	8.5	117	75	75/300	5906692002757	
55-031	9.0	125	81	75/300	5906692002764	
55-033	10.0	133	87	50/200	5906692002771	
55-035	10.5	133	87	50/200	5906692002788	
55-036	11.0	142	94	50/200	5906692002795	
55-038	12.0	151	101	50/200	5906692002801	
55-039	12.5	151	101	45/180	5906692002818	
55-040	13.0	151	101	45/180	5906692002825	

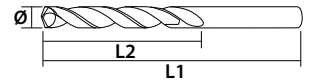

Ref.	Ø [mm]	L1 [mm]	L2 [mm]	📦	📦	EAN
57-010	1.0	34	12	5	0/200	5906692008407
57-012	1.5	40	18	5	0/200	5906692008414
57-014	2.0	49	24	5	0/200	5906692008421
57-014-10	2.0	49	24	10	0/400	5906692008438
57-015	2.2	53	27	3	0/200	5906692008445
57-016	2.4	57	30	3	0/200	5906692008452
57-018	2.5	57	30	3	0/200	5906692008469
57-018-10	2.5	57	30	10	0/400	5906692008476
57-020	3.0	61	33	1	0/200	5906692008483
57-020-10	3.0	61	33	10	0/200	5906692008490
57-022	3.2	65	36	1	0/200	5906692008506
57-022-10	3.2	65	36	10	0/200	5906692008513
57-023	3.5	70	39	1	0/200	5906692008520
57-023-10	3.5	70	39	10	0/200	5906692008537
57-024	4.0	75	43	1	0/200	5906692008544
57-024-10	4.0	75	43	10	0/200	5906692008551
57-026	4.2	75	43	1	0/200	5906692008568
57-026-10	4.2	75	43	10	0/200	5906692008575
57-028	4.5	80	47	1	0/200	5906692008582
57-028-10	4.5	80	47	10	0/100	5906692008599
57-030	4.8	86	52	1	0/200	5906692008728
57-030-10	4.8	86	52	10	0/100	5906692008735
57-032	5.0	86	52	1	0/200	5906692008742
57-032-10	5.0	86	52	10	0/100	5906692008759
57-034	5.2	86	52	1	0/200	5906692008766
57-034-10	5.2	86	52	10	0/100	5906692008773
57-036	5.5	93	57	1	0/200	5906692008780
57-036-10	5.5	93	57	10	0/100	5906692008797
57-038	6.0	93	57	1	0/200	5906692008803
57-038-10	6.0	93	57	10	0/100	5906692008810
57-040	6.5	101	63	1	0/200	5906692008827
57-040-10	6.5	101	63	10	0/40	5906692008834
57-042	7.0	109	69	1	0/200	5906692008841
57-042-10	7.0	109	69	10	0/40	5906692008858
57-044	7.5	109	69	1	0/200	5906692008865
57-046	8.0	117	75	1	0/200	5906692008872
57-046-5	8.0	117	75	5	0/40	5906692008889
57-048	8.5	117	75	1	0/200	5906692008896
57-048-5	8.5	117	75	5	0/40	5906692008902
57-050	9.0	125	81	1	0/200	5906692008919
57-050-5	9.0	125	81	5	0/40	5906692008926
57-052	9.5	125	81	1	0/200	5906692008933
57-054	10.0	133	87	1	0/200	5906692008940
57-054-5	10.0	133	87	5	0/40	5906692008957
57-055	10.2	133	87	1	0/200	5906692008964
57-056	10.5	133	87	1	0/200	5906692008971
57-056-5	10.5	133	87	5	0/40	5906692008988
57-058	11.0	142	94	1	0/200	5906692008995
57-058-5	11.0	142	94	5	0/40	5906692009008
57-062	12.0	151	101	1	0/200	5906692009015
57-062-5	12.0	151	101	5	0/40	5906692009022
57-064	12.5	151	101	1	0/120	5906692009039
57-066	13.0	151	101	1	0/120	5906692009046
57-066-5	13.0	151	101	5	0/40	5906692009053



Ref.	Ø [mm]	📦	📦	EAN
57-086	4 / 5 / 6 / 8 / 10	5	0/100	5906692009060
57-088	1.5 / 2.0 / 2.5 / 3.0 / 3.2 / 3.5 / 4.0 / 4.2 / 4.8 / 5.0 / 5.5 / 6.0 / 6.5	13	0/100	5906692009077
57-089	1.0 / 1.5 / 2.0 / 2.5 / 3.0 / 3.5 / 4.0 / 4.5 / 5.0 / 5.5 / 6.0 / 6.5 / 7.0 / 7.5 / 8.0 / 8.5 / 9.0 / 9.5 / 10.0	19	0/40	5906692009084
57-090	1.0 / 1.5 / 2.0 / 2.5 / 3.0 / 3.5 / 4.0 / 4.5 / 5.0 / 5.5 / 6.0 / 6.5 / 7.0 / 7.5 / 8.0 / 8.5 / 9.0 / 9.5 / 10.0 / 10.5 / 11.0 / 11.5 / 12.0 / 12.5 / 13.0	25	0/10	5906692009091

Wiertło bezstopniowe

Stepless Conical Bit / Stufenloser Bohrer / Сверло коническое / Сверло коничне / Fokozatmentes fúró / Burghiu nelárgitor / Kuželový vrták / Kuželový vrták / Stožčasti sveder / Konusinis gražtas / Koniskais urbis / Koopusruur / Конично саредло / Konusno svrdlo / Glatka burgija / Τρυπάνι με κωνικό στέλεχος / Broca sin grados / Punta conica / Broca sem graus / Foret non étagé / Traploze boor



METAL
HSS

Ref.	ø [mm]	⊠	EAN
57-741	4-32	10/50	5906692012114

Wiertło stopniowe

Stepped Conical Bit / Stufenbohrer / Сверло ступенчатое / Сверло ступеневе / Lépcsős fúrószár / Burghiu lărgitor conic / Stupňovitý vrták / Stupňovitý vrták / Stopenjski sveder / Pakorinis gražtas / Pakārņveida urbis / Astmeline puur / Многоствъпално саредло / Stepenasto svrdlo / Konusna - stepenasta burgija / Τρυπάνι διάνοιξης οπών με διαβάθμιση / Broca con grados / Punta conica / Broca de graus / Foret étagé / Trapboor



METAL
HSS

Ref.	ø [mm]	⊠	EAN
57-739	4-22	10/50	5906692012091
57-740	4-32	10/50	5906692012107

Tarcza tnąca

Cutting disc / Schneidescheibe / Диск пильный / Диск ризальний / Vágókorong / Disc tăietor / Pilový kotouč / Pilový kotúč / Rezilna plošča / Pjovimo diskas / Zăga disks / Lōikeketas / Режущий диск / Rezna ploča / Ploče za sečenje / Διακος κοπής / Disco de corte / Disco da taglio per metallo / Disco cortante / Disque de coupage / Snijshijven



Ref.	Ø1 [mm]	Ø2 [mm]	W1 [mm]	info	info	⊠	EAN
55-570	115	22.2	1.0	41 A60-R-BF	INOX (Fe+S+Cl<0,1%)	0/40	5906692004010
55-572	125	22.2	1.0	41 A60-R-BF	INOX (Fe+S+Cl<0,1%)	0/40	5906692004027



Ref.	Ø1 [mm]	Ø2 [mm]	W1 [mm]	info	⊠	EAN
55-574	115	22.2	1.0	41 A60-R-BF	0/40	5906692004034
55-576	125	22.2	1.0	41 A60-R-BF	0/40	5906692004041



Ref.	ø1 [mm]	ø2 [mm]	W [mm]	Info	⊠	EAN
57-700	125	22.2	1.6	41 A46-R-BF	100/400	5906692011902
57-705	115	22.2	1.0	41 A60-R-BF	100/400	5906692011919
57-719	230	22.2	1.9	41 A36-R-BF	50/100	5906692012022



Ref.	Ø1 [mm]	Ø2 [mm]	W1 [mm]	info	⊠	⊠	EAN
08-720	125	22.2	1.0	41 A60-S-BF	25	0/1	5907558430356
08-722	125	22.2	1.0	41 A60-S-BF	100	0/1	5907558472363
08-721	230	22.2	1.9	41 A60-S-BF	25	0/1	5907558430370



Ref.	Ø1 [mm]	Ø2 [mm]	W1 [mm]	info	⊠	⊠	EAN
55-577	115	22.2	1.0	41 A60-T-BF	10	0/40	5906692004058
55-578	125	22.2	1.0	41 A60-T-BF	10	0/40	5906692004065
55-579	230	22.2	1.9	41 A46-S-BF	5	0/20	5906692004072

Nakrętka szybkocomująca

Quick-action nut / Schnellspannende Mutter / Быстрозажимная гайка / Швидкозатискна гайка / Gyorszáras anya / Piułiță cu acțiune rapidă / Rychloupínací matice / Rýchloupínacia matica / Hitro delujoča matica / Greito veikimo veržlė / Átrās darbības uzgrieznis / Pikamutter / Γαΐνα с бързо действие / Παζμóδι ταχείας δράσης / Brza matica / Накрѣтка са брзим дејством / Tuercas de acción rápida / Dado ad azione rapida / Porca de acção rápida / Ecrou à action rapide



Ref.	⊠	EAN
56-421	5/100	5906692007042

Otwornica

Compass saw / Lochsäge / Ножовка / Фреза / Lyukfűrész / Ferástráiu pentru găuri / Dërovka / Dierovacica pila / Luknjarica / Vienarankis pjūkļas / Rokzāģis / Augusaag / Тесен тпуон / Nareznica / Ručna testera za pravljenje otvora / Πριόνι / Sierra de corona / Seg a tazza a doppio metallo / Serra para recorte / Scie à guichet / Gatenknipper

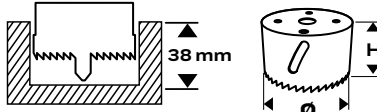
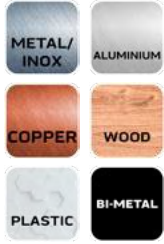

Ref.	ø [mm]	H [mm]	☒	EAN
57-900	16	56	0/96	5906692012909
57-902	19	50	0/96	5906692012923
57-904	20	50	0/96	5906692012947
57-901	21	50	0/96	5906692012916
57-906	22	50	0/96	5906692012961
57-908	25	50	0/96	5906692012985
57-903	27	50	0/72	5906692012930
57-910	29	50	0/72	5906692013005
57-912	32	50	0/72	5906692013029
57-914	35	50	0/72	5906692013043
57-916	38	44	0/72	5906692013067
57-918	40	44	0/72	5906692013081
57-905	44	44	0/72	5906692012954
57-920	46	44	0/72	5906692013104
57-922	51	44	0/72	5906692013128
57-907	54	44	0/72	5906692012978
57-924	57	44	0/72	5906692013142
57-909	60	44	0/24	5906692012992
57-926	64	44	0/24	5906692013159
57-928	67	44	0/24	5906692013166
57-911	70	44	0/24	5906692013012
57-930	73	44	0/24	5906692013173
57-932	83	44	0/24	5906692013180
57-913	86	44	0/24	5906692013036
57-915	92	44	0/24	5906692013050
57-934	95	44	0/24	5906692013197
57-936	105	44	0/24	5906692013203
57-917	114	44	0/24	5906692013074
57-919	140	44	0/24	5906692013098

Adapter do otwornic

Adaptor for hollow annular drill heads / Adapter für Lochsäge / Переходник для коронки / Адаптер переходний до фрез / Adapter lyukfűrészhez / Adaptor pentru capete găurire cu coroana / Adaptér pro děrovky / Adaptér do dierovacich pil / Adapter za luknjarice / Jungtis grežimo karūnai / Adapteris kroonpuuridele / Адаптер за сєредна / Adapter za nareznice / Adapter za ručne testere / Ανάτορας για ποτρωτρήσιμα / Adaptador para sierras de corona / Adattatore per sega a tazza / Adaptador do Serras para recorte / Adaptateur de scie à guichet / Adapter voor gatenknippers



Ref.	Ø [mm]	Info	☒	EAN
57-938	14-30	adapter	0/50	5906692013210
57-940	>30	adapter	0/50	5906692013227
57-944	6,35	wiertło	0/50	5906692013234

Wiertła-pily

Saw drills / Bohrer - Säge / Сєєрна-пилы / Сєєрдла-фрезу / Marófűrő készlet / Burghie - ferástráiu / Vrtáky / Pily / Frézovací vrták / Svedri-žage / Gražtai - pjūkļai / Urbji-zági / Puurid-saed / Сєєрдла-тпуону / Svrđla pile / Burgije-testere / Πριωνάτá труνάvia / Brocas sierras / Set punta seghettata / Foréts-scies / Boorzagen

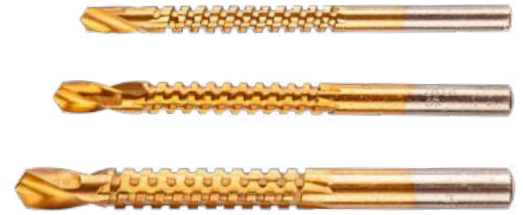

Ref.	ø [mm]	☒	EAN
57-250	5, 6, 8	50/100	5906692009633

Fazownik

Beveller / Kegelsenker / Фаска / Фаска / Κύρος έλιετόρ / Frezä de şanfrenare / Dërovka / Vyhlbovacia fréza / Robilnik / Freza grioveliams / Fāzes uzgālis / Servaja / Уред за фаску / Glodalo za skošenje / Uredaj za zakošenje / Φρεζοτρήσιμο / Biselador / Smussatore / Chanfrador / Outil de fraisage / Afschuinapparaat

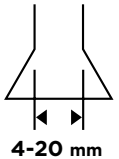

Ref.	ø [mm]	☒	EAN
56-246	4-20	10/100	5906692006946

Adapter

Adaptor / Adapter / Адаптер / Перехідник / Közdarab, adaptor / Adaptor / Adaptér / Adaptér / Adapter / Jungtis / Adapteris / Adapter / Адаптер / Adapter / Adapter / Ανάτορας / Adaptador / Adattatore / Adaptador / Adaptateur / Adapter

M14 ▶ HEX

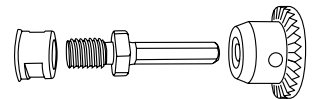

Ref.	☒	EAN
55-320	15/300	5906692003532

Frez z węglika spiekanego

Carbide rotary burr / Hartmetall-Drehgrat / Твердосплавная фреза / Твердосплавная фреза / Keresztfogazás / Freza din carbura de tungsten / Tvrdokovová rotační fréza / Fréza z tvrdokovu / Reznik iz volframovega karbida / Volframo karbido freza / Volframo karbida fréze / Frees / Фреза / Frezer / Glodalo / Фрѐза / Broca fresadora / Fresa / Fresa / Fraise / Frees

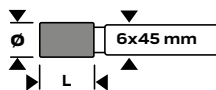

Ref.	ø [mm]	L [mm]	⊠	EAN
55-350	6	16	10/100	5906692003662
55-351	8	20	10/100	5906692003679
55-352	10	25	10/100	5906692003686
55-353	12	25	10/100	5906692003693
55-354	14	25	10/100	5906692003709
55-355	16	25	10/100	5906692003716

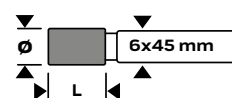
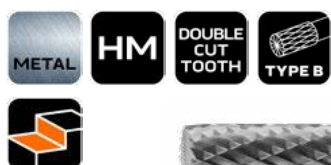

Ref.	ø [mm]	L [mm]	⊠	EAN
55-356	8	20	10/100	5906692003723
55-357	10	25	10/100	5906692003730
55-358	12	25	10/100	5906692003747
55-359	16	25	10/100	5906692003754

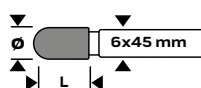

Ref.	ø [mm]	L [mm]	⊠	EAN
55-360	10	20	10/100	5906692003761
55-361	12	25	10/100	5906692003778

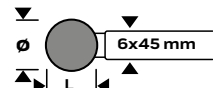

Ref.	ø [mm]	L [mm]	⊠	EAN
55-362	10	12	10/100	5906692003785

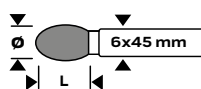

Ref.	ø [mm]	L [mm]	⊠	EAN
55-363	6	10	10/100	5906692003792
55-364	8	13	10/100	5906692003808
55-365	10	16	10/100	5906692003815
55-366	12	20	10/100	5906692003822
55-367	14	22	10/100	5906692003839
55-368	16	25	10/100	5906692003846

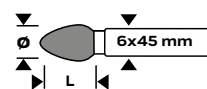

Ref.	ø [mm]	L [mm]	⊠	EAN
55-369	6	18	10/100	5906692003853
55-370	8	18	10/100	5906692003860
55-371	10	20	10/100	5906692003877
55-372	12	25	10/100	5906692003884
55-373	14	25	10/100	5906692003891
55-374	16	25	10/100	5906692003907

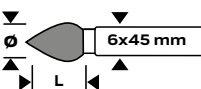

Ref.	ø [mm]	L [mm]	⊠	EAN
55-375	12	25	10/100	5906692003914

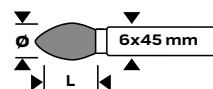

Ref.	ø [mm]	L [mm]	⊠	EAN
55-376	12	32	10/100	5906692003921

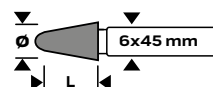
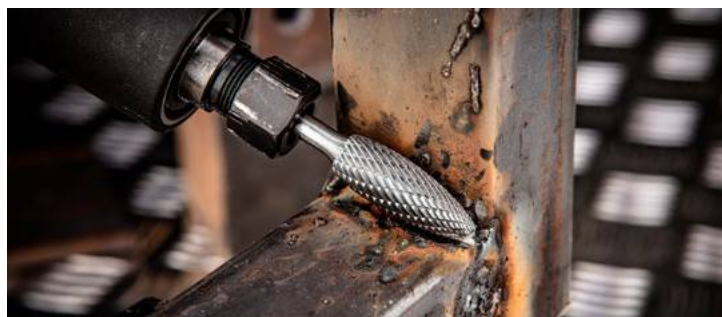

Ref.	ø [mm]	L [mm]	⊠	EAN
55-377	12	30	10/100	5906692003938

Tarcza szlifierska z rzepem

Rubber disc / Schleifscheibe mit Klettverschluss / Круг шлифовальный с липучкой / Круг шлифовальный на липучку / Rugalmas csiszolóanyag / Disc de cauciuc / Leštici kotouč se suchým zipem / Gumový disk stopkový pevný / Brusilna plošča z velcro papirjem / Guminis šlifavimo diskas / Gumijas pamatne slīpdiskam / Kummiketas / Диск зумен / Disk gumeni za bušilicu / Gumeni disk / Διακοκ λείανσης / Disco elástico con velcro / Disco di gomma / Disco p. esmerilhar / Meule abrasive à adhésif Velcro / Slijpschijf met velcroband



Ref.	Ø [mm]	⊠	EAN
55-928	125	10/40	5906692005659
55-929	150	5/40	5906692005666



Ref.	Ø [mm]	⊠	EAN
55-825	125	10/40	5906692004928
55-826	150	5/40	5906692004935



Ref.	Ø [mm]	⊠	EAN
55-823	125	5/40	5906692004904

Włóknina ścierna

Abrasive cloth / Schleifstoff / Наждачное волокно / Волокно абразивне / Csiszolófilc / Tesáturá abrazívá / Brusné rouno / Brúсна włókna / Brusno vlakno / Šlifavimo medžiaga / Slīpēšanas audekls / Lihvkviud / Абразивна тъкан / Brusna tkanina / Abraziva tkanina / Υφασμα λείανσης / Tela de lijar / Tessuto abrasivo / Tecido abrasivo / Textile abrasif / Papieren zak

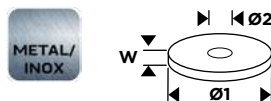

Ref.	Ø1 [mm]	Ø2 [mm]	W [mm]	⊠	EAN
55-992	125	22.2	15	0/200	5906692006014

Tarcza do usuwania kleju

Glue remover disc / Диск для удаления клея / Disc de îndepărtare a lipiciului / Ragasztó eltávolító korong / Disco rimuovi colla / Disque dissolvant de colle / Leimentfernerscheibe / Диск для удаления клея / Odstraňovač lepidla / Kotúč na odstraňovanie lepidla / Disk za uklanjanje ljeplila / Ključ šalinimo diskas / Limes noņēšanas disks / Disk za odstranjevanje lepila / Диск за отстраняване на лепило / Диск за уклањање лепка / Δίσκος αφαίρεσης κόλλας / Lijmverwijderaar / Disco de remoção de cola / Disco despegador / Liimi eemaldamise ketas



Ref.	Ø [mm]	⊠	EAN
55-811	88	0/50	5906692004850

Кръзкі ścierne

Abrasive discs / Schleifscheibe / Шлифовальные круги / Кругу шлифовальни / Csiszolókorongok / Discuri abrazive / Brusné kroužky / Brúсне kotúče / Brusne plošče / Šlifavimo diskeliiai / Slīpēšanas aplī / Lihvrõngad / Абразивни дискове / Brusni kolutiči / Diskovi za brušenje / Διακοκ λείανσης / Hoja de lija circular / Dischi abrasivi / Discos abrasivos / Roulette abrasive / Schuurwielen

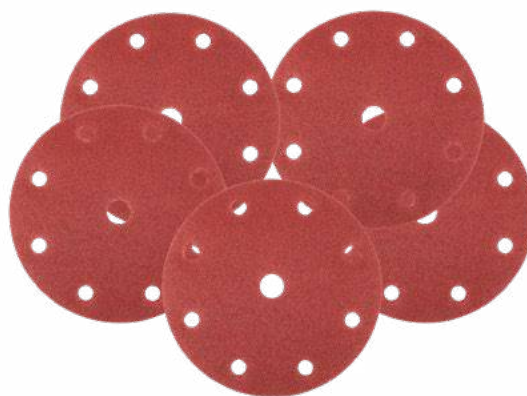

Ref.	Info	Ø [mm]	⊠	EAN
08-990	P40	150	0/100	5907558475845
08-991	P60	150	0/100	5907558475852
08-992	P80	150	0/100	5907558475869
08-993	P100	150	0/100	5907558475876
08-994	P120	150	0/100	5907558475883
08-995	P180	150	0/100	5907558475890
08-996	P240	150	0/100	5907558475906

Kražki ścierne

Abrasive discs / Schleifscheibe / Шлифовальные круги / Круги шлифовальные / Csiszolókorongok / Discuri abrazive / Brusné kroužky / Brúsné kotúče / Brusne plošče / Šlifavimo diskeltai / Slīpēšanas aplī / Lihvrõngad / Абразивни дискове / Brusni kolutiči / Diskovi za brušenje / Δίσκοι λείανσης / Hoja de lija circular / Dischi abrasivi / Discos abrasivos / Roulette abrasive / Schuurwielen



Ref.	Info	Ø [mm]			EAN
55-933	P40	125	5	0/200	5906692005703
55-934	P60	125	5	0/200	5906692005710
55-935	P80	125	5	0/200	5906692005727
55-936	P100	125	5	0/200	5906692005734
55-937	P120	125	5	0/200	5906692005741
55-938	P240	125	5	0/200	5906692005758



Ref.	Info	Ø [mm]			EAN
55-939	P40	125	5	0/200	5906692005765
55-940	P60	125	5	0/200	5906692005772
55-941	P80	125	5	0/200	5906692005789
55-942	P100	125	5	0/200	5906692005796
55-943	P120	125	5	0/200	5906692005802
55-944	P240	125	5	0/200	5906692005819

Ściernica listkowa

Flap wheel / Blatt-Schleifscheibe / Листовой шлифовальный круг / Круг шлифовальный листковый / Lamellás csiszoló / Disc de rectificat / Brusný kotouč listkový / Brúsný lamelový tanier / Brus z lističi / Šlifavimo lapelii / Lokšņu slīpēšanas riņķis / Lamell-lihvketas / Ламелен диск / Lepezasta brusna ploča / Kolut za brušenje / Τροχός λείανσης με πτερύγια / Abanico lijador / Spazzola lamellare / Disco abrasivo de folhas / Meule abrasive à lamelles / Schuurblad



Ref.	Info	Ø [mm]		EAN
57-835	P40	115 x 22.2	0/100	5906692012404
57-836	P60	115 x 22.2	0/100	5906692012411
57-837	P80	115 x 22.2	0/100	5906692012428
57-838	P100	115 x 22.2	0/100	5906692012459
57-839	P120	115 x 22.2	0/100	5906692012435
57-840	P36	125 x 22.2	0/100	5906692012442
57-841	P40	125 x 22.2	0/100	5906692012466
57-842	P60	125 x 22.2	0/100	5906692012473
57-843	P80	125 x 22.2	0/100	5906692012480
57-844	P100	125 x 22.2	0/100	5906692012497
57-845	P120	125 x 22.2	0/100	5906692012503



Ref.	Info	Ø [mm]		EAN
55-980	P36	115 x 22.2	0/100	5906692005895
55-981	P40	115 x 22.2	0/100	5906692005901
55-982	P60	115 x 22.2	0/100	5906692005918
55-983	P80	115 x 22.2	0/100	5906692005925
55-984	P100	115 x 22.2	0/100	5906692005932
55-985	P120	115 x 22.2	0/100	5906692005949
55-986	P36	125 x 22.2	0/100	5906692005956
55-987	P40	125 x 22.2	0/100	5906692005963
55-988	P60	125 x 22.2	0/100	5906692005970
55-989	P80	125 x 22.2	0/100	5906692005977
55-990	P100	125 x 22.2	0/100	5906692005984
55-991	P120	125 x 22.2	0/100	5906692006007

Kražki ścierne fibra

Abrasive fibre discs / Fiberschleifscheiben / Шлифовальные фибровые круги / Круги абразивні фібры / Csiszoló korongok fibra / Discuri abrazive fibre / Brusné kotouče fibr / Vlákničné brúsné kotúče / Brusni diski fibra / Abraziviniai šlifavimo diskai / Slīpēšanas šķiedradiski / Kiud-abrasivkettad / Абразивни фибър дискове / Fiber brusni diskovi / Brusni fiber disk / Ινώδες δίσκοι λείανσης / Discos de fibra / Dischi abrasivi in fibra / Discos abrasivos fibra / Disques abrasifs à fibres / Schuurshijven fiber



Ref.	Info	Ø [mm]			EAN
55-855	P40	125	3	0/100	5906692004959
55-856	P60	125	3	0/100	5906692004966
55-857	P80	125	3	0/100	5906692004973
55-858	P100	125	3	0/100	5906692004980
55-859	P120	125	3	0/100	5906692004997

Tarcza do fibry

Backing pad for fibre discs / Schleifteller für Fiberscheiben / Диск для фибры / Диск до фібры / Fibertárcsa / Disc pentru fibră / Kotouč na fibr / Kotuč na vlákno / Podložna plošča / Pluošto diskai / Disks fibrai / Fibriketas / Фибер диск / Ploča za fibr / Fiber disk / Πέλμα δίσκων από ινώδες υλικό / Disco para fibra / Disco di fibra / Disco para fibra / Disque fibre / Schijf voor fibra



Ref.	Ø [mm]		EAN
57-860	125	0/100	5906692012602

Ściernica trzpieniowa, listkowa

Sanding label cylinder / Blattschleifstift / Крыл шлифовальный лепестковый / Крыл образивний лепюстковий / Csapos csiszolókorong / Cilindru de șlefuit / Brusný kotouč listkový s trnem / Brusný kotouč listkový so stopkou / Lamelni brus / Šlifavimo padas / Stiplaru disks / Lihvilinder / Шкурка вентуро / Lamelni brus sa osovinom / Lamelni brus sa osovinom / Λειαντικός κύλινδρος / Mola a mandrino, fogli / Roda de esmeril / Meule abrasive à tige, à lamelles / Blad zandsteen

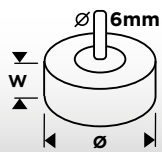

Ref.	info	Ø [mm]	W [mm]	⊠	EAN
55-754	P40	40	20	0/150	5906692004577
55-755	P60	40	20	0/150	5906692004584
55-756	P80	40	20	0/150	5906692004591
55-757	P40	60	30	0/100	5906692004607
55-758	P60	60	30	0/80	5906692004614
55-759	P80	60	30	0/100	5906692004621

Szczotka druciana

Wire brush / Drahtbürste / Щетка проволочная / Щітка по металу / Fazékkefe sodrott / Perie metal / Drátěný kartáč / Keļa drātenā univerzāla / Žična krtača / Vielinis šepetys / Drāšu birste / Traathari / Четка мелена / Četka sa PVC drškom / Cetka / Συρμάτινη βούρτσα / Cepillo de alambre / Spazzola a tazza / Escova de arame / Brosse métallique / Draadborstel

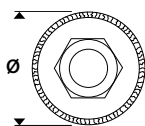

Ref.	Ø1 [mm]	⊠	EAN
57-581	65	10/80	5906692011278
57-582	80	10/80	5906692011285
57-583	100	10/40	5906692011292

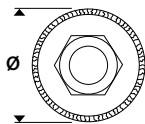

Ref.	Ø1 [mm]	⊠	EAN
57-585	65	6/36	5906692011308
57-587	100	6/24	5906692011315

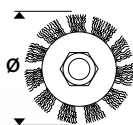

Ref.	Ø1 [mm]	⊠	EAN
57-589	100	6/72	5906692011322
57-591	115	8/48	5906692011339

Szczotka druciana

Wire brush / Drahtbürste / Щетка проволочная / Щітка по металу / Fazékkefe sodrott / Perie metal / Drátěný kartáč / Keļa drātenā univerzāla / Žična krtača / Vielinis šepetys / Drāšu birste / Traathari / Четка мелена / Četka sa PVC drškom / Cetka / Συρμάτινη βούρτσα / Cepillo de alambre / Spazzola a tazza / Escova de arame / Brosse métallique / Draadborstel

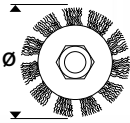

Ref.	Ø1 [mm]	⊠	EAN
57-596	115	6/60	5906692011353
57-598	125	5/50	5906692011360

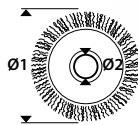

Ref.	Ø1 [mm]	Ø2 [mm]	⊠	EAN
57-592	125	20	10/60	5906692011346

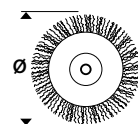

Ref.	Ø [mm]	⊠	EAN
57-599	50	12/144	5906692011377
57-600	75	10/120	5906692011384

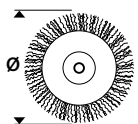

Ref.	Ø [mm]	⊠	EAN
57-601	50	20/240	5906692011391
57-602	75	12/144	5906692011407

Papier ścierny

Sanding paper / Schleifpapier / Бумага наждачная / Папір наждачний / Csiszolópapír / Hírtie smirghel ce se încheie singură / Brusný papír / Papier brúsný-rolka / Brusni papir / Šljafimo papirius / Smilšpapīrs / Liivapaber / Шкурка руло / Brusni papir u roli / Brusni papir / Λειαντικό ύφασμα / Lija / Carta abrasiva / Folha de lixa / Papier abrasif / Schuurpapier



Ref.	Info	W [mm]	☒	EAN
55-904	P320	280 x 230	0/1000	5906692005413
55-905	P600	280 x 230	0/1000	5906692005420
55-906	P800	280 x 230	0/1000	5906692005437
55-907	P1000	280 x 230	0/1000	5906692005444
55-908	P1200	280 x 230	0/1000	5906692005451
55-909	P1500	280 x 230	0/1000	5906692005468
55-910	P2000	280 x 230	0/1000	5906692005475
55-911	P2500	280 x 230	0/1000	5906692005482



Ref.	Info	W [mm]	☒	☒	EAN
55-763	P40	93 x 93 x 93	5	0/200	5906692004669
55-764	P60	93 x 93 x 93	5	0/200	5906692004676
55-765	P80	93 x 93 x 93	5	0/200	5906692004683
55-766	P100	93 x 93 x 93	5	0/200	5906692004690
55-767	P120	93 x 93 x 93	5	0/200	5906692004706
55-768	P240	93 x 93 x 93	5	0/200	5906692004713

Gąbka ścierna

Abrasive sponge / Scheuerschwamm / Абразивная губка / Губка наждачна / Csiszolószivacs / Burete abraziv / Brusná houba / Brúсна špongia / Brusna góbica / Abrazivine kempinė / Slīpēšanas sūklis / Lihvimiskāsn / Абразивна гъба / Brusna spružva / Abrazivni sunder / Λειαντικό αφουγγάρι / Esponja abrasiva / Spugna abrasiva / Esponja abrasiva / Éponge abrasive / Schurende spons /



Ref.	Info	W [mm]	☒	EAN
55-914	P180	120 x 95 x 10 mm	0/250	5906692005512

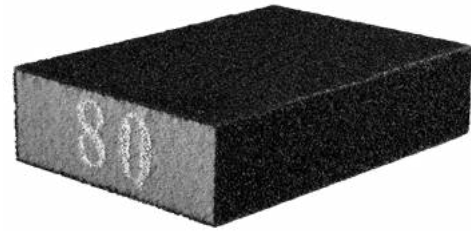

Ref.	Info	W [mm]	☒	EAN
55-915	P60	100 x 70 x 25	0/250	5906692005529
55-916	P80	100 x 70 x 25	0/250	5906692005536
55-917	P100	100 x 70 x 25	0/250	5906692005543
55-918	P120	100 x 70 x 25	0/250	5906692005550
55-919	P150	100 x 70 x 25	0/250	5906692005567
55-920	P180	100 x 70 x 25	0/250	5906692005574
55-921	P240	100 x 70 x 25	0/250	5906692005581

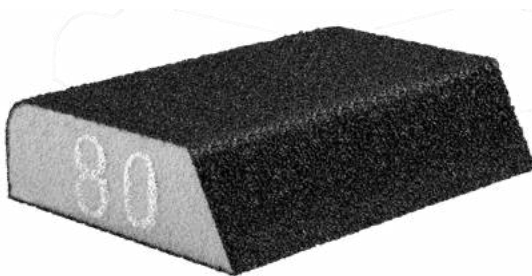

Ref.	Info	W [mm]	☒	EAN
55-925	P80	98 x 68 x 25	0/200	5906692005628
55-926	P120	98 x 68 x 25	0/200	5906692005635
55-927	P180	98 x 68 x 25	0/200	5906692005642



Ref.	Info	W [mm]	☒	EAN
55-922	P80	125 x 90 x 25	0/200	5906692005598
55-923	P120	125 x 90 x 25	0/200	5906692005604
55-924	P180	125 x 90 x 25	0/200	5906692005611

Brzeczoty bagnetowe

Sabre saw blade / Bajonett-Sägeblatt / Полотна / Полотна пильні з точним зубом / Orrfűrészlap / Panze bajoneta / Mečové pilové listy / Mečové pilové listy / Bajonetni žagani listi / Bimetaliniai pjūkliukai / Asmens zobenzāģim / Tüük-saelehed / Сменяема ленту за трион / Bajonet listovi pile / Oštrice noža / Προϊόνλαμας / Hojas de sable / Lama per sega a gattuccio / Láminas / Lames de scie à baionnette / Sabel mesbladen

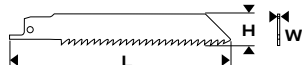

Ref.	L [mm]	H [mm]	W [mm]	TPI / mm			EAN
57-947	228	19	0.9	10	2	25/200	5906692013265
57-948	300	19	0.9	14	2	25/100	5906692013272
57-950	152	19	0.9	10/14	2	25/200	5906692013289
57-951	152	19	0.9	14	2	25/200	5906692013296
57-952	228	19	0.9	14	2	25/200	5906692013302
57-953	228	19	0.9	18	2	25/200	5906692013319
57-954	228	19	1.27	6	2	25/200	5906692013326

Brzeczot do pilarki szablastej

Blade for reciprocating saw / Sägeblatt für Säbelsäge / Пильное полотно для сабельной пилы / Полотно до шабельной пилки / Orrfűrész fűrészlap / Pánzä fierästräu sabie / Plový list pro šavlovou pilu / Čepel šablavej pily / List za sabljasto žago / Pjūkliukas tiesiniam pjūklui / Zobenzāģa asmenis / Saabelsae tera / Ножовка за саблен трион / List za sabljastu pilu / Sečivo za kružnu testeru / Προϊόνλαμα για απαβοσγα / Hoja de sierra para sierra de sable / Lama per sega a gattuccio / Lámina para serra de sabre / Lama de scie sabre / Mes voor sabelzaag

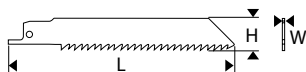

Ref.	TPI	L [mm]	H [mm]	W [mm]		EAN
58-040	18	152	19	0.9	25/200	5906692006243

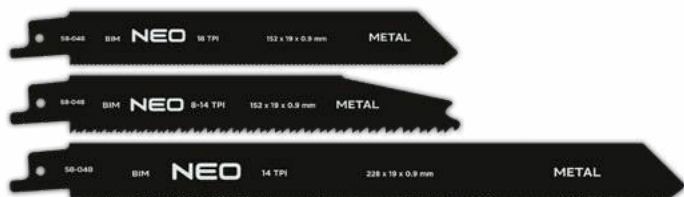
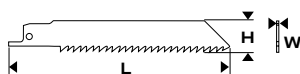

Ref.	TPI	L [mm]	H [mm]	W [mm]		EAN
58-048	24 8 14 14	152 152 228	19	0.9	5/40	5906692006328

Statyw do szlifierek kątowych

Angle grinder support / Gestell für Winkelschleifer / Держатель для угловых шлифмашин / Штатив до шлифмашинок кутовых (болгарок) / Állvány sarokcsiszolóhoz / Stativ pentru polizor unghiular / Stojan na uhlové brusky / Stojan na uhlové brusky / Stojalo za kotni brusilnik / Stovas kampiniam šlifuoekliui / Leřka sliřmařinas stativs / Statiiv nurklivijale / Статив за ъглошлайф / Stativ za kutne brusilice / Stativ za ugaone brusilice / Ορθοστάτης για γωνιακούς λειαντήρες / Soporte para amoladora angular / Supporto per smerigliatrice angolare / Suporte para esmerilhadora de canto / Bâti pour meuleuses d'angle / Steun voor verstekschuurmachines

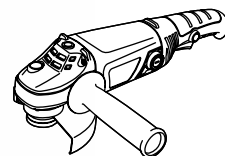
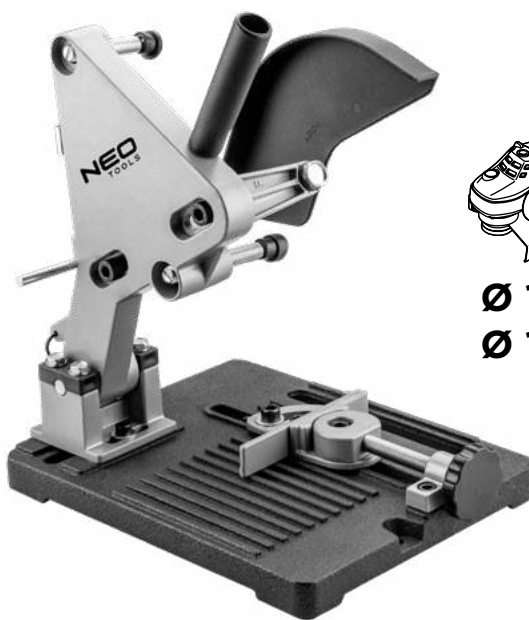

Ø 115 mm
Ø 125 mm

Ref		EAN
56-650	0/4	5906692007974

Statyw do wiertarki

Drill stand / Gestell für Bohrmaschine / Держатель для дрели / Штатив до дрелки / Fúróállvány / Stativ pentru masina de gaurit / Stojan na vrtačku / Stojan na vrtačku / Stojalo za vrtalnik / Stovas gręřtuvui / Urbjmařinas stativs / Statiiv trellile / Статив за пробивна машина / Stativ za bušilicu / Stativ za bušilicu / Ορθοστάτης βραχάνου / Soporte para taladradoras / Supporto per trapano / Suporte de berbequim / Bâti pour perceuse / Steun voor boormachine

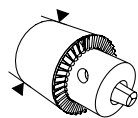

Ø 43 mm

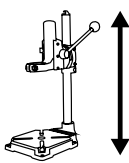

400mm

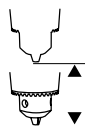

max 60 mm

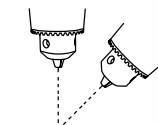

max 90°



Ref		EAN
56-655	0/6	5906692007981

Brzeszczot

Bow saw blade / Sägeblatt / Полотно ножовочное / Полотно до ножівки лучкової / Fűrészlap multifunkciós géphez / Lama ferástráiu cu arc / List pily / Plátok náhradný / Rezilni list / Geležite / Asmenis lokžajim / Vibusae leht / Лист за трион бичкня / List Pile / List testere / Λεπίδα για τοξοπίριο / Hoja de sierra de arco / Lama per metallo HSS / Lâmina / Lame de scie

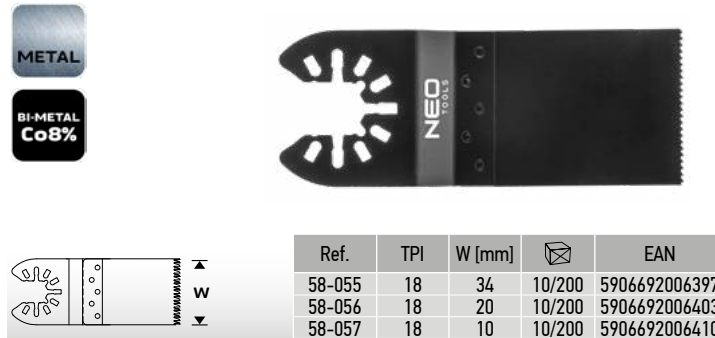
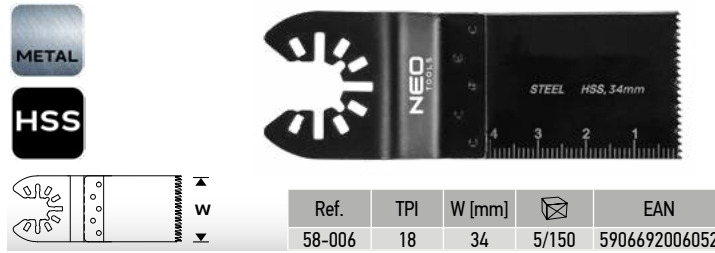

Skrobak sztywny

Stiff scraper / Schaber / steif / Скребок жесткий / Скребок жорсткий / Fa kaparó multigéphez / Răzuitor rigid / Tuhý škrabák / Tvrdá špachtla / Togo strgalo / Grandiklis tiesus / Stingsraskiklis / Jäik kaabits / Търъп шабър / Kruta strugalica / Grubi šabler / Σκληρή ξύστρα / Rasqueta no elástica / Raschietto rigido per legno / Raspador duro / Racle rigide

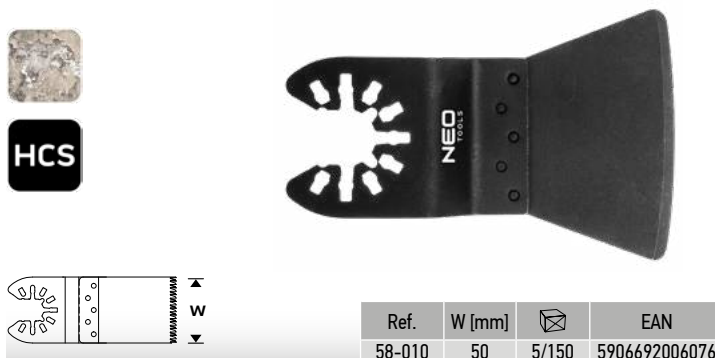

Papiery szlifierskie

Sanding paper / Schleifpapier / Бумага наждачная / Папир наждачний / Csiszolópapír multigéphez / Hírtie šmirghe ce se încheie singură / Brusný papír / Papier brúsný-rolka / Brusni papir / Šlifavimo papierius / Slipšpāpīrs / Liivaraber / Шкурна роло / Brusni papir u roli / Brusni papir / Λειαντικό ύφασμα / Lija / Carta abrasiva / Folha de lixa / Papier abrasif

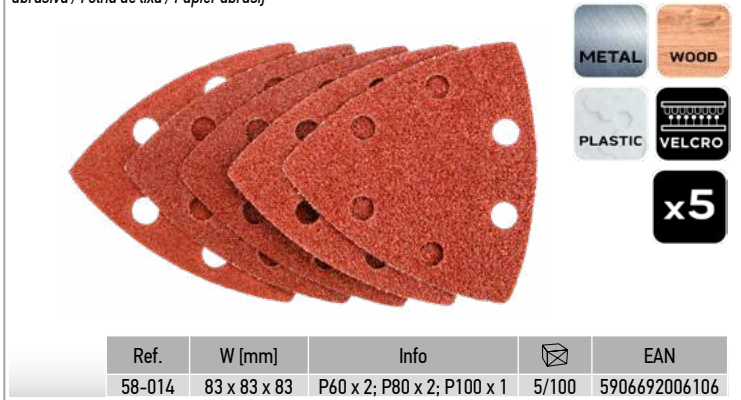

Stopa szlifierska

Sanding pad / Schleifteller / Шлифовальная подошва / Шлифовальна поверхня трикутна / Csiszolófej multigéphez / Talpă de șlefuit / Brusná deska / Pracovná pätká brusky / Brusna plošča / Šlifavimo padas / Slipšpāpīrs pēda / Lihvtald / Шлифовъчен плоч / Brusni tanjur / Postolje za brušenje / Πλάκα λειανσης / Placa lijadora / Piastra levigatrice / Complemento da lixa / Plateau de ponçage



Adapter do urządzenia wielofunkcyjnego

Multi-purpose adapter / Adapter für Multifunktionsgerät / Переходник для многофункционального устройства / Adapter для багатифункционального пристрою / Adapter univerzális berendezéshez / Adaptor pentru dispozitiv multifuncțional / Adaptor pro multifunkční zařízení / Adaptor pre multifunkčné zariadenie / Priključek za večnamensko napravo / Daugiafunkcio iřenginio adapteris / Adapteris daudzfunkcionāli iekārtai / Multifunktsionāle seadme adapter / Adapter за мултифункционално устройство / Adapter za višenamjenski uređaj / Adapter za višefunkcionalne uređaje / Προσαρμογέας πολυεργαλείων / Adaptador para el dispositivo multifunción / Adattatore per il dispositivo multifunzionale / Adaptador para o dispositivo multifunção / Adaptateur pour le dispositif multifonction / Adapter voor multifunctioneel apparaat

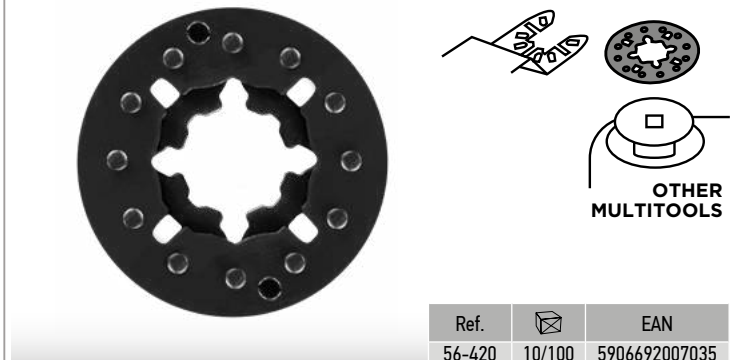

Filc polerski

Polishing felt / Polierfilz / Фетр полировочный / Фільтр полірувальний / Polírkorong / Píslä šlefuire / Leštící plst / Filcový disk / Filc za poliranje / Veltinis poliravimui / Filcis pulēšanas / Poleerimisvilt / Диск за полиране / Filc za poliranje / Filc za poliranje / Τάχα γυαλισματος / Fietlo para pulir / Fietlo per lucidatura / Fietlo para poli / Feutre de polissage / Polijstvilt

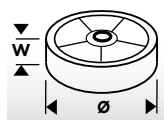

Ref.	Ø [mm]	W [mm]	☒	EAN
08-960	75	10	1/100	5907558454505
08-961	125	10	1/100	5907558454512
08-962	125	20	1/100	5907558454529

Tarcza elastyczna

Backing pad / Flexible Scheibe / Эластичный диск / Диск еластичний / Elastikus tárcsa / Disc elastic / Elastický kotouč / Elastický kotúč / Elastična ploča / Elastinis diskas / Elastigais disks / Elastne kets / Эластичен диск / Elastična ploča / Elastična ploča / Ελαστικός δίσκος / Disco elástico / Disco elastico / Disco elástico / Disque flexible / Flexibele schijf

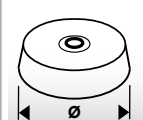

Ref.	Ø [mm]	☒	EAN
08-977	75	1/100	5907558454673
08-968	125	1/100	5907558454581

Pad polerski

Foam pad / Polierkissen / Полировальная подушка / Попироваљнајна подушка / Polirozó betét / Tampon de lustruit / Leštící podložka / Leštiaca podložka / Blazinica za poliranje / Poliravimo padas / Pulēšanas spilventiņš / Poleerimisradi / Полирацца гъба / Spružna za poliranje / Подлога за полирање / Σπόγγος στίλβωσης / Almohadilla de pulido / Tampone per lucidatura / Almofada de polimento / Tampon de polissage / Polijstpad

CUTTING POLISHING FINISHING

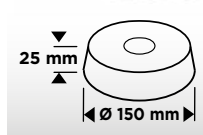
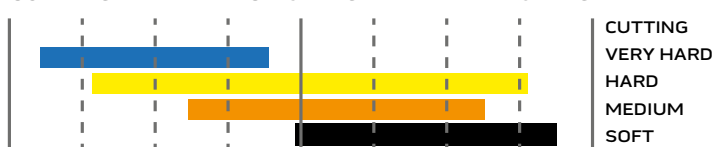

Ref.	info	Ø [mm]	☒	EAN
08-963	cutting	150	1/100	5907558454536
08-964	very hard	150	1/100	5907558454543
08-965	hard	150	1/100	5907558454550
08-966	medium	150	1/100	5907558454567
08-967	soft	150	1/100	5907558454574

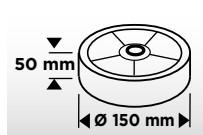

Ref.	info	Ø [mm]	☒	EAN
08-969	cutting	150	1/100	5907558454598
08-970	very hard	150	1/100	5907558454604
08-971	hard	150	1/100	5907558454611
08-972	medium	150	1/100	5907558454628
08-973	soft	150	1/100	5907558454635

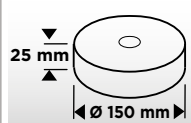

Ref.	info	Ø [mm]	☒	EAN
08-978	cutting	150	1/100	5907558495157
08-979	very hard	150	1/100	5907558495164
08-980	hard	150	1/100	5907558495171
08-981	medium	150	1/100	5907558495188
08-982	soft	150	1/100	5907558495195

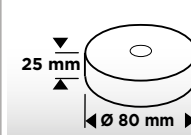

Ref.	info	Ø [mm]	☒	EAN
08-974	hard	80	1/100	5907558454642
08-975	medium	80	1/100	5907558454659
08-976	soft	80	1/100	5907558454666

Końcówki wkrętakowe z uchwytem

Screwdriver bits with holder / Einsätze für Schraubendreher mit Aufnahme / Набор насадок с держателем / Наконечники викруткові, з руків'ям / Csavarhúzó cserélhető fejj / Set biti cu suport capat / Šroubovákové nástavce s držadlem / Skrutkovacie nástavce s upínadlom / Nastavki za izvijač z vpenjalom / Atsuktuvo antgaliai su laikikliu / Skrvngrieža uzgāju komplekts ar turētāju / Krivikeerajatsakud koos käepidemega / Накраїниці за отвертка с держач / Nastavci za odvijač s hvataljkom / Nastavci za odvijač s drškom / Σετ με καταβιδώματα και προσαρμογέα / Puntas destornilladoras con mango / Set inserti con supporto / Ponteiros Chave de fenda com Suporte / Embouts de tournevis de précision avec manche / Schroevendraaiereindstukken met handvat

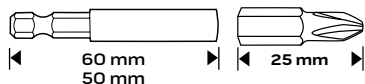

⊖ 3, 4, 4.5, 5.5, 6, 6.5, 7, 8 mm

⊕ PH0, PH1, PH2, PH3

⊕ PZ0, PZ1, PZ2, PZ3

⊕ T8, T10, T15, T20, T25, T27, T30, T40, T45

⊕ HT2, HT2.5, HT3, HT4, HT5, HT6
5/64, 3/32, 7/64, 1/8, 9/64, 5/32"

⊕ M5, M6, M8
6, 8, 10 mm

⊕ 2, 3, 4 mm
1, 2, 3 mm

⊕ 4, 6, 8, 10 mm

⊕ No0, No1, No2, No3

⊕ TT8, TT10, TT15, TT20, TT25,
TT27, TT30, TT35, TT40

H1.5, H2, H2.5, H3, H4, H5, H5.5, H6, H8

⊕ H1/16, H5/64, H3/32, H7/64, H1/8,
H9/64, H5/32, H3/16, H7/32, H1/4"

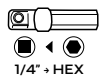

Ref.	⊕	EAN
06-104	6/24	5907558406245



⊖ 3, 4, 5, 6 mm

⊕ PH1, PH2, PH3

⊕ PZ1, PZ2, PZ3

⊕ T10, T15, T20, T25, T27, T30, T40

⊕ TT10, TT15, TT20, TT25, TT27, TT30, TT40

⊕ H2, H2.5, H3, H4, H5, H6

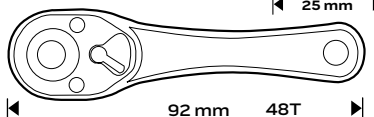

Ref.	⊕	EAN
06-105	6/36	5907558402315

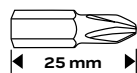
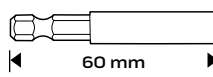

⊖ 3, 4, 5, 6 mm

⊕ PH1, PH2, PH3

⊕ PZ1, PZ2, PZ3

⊕ H3, H4, H5, H6

⊕ T10, T15, T20, T25, T27, T30, T40

⊕ TT10, TT15, TT20, TT25, TT27, TT30, TT40

Ref.	⊕	EAN
06-103	6/24	5907558402346

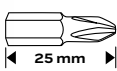
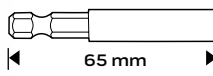

⊖ 3, 4, 5, 6 mm

⊕ PH1, PH2, PH3

⊕ PZ1, PZ2, PZ3

⊕ H3, H4, H5, H6

⊕ T10, T15, T20, T25, T27, T30, T40

⊕ TT10, TT15, TT20, TT25, TT27, TT30, TT40

Ref.	⊕	EAN
06-106	12/48	5907558410143

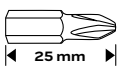
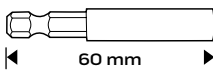

⊖ 4.5, 6 mm

⊕ PZ1, PZ2

⊕ T15, T20

Ref.	⊕	EAN
06-101	12/120	5907558402339

Uchwyt do końcówek

Bit holder / Aufnahme für Spitzen / Зажим для наконечников / Тримач до наконечників / Csavarbehajtószer / Dispozitiv de prinderea capetelor / Skličidlo na nástavce / Upínadlo na nástavce / Vpenjalo za nastavke / Laikiklis antgaliams / uzgaļu patrona / Държач за накрайници / дрška za nastavke / Hvata za nastavke / Προσαρμογέας μπιτών / Mandril de sujeción para puntas / Innesto per inserti con impugnatura / Suporte de ponteiros / Manche pour embouts / Houder voor eindstukken

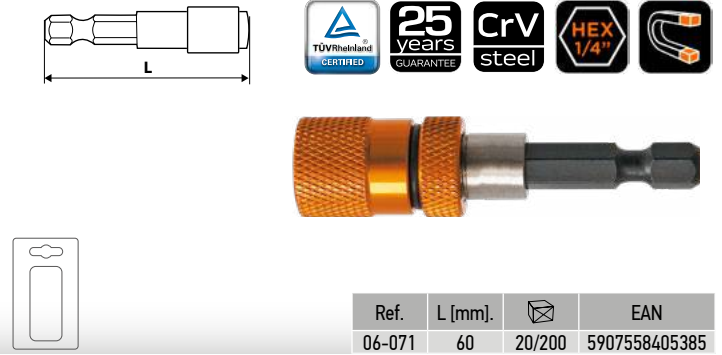
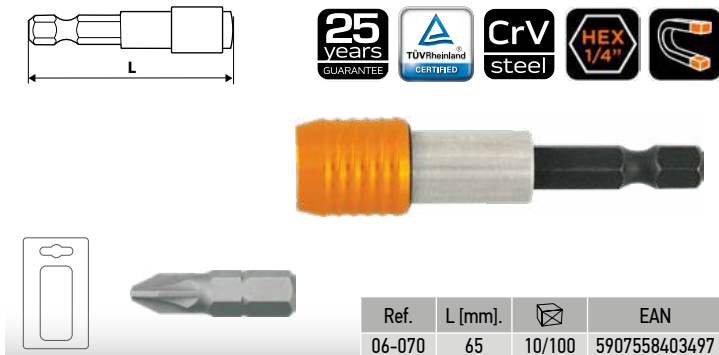

Końcówki wkrętakowe

Driver bits / Einsätze für Schraubendreher / Насадки / Наконечники викруток / Csavarhúzó hegyek / Set biti / Šroubovákové nástavce / Skrutkovacie nástavce / Nastavki za izvijače / Atsuktuvo antgaliai / Skrūvgrieža uzgaļi / Krivikeeraajatsakud / Накрайници за отвертка / Nastavci za odvijač / Nastavci za odvijač / Καταβιδόμενες / Puntas destornilladoras / Inserti / Ponteiros de chave de fenda / Embouts de tournevis / Schroevendraaiereindstukken

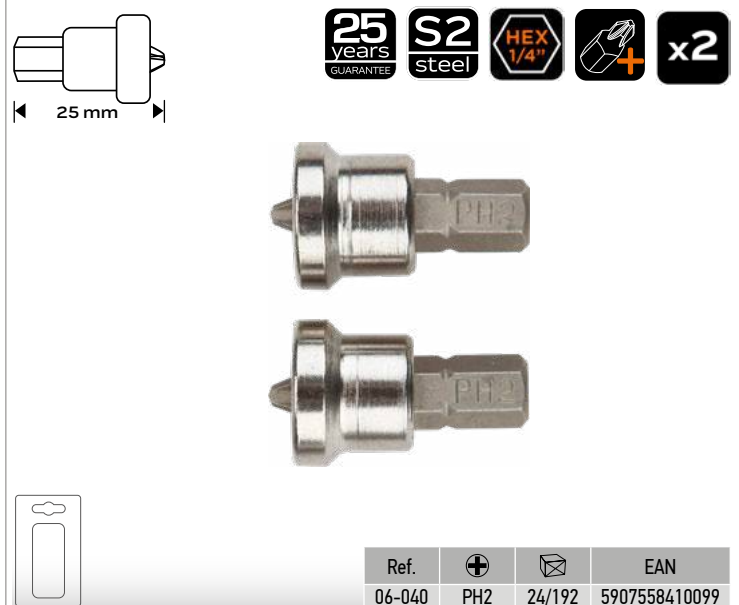
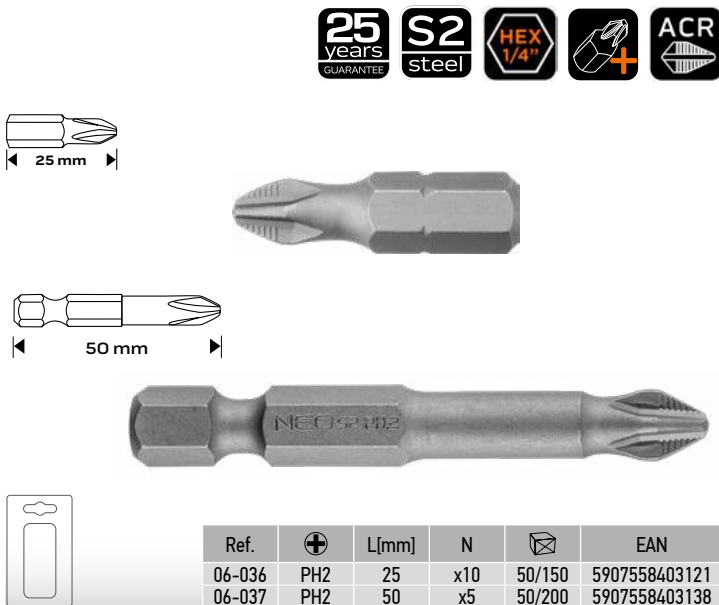

Uchwyt magnetyczny

Magnetic holder / Magnetaufnahme / Держатель магнитный / Патрон магнітний / Toldósár behajt / Suport magnetic / Magnetický držák / Magnetické sklúčovadlo / Magneto vpenjalo / Magnetinis griebtuvas / Magnētiskais turētājs / Magnetpadrun / Магнітен държач / Magneta hvatačka / Magneta drška / Υποδοχή μαγνητική / Mandril de sujeción magnético / Porta inserti con giunta sferica / Suporte magnética / Manche magnétique / Magnetisch houder

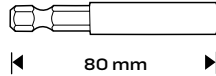

Ref.	L [mm]	⊠	EAN
56-554	60	10/100	5906692025558

Adapter

Adaptor / Adapter / Адаптер / Перехідник / Közdarab, adapter / Adaptor / Adaptér / Adaptér / Adapter / Jungtis / Adapteris / Adapter / Адаптер / Adapter / Adapter / Αντάπτορας / Adaptador / Adattatore / Adaptador / Adaptateur / Adapter

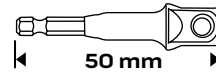

Ref.	Info	⊠	EAN
56-555	1/4" HEX -> 1/4" □	10/100	5906692007578
56-556	1/4" HEX -> 1/2" □	10/100	5906692007561

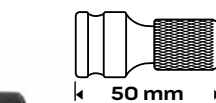

Ref.	Info	⊠	EAN
56-557	1/4" HEX -> 1/2" □	20/40	5906692007585

Przedłużka

Extension / Erweiterung / Расширение / Rozšíření / Hosszabbítás / Extensie / Prodloužení / Rozšírenie / Podaljšek / Pratešimas / Paplašinājums / Píkendus / Удължение / Proširenje / Продужетка / Еπεκταση / Extensión / Estensione / Extensão / Extension / Uitbreiding

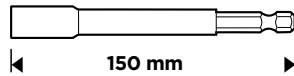

Ref.	L [mm]	⊠	EAN
56-558	150	10/40	5906692007592

Биты ударовые

Impact bits / Schlag-Bits / Ударные вставки / Бити ударні / Ütvecsavarozó bitek / Bit de impact / Úderové bity / Nárazové bity / Udarni biti / Smúginjani antgaliai / Triecienuzgaļi / Löökmeislid / Ударни битове / Udarni bitovi / Udarni bitovi / Κρουστικές μύτες / Bits de impacto / Inserti a percussione / Pontas de percussão / Embouts à choc / Slagbits



Ref.	Info	L [mm]	⊠	⊠	EAN
56-500	PH1	25	2	50/100	5906692007059
56-501	PH2	25	2	50/100	5906692007066
56-502	PH3	25	2	50/100	5906692007073



Ref.	Info	L [mm]	⊠	⊠	EAN
56-503	PZ1	25	2	50/100	5906692007080
56-504	PZ2	25	2	50/100	5906692007097
56-505	PZ3	25	2	50/100	5906692007103
56-506	PZ4	25	2	50/100	5906692007110



Ref.	Info	L [mm]	⊠	⊠	EAN
56-507	HEX4	25	2	0/50	5906692007127
56-508	HEX5	25	2	50/100	5906692007134
56-509	HEX6	25	2	50/100	5906692007141

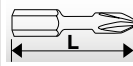

Ref.	Info	L [mm]	⊠	⊠	EAN
56-510	SL5.5	25	2	50/100	5906692007158
56-511	SL6.5	25	2	50/100	5906692007165



Ref.	Info	L [mm]	⊠	⊠	EAN
56-512	TX15	25	2	50/100	5906692007172
56-513	TX20	25	2	50/100	5906692007189
56-514	TX25	25	2	50/100	5906692007196
56-515	TX27	25	2	50/100	5906692007202
56-516	TX30	25	2	50/100	5906692007219
56-517	TX40	25	2	50/100	5906692007226

Bity udarowe

Impact bits / Schlag-Bits / Ударные вставки / Бити ударни / Útvecsavarozó bitek / Bit de impact / Úderové bity / Nárazové bity / Udarni biti / Smūginiai antgaliai / Triecienuzgaļi / Löökmeislid / Ударни бумосе / Udarni bitovi / Udarni bitovi / Κρουστικές μύτες / Bits de impacto / Insetti a percussione / Pontas de percussão / Embouts à choc / Slagbits



Ref.	Info	L [mm]			EAN
56-518	PH1	50	2	50/100	5906692007233
56-519	PH2	50	2	50/100	5906692007240
56-520	PH3	50	2	50/100	5906692007257

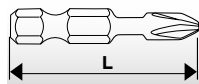

Ref.	Info	L [mm]			EAN
09-575	PH1	50	5	12/96	5907558450484
09-576	PH2	50	5	12/96	5907558450491
09-577	PH3	50	5	12/96	5907558450507

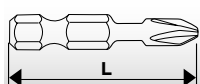

Ref.	Info	L [mm]			EAN
56-521	PZ1	50	2	50/100	5906692007264
56-522	PZ2	50	2	50/100	5906692007271
56-523	PZ3	50	2	50/100	5906692007288

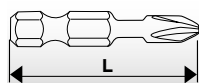

Ref.	Info	L [mm]			EAN
09-579	PZ2	50	5	12/96	5907558450521
09-580	PZ3	50	5	12/96	5907558450538

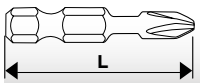

Ref.	Info	L [mm]			EAN
56-524	TX15	50	2	50/100	5906692007295
56-525	TX20	50	2	50/100	5906692007301
56-526	TX25	50	2	50/100	5906692007318
56-527	TX27	50	2	50/100	5906692007325
56-528	TX30	50	2	50/100	5906692007332
56-529	TX40	50	2	50/100	5906692007349

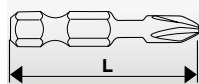

Ref.	Info	L [mm]			EAN
09-584	TX20	50	5	12/96	5907558450576
09-585	TX25	50	5	12/96	5907558450583
09-587	TX30	50	5	12/96	5907558450606
09-588	TX40	50	5	12/96	5907558450613

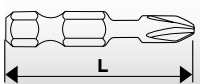

Ref.	Info	L [mm]			EAN
56-543	PH1/PH2/PH3	50	3	50/100	5906692007455

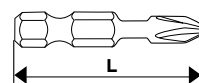

Ref.	Info	L [mm]			EAN
56-542	PZ1/PZ2/PZ3	50	3	50/100	5906692007448

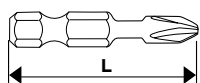

Bity udarowe

Impact bits / Schlag-Bits / Ударные вставки / Биту ударни / Útvecsavarozó bitek / Bit de impact / Úderové bity / Nárazové bity / Udarni biti / Smūginiai antgaliai / Triecienuzgaļi / Löökmeislid / Ударни битоше / Udarni bitovi / Udarni bitovi / Κρουστικές μύτες / Bits de impacto / Inserti a percussione / Pontas de percussão / Embouts à choc / Schlagbits



Ref.	Info	L [mm]	📦	📦	EAN
56-540	PH1/PH2/PH3, PZ1/PZ2/PZ3	25	6	50/100	5906692007424



Ref.	Info	L [mm]	📦	📦	EAN
56-544	TX15	25	20	10/100	5906692007462
56-545	TX20	25	20	10/100	5906692007479
56-546	TX25	25	20	10/100	5906692007486
56-547	TX30	25	20	10/100	5906692007493

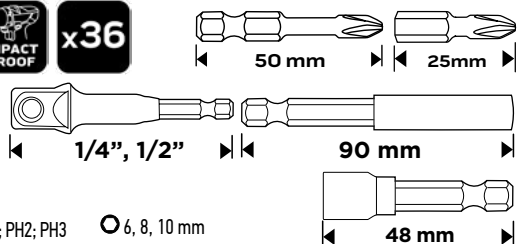

- 25 mm
 ⚙ PH1; PH2; PH3
 ⚙ PZ1; PZ2; PZ3
 ⚙ T10; T15; T20; T25; T27; T30; T40
- 50 mm
 ⚙ PH1; PH2; PH3
 ⚙ PZ1; PZ2; PZ3
 ⚙ H3; H4; H5; H6
- ⊙ 6, 8, 10 mm



Ref.	📦	📦	EAN
56-560	36	0/10	5906692007615



Ref.	Info	L [mm]	📦	📦	EAN
56-541	TX10/TX15/TX20 TX25/TX30/TX40	25	6	50/100	5906692007431



Ref.	Info	L [mm]	📦	📦	EAN
56-530	PH1	25	20	10/100	5906692007356
56-531	PH2	25	20	10/100	5906692007363
56-532	PH3	25	20	10/100	5906692007370



Ref.	Info	L [mm]	📦	📦	EAN
56-533	PZ1	25	20	10/100	5906692007387
56-534	PZ2	25	20	10/100	5906692007394
56-535	PZ3	25	20	10/100	5906692007400
56-536	PZ4	25	20	10/100	5906692007417



- ⚙ PH1; PH2 PH3
 ⚙ PZ1; PZ2; PZ3
 ⚙ T25; T27; T30; T40



Ref.	L [mm]	📦	📦	EAN
56-562	50	10	20/80	5906692007622

Końcówki wkrętaskowe

Driver bits / Einsätze für Schraubendreher / Насадки / Наконечники викруток / Csavarhúzó bit / Set biti / Šroubovákové nástavce / Skrutkovicie nástavce / Nastavki za izvijače / Atsuktuvo antgaliai / Skrūvgrieža uzgaļi / Kruvikeerajaotsakud / Накрайники за отвертка / Nastavci za odvijač / Nastavci za odvijač / Καταβιδόμετες / Puntas destornilladoras / Punta giravite / Ponteiros Chave de fenda / Embouts de tournevis / Schroevendraaierendstukken

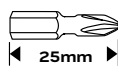
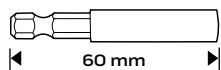

- PH2, PH3
- PZ2, PZ3
- H4, H5, H6
- T20, T25, T30, T40

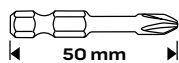

- PH2
- PZ2
- T20, T30

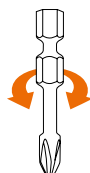

SAFETY FORCE

Ref.	⊠	EAN
56-612	12/48	5906692007813

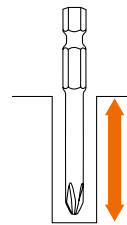
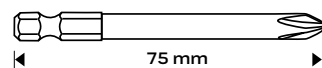

DEEP DRIVE

- PH1, PH2, PH3
- PZ1, PZ2, PZ3
- SL4, SL6
- H3, H4, H5
- T10, T15, T20, T25, T27, T30, T40

Ref.	⊠	EAN
56-606	6/24	5906692007776

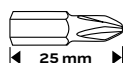
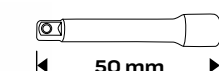
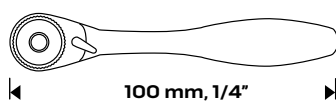

- PH1, PH2, PH3
- PZ1, PZ2, PZ3
- SL4, SL5.5, SL6.5
- H3, H4, H5, H6
- TT10, TT15, TT20, TT25, TT30
- 6, 7, 8, 10, 13 mm

Ref.	⊠	EAN
56-604	6/24	5906692007769

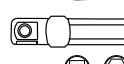
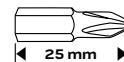
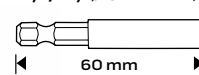
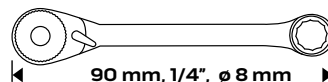

1/4" x HEX



- PH1, PH2
- PZ1, PZ2
- H4, H5, H6
- T10, T15, T20, T25, T30, T40
- 6, 7, 8, 10, 11, 13 mm

Ref.	⊠	EAN
56-610	12/48	5906692007790

Kątowna nasadka wiertarska

Drill chuck / Bohrfutter / Патрон для дрели / Патрон до дрелю / Fúrótokmány / Mandrină de găurit / Skličadlo pro vrtáky / Slučidlo / Vrtalna glava / Griebtuvas gręžtuvui / Urbjmašinas patrona / Drelli padrun / Патрон за бормашина / Stezna glava-borfuter / Stezna glava-borfuter / Кенτροσφικτής δράπανου / Portabrocas / Manubrio di trapano per chiave / Suporte de berbequim / Mandrin de perçage / Boorhouder



Ref.	∅ [mm]	⊠	EAN
55-932	0.8 - 10	6/24	5906692005697

Nasadka uniwersalna

Versatile adapter / Universalaufsatz / Универсальная насадка / Універсальна насадка / Univerzális tartó / Ataşament universal / Univerzálný nástavec / Univerzálny nadstavec / Univerzalni nastavek / Universalus antgalis / Universāla uzstava / Universaalhe otsak / Універсальна приставка / Univerzalni nastavak / Univerzalni nasadni ključ / Μύτη γενικής χρήσεως / Llave de vaso universal / Carpuccio universale / Acessório universal / Fixation universelle / Universeel dop

1/4"-3/4"
7 mm - 19 mm



Ref.	⊠	EAN
55-224	1/50	5906692003266

ВНР

OHS охорона праці



Spodnie robocze

Working trousers / Arbeitshose / Брюки рабочие / Штани робочі / Munkadzseki / Pantaloni de lucru / Pracovní kalhoty / Montérky / Delovne hlače / Darbinės kelnės / Darba bikses / Tööpüksid / Работни панталони / Radne hlače / Radne pantalone / Παντελόν εργασιών / Pantalón de trabajo / Pantaloni da lavoro / Calças de trabalho / Pantalon de travail



COTON 62%
POLYESTER 35%
ELASTANE 3%

270g/m²

PROFILED

CE

ORIGINAL DESIGN
Created by NEO

Ref.	Size	☒	EAN
81-226-XS	XS/46	12/24	5907558446654
81-226-S	S/48	12/24	5907558446661
81-226-M	M/50	12/24	5907558446678
81-226-L	L/52	12/24	5907558446685
81-226-XL	XL/54	12/24	5907558446692
81-226-XXL	XXL/56	12/24	5907558446708
81-226-XXXL	XXXL/58	12/24	5907558446715



POLYAMIDE 90%
ELASTANE 10%

170g/m²

4-WAY STRETCH

PROFILED

CE

ORIGINAL DESIGN
Created by NEO

Ref.	Size	☒	EAN
81-290-XS	XS/46	0/30	5907558497038
81-290-S	S/48	0/30	5907558497045
81-290-M	M/50	0/30	5907558497052
81-290-L	L/52	0/30	5907558497069
81-290-XL	XL/54	0/30	5907558497076
81-290-XXL	XXL/56	0/30	5907558497083
81-290-XXXL	XXXL/58	0/30	5907558497090



POLYAMIDE 90%
ELASTANE 10%

170g/m²

PROFILED

4-WAY STRETCH

CE

ORIGINAL DESIGN
Created by NEO

Ref.	Size	☒	EAN
81-231-XS	XS/46	0/20	5907558447071
81-231-S	S/48	0/20	5907558447088
81-231-M	M/50	0/20	5907558447095
81-231-L	L/52	0/20	5907558447101
81-231-XL	XL/54	0/20	5907558447118
81-231-XXL	XXL/56	0/20	5907558447125
81-231-XXXL	XXXL/58	0/20	5907558447132



COTON 60%
POLYESTER 37%
ELASTANE 3%

285g/m²

STITCH

PROFILED

CE

ORIGINAL DESIGN
Created by NEO

Ref.	Size	☒	EAN
81-239-XS	XS/46	0/20	5907558451726
81-239-S	S/48	0/20	5907558451733
81-239-M	M/50	0/20	5907558451740
81-239-L	L/52	0/20	5907558451757
81-239-XL	XL/54	0/20	5907558451764
81-239-XXL	XXL/56	0/20	5907558451771
81-239-XXXL	XXXL/58	0/20	5907558451788



TÜV Rheinland CERTIFIED

STITCH x3

POLYESTER 65%
COTTON 35%

267g/m²

POCKET

CE

Ref.	Size	☒	EAN
81-220-S	S/48	0/10	5907558419085
81-220-M	M/50	0/10	5907558419092
81-220-L	L/52	0/10	5907558419108
81-220-LD	L/54	0/10	5907558419115
81-220-XL	XL/56	0/10	5907558419122
81-220-XXL	XXL/58	0/10	5907558419139



TÜV Rheinland CERTIFIED

POLYESTER 65%
COTTON 35%

267g/m²

2 in 1

POCKET

CE

Ref.	Size	☒	EAN
81-230-S	S/48	0/10	5907558419146
81-230-M	M/50	0/10	5907558419153
81-230-L	L/52	0/10	5907558419160
81-230-LD	L/54	0/10	5907558419177
81-230-XL	XL/56	0/10	5907558419184
81-230-XXL	XXL/58	0/10	5907558419191

Spodnie robocze

Working trousers / Arbeitshose / Брюки рабочие / Штаны рабочие / Munkadzseki / Pantaloni de lucru / Pracovní kalhoty / Montérky / Delovne hlače / Darbinės kelnės / Darba bikses / Töörüpsid / Работни панталони / Radne hlače / Radne pantalone / Παντελόνι εργασίας / Pantalón de trabajo / Pantaloni da lavoro / Calças de trabalho / Pantalon de travail

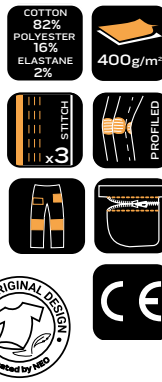

Ref.	Size	⊠	EAN
81-361-1-XS	XS/46	0/12	5906692015184
81-361-1-S	S/48	0/12	5906692015191
81-361-1-M	M/50	0/12	5906692015207
81-361-1-L	L/52	0/12	5906692015214
81-361-1-XL	XL/54	0/12	5906692015221
81-361-1-XXL	XXL/56	0/12	5906692015238
81-361-1-XXXL	XXXL/58	0/12	5906692015245

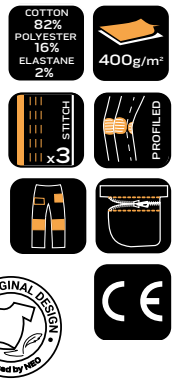

Ref.	Size	⊠	EAN
81-361-2-XS	XS/46	0/12	5906692015252
81-361-2-S	S/48	0/12	5906692015269
81-361-2-M	M/50	0/12	5906692015276
81-361-2-L	L/52	0/12	5906692015283
81-361-2-XL	XL/54	0/12	5906692015290
81-361-2-XXL	XXL/56	0/12	5906692015306
81-361-2-XXXL	XXXL/58	0/12	5906692015313

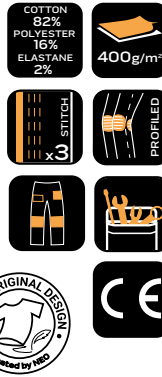

Ref.	Size	⊠	EAN
81-360-1-XS	XS/46	0/20	5906692015047
81-360-1-S	S/48	0/20	5906692015054
81-360-1-M	M/50	0/20	5906692015061
81-360-1-L	L/52	0/20	5906692015078
81-360-1-XL	XL/54	0/20	5906692015085
81-360-1-XXL	XXL/56	0/20	5906692015092
81-360-1-XXXL	XXXL/58	0/20	5906692015108

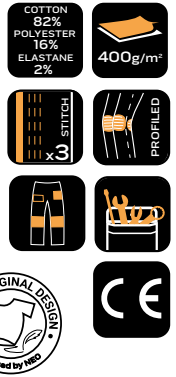

Ref.	Size	⊠	EAN
81-360-2-XS	XS/46	0/20	5906692015115
81-360-2-S	S/48	0/20	5906692015122
81-360-2-M	M/50	0/20	5906692015139
81-360-2-L	L/52	0/20	5906692015146
81-360-2-XL	XL/54	0/20	5906692015153
81-360-2-XXL	XXL/56	0/20	5906692015160
81-360-2-XXXL	XXXL/58	0/20	5906692015177

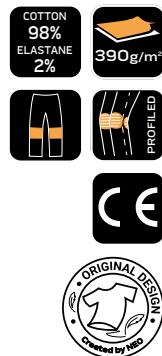

Ref.	Size	⊠	EAN
81-236-XS	XS/46	0/20	5907558467840
81-236-S	S/48	0/20	5907558467857
81-236-M	M/50	0/20	5907558467864
81-236-L	L/52	0/20	5907558467871
81-236-XL	XL/54	0/20	5907558467888
81-236-XXL	XXL/56	0/20	5907558467895
81-236-XXXL	XXXL/58	0/20	5907558467901



Ref.	Size	⊠	EAN
81-228-XS	XS/46	0/20	5907558439427
81-228-S	S/48	0/20	5907558439434
81-228-M	M/50	0/20	5907558439441
81-228-L	L/52	0/20	5907558439458
81-228-XL	XL/54	0/20	5907558439465
81-228-XXL	XXL/56	0/20	5907558439472
81-228-XXXL	XXXL/58	0/20	5907558439489

Spodnie robocze

Working trousers / Arbeitshose / Брюки рабочие / Штаны рабочие / Munkdazseki / Pantaloni de lucru / Pracovní kalhoty / Montérky / Delovne hlače / Darbinės kelnės / Darba bikses / Tööpüksid / Работни панталони / Radne hlače / Radne pantalone / Παντελόν εργασιών / Pantalón de trabajo / Pantaloni da lavoro / Calças de trabalho / Pantalon de travail



COTTON 98%
ELASTANE 2%

410g/m²



Ref.	Size	☒	EAN
81-233-XS	XS/46	0/20	5907558467703
81-233-S	S/48	0/20	5907558467710
81-233-M	M/50	0/20	5907558467727
81-233-L	L/52	0/20	5907558467734
81-233-XL	XL/54	0/20	5907558467741
81-233-XXL	XXL/56	0/20	5907558467758
81-233-XXXL	XXXL/58	0/20	5907558467765



COTTON 98%
ELASTANE 2%

410g/m²



finalist
of the competition



2020

Ref.	Size	☒	EAN
81-229-XS	XS/46	0/20	5907558439496
81-229-S	S/48	0/20	5907558439502
81-229-M	M/50	0/20	5907558439519
81-229-L	L/52	0/20	590755843127
81-229-XL	XL/54	0/20	5907558443134
81-229-XXL	XXL/56	0/20	5907558439540
81-229-XXXL	XXXL/58	0/20	5907558439557



POLYESTER 65%
COTTON 35%



245g/m²

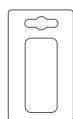

Ref.	Size	☒	EAN
81-420-S	S/48	0/10	5907558415445
81-420-M	M/50	0/10	5907558415452
81-420-L	L/52	0/10	5907558415469
81-420-LD	L/54	0/10	5907558415476
81-420-XL	XL/56	0/10	5907558415483
81-420-XXL	XXL/58	0/10	5907558415490



COTTON 50%
POLYESTER 37%
ELASTANE 3%

285g/m²



Ref.	Size	☒	EAN
81-238-XS	XS/46	0/20	5907558451658
81-238-S	S/48	0/20	5907558451665
81-238-M	M/50	0/20	5907558451672
81-238-L	L/52	0/20	5907558451689
81-238-XL	XL/54	0/20	5907558451696
81-238-XXL	XXL/56	0/20	5907558451702
81-238-XXXL	XXXL/58	0/20	5907558451719



PADDING



WARM



Ref.	Size	☒	EAN
81-565-S	S/48	0/10	5907558428247
81-565-M	M/50	0/10	5907558428254
81-565-L	L/52	0/10	5907558428261
81-565-XL	XL/56	0/10	5907558428278
81-565-XXL	XXL/58	0/10	5907558428285
81-565-XXXL	XXXL/60	0/10	5907558428292

Spodnie robocze

Working trousers / Arbeitshose / Брюки рабочие / Штаны рабочие / Munkadzseki / Pantaloni de lucru / Pracovní kalhoty / Montérky / Delovne hlače / Darbinės kelnės / Darba bikses / Töörpüksid / Работни панталони / Radne hlače / Radne pantalone / Παντελόνι εργασίας / Pantalón de trabajo / Pantaloni da lavoro / Calças de trabalho / Pantalon de travail



Ref.	Size	☒	EAN
81-296-1-XS	XS/46	0/20	5907558479096
81-296-1-S	S/48	0/20	5907558479102
81-296-1-M	M/50	0/20	5907558479119
81-296-1-L	L/52	0/20	5907558479126
81-296-1-XL	XL/54	0/20	5907558479133
81-296-1-XXL	XXL/56	0/20	5907558479140
81-296-1-XXXL	XXXL/58	0/20	5907558479157



Ref.	Size	☒	EAN
81-296-3-XS	XS/46	0/20	5907558479232
81-296-3-S	S/48	0/20	5907558479249
81-296-3-M	M/50	0/20	5907558479256
81-296-3-L	L/52	0/20	5907558479263
81-296-3-XL	XL/54	0/20	5907558479270
81-296-3-XXL	XXL/56	0/20	5907558479287
81-296-3-XXXL	XXXL/58	0/20	5907558479294



Ref.	Size	☒	EAN
81-295-1-XS	XS/46	0/20	5907558478884
81-295-1-S	S/48	0/20	5907558478891
81-295-1-M	M/50	0/20	5907558478907
81-295-1-L	L/52	0/20	5907558478914
81-295-1-XL	XL/54	0/20	5907558478921
81-295-1-XXL	XXL/56	0/20	5907558478938
81-295-1-XXXL	XXXL/58	0/20	5907558478945



Ref.	Size	☒	EAN
81-295-2-XS	XS/46	0/20	5907558478952
81-295-2-S	S/48	0/20	5907558478969
81-295-2-M	M/50	0/20	5907558478976
81-295-2-L	L/52	0/20	5907558478983
81-295-2-XL	XL/54	0/20	5907558478990
81-295-2-XXL	XXL/56	0/20	5907558479003
81-295-2-XXXL	XXXL/58	0/20	5907558479010



Ref.	Size	☒	EAN
81-298-1-XS	XS/46	0/20	5907558479300
81-298-1-S	S/48	0/20	5907558479317
81-298-1-M	M/50	0/20	5907558479324
81-298-1-L	L/52	0/20	5907558479331
81-298-1-XL	XL/54	0/20	5907558479348
81-298-1-XXL	XXL/56	0/20	5907558479355
81-298-1-XXXL	XXXL/58	0/20	5907558479362



Ref.	Size	☒	EAN
81-298-2-XS	XS/46	0/20	5907558479379
81-298-2-S	S/48	0/20	5907558479386
81-298-2-M	M/50	0/20	5907558479393
81-298-2-L	L/52	0/20	5907558479409
81-298-2-XL	XL/54	0/20	5907558479416
81-298-2-XXL	XXL/56	0/20	5907558479423
81-298-2-XXXL	XXXL/58	0/20	5907558479430

Spodnie robocze

Working trousers / Arbeitshose / Брюки рабочие / Штаны рабочие / Munkadzseki / Pantaloni de lucru / Pracovní kalhoty / Montérky / Delovne hlače / Darbinės kelnės / Darba bikses / Тööpüksid / Работни панталони / Radne hlače / Radne pantalone / Παντελόν εργασιών / Pantalón de trabajo / Pantaloni da lavoro / Calças de trabalho / Pantalon de travail



Ref.	Size	☒	EAN
81-298-3-XS	XS/46	0/20	5907558479447
81-298-3-S	S/48	0/20	5907558479454
81-298-3-M	M/50	0/20	5907558479461
81-298-3-L	L/52	0/20	5907558479478
81-298-3-XL	XL/54	0/20	5907558479485
81-298-3-XXL	XXL/56	0/20	5907558479492
81-298-3-XXXL	XXXL/58	0/20	5907558479508



Ref.	Size	☒	EAN
81-351-1-XS	XS/46	0/20	5907558478679
81-351-1-S	S/48	0/20	5907558478686
81-351-1-M	M/50	0/20	5907558478693
81-351-1-L	L/52	0/20	5907558478709
81-351-1-XL	XL/54	0/20	5907558478716
81-351-1-XXL	XXL/56	0/20	5907558478723
81-351-1-XXXL	XXXL/58	0/20	5907558478730

Spodnie robocze ogrodniczki

Working dungarees / Arbeitslatzhose / Полукомбинезон / Hapükombinezon / Munkaruha - kertész nadrág / Pantaloni de lucru cu pieptar / Pracovní kalhoty s laclem / Pracovné nohavice do záhrady / Delovne hlače / Darbinės kelnės (sodininkams) / Dārziņieces darba bikses / Тöötunked / Градинарски работен панталон / Radne hlače na tregere / Pantalone za rad u vrtu / Φόρμα εργασιών με πρίντες / Pantalón de trabajo tipo mono / Calças de trabalho / Pantalon de travail salopette / Tuinbroek



Ref.	Size	☒	EAN
81-248-XS	XS/46	0/20	5907558451795
81-248-S	S/48	0/20	5907558451801
81-248-M	M/50	0/20	5907558451818
81-248-L	L/52	0/20	5907558451825
81-248-XL	XL/54	0/20	5907558451832
81-248-XXL	XXL/56	0/20	5907558451849
81-248-XXXL	XXXL/58	0/20	5907558451856

Spodnie robocze na szelkach

Working trousers with suspenders / Arbeitslatzhose / Полукомбинезон рабочий / Пюккомбинезон рабочий / Kantáros munkanadrág / Pantaloni de lucru cu bretele / Montérkové kalhoty / Montérky na traky / Delovne hlače / Darbinės kelnės su petnešomis / Darba puskombezonos / Traksidēga tööpüksid / Работни панталони с тиранти / Radne farmer hlače / Radne pantalone sa tregerima / Φόρμα εργασιών πρίντα / Pantalón de trabajo con tirantes / Salopette da lavoro / Jardineiras de trabalho / Pantalon de travail sur bretelles



Ref.	Size	☒	EAN
81-240-S	S/48	0/10	5907558419207
81-240-M	M/50	0/10	5907558419214
81-240-L	L/52	0/10	5907558419221
81-240-LD	L/54	0/10	5907558419238
81-240-XL	XL/56	0/10	5907558419245
81-240-XXL	XXL/58	0/10	5907558419252



Ref.	Size	☒	EAN
81-246-XS	XS/46	0/15	5907558446722
81-246-S	S/48	0/15	5907558446739
81-246-M	M/50	0/15	5907558446746
81-246-L	L/52	0/15	5907558446753
81-246-XL	XL/54	0/15	5907558446760
81-246-XXL	XXL/56	0/15	5907558446777
81-246-XXXL	XXXL/58	0/15	5907558446784

Krótkie spodnie robocze

Shorts / Kurzhose / Шорты / Коротки Штаны / Rövidnadrág / Pantaloni Scurți / Krátasy / Krátke Nohavice / Krátke Hlače / Darbiniai Šortai / Šorti / Lühikesed Püksid / Къси Панталони / Krátke Hlače / Krátke Pantalone / Βερμούδες / Pantalones Cortos / Pantaloncini Corti / Calças Curtas / Culotte / Korte Broek



Ref.	Size	☒	EAN
81-277-XS	XS/46	0/30	5907558472387
81-277-S	S/48	0/30	5907558472394
81-277-M	M/50	0/30	5907558472400
81-277-L	L/52	0/30	5907558472417
81-277-XL	XL/54	0/30	5907558472424
81-277-XXL	XXL/56	0/30	5907558472431
81-277-XXXL	XXXL/58	0/30	5907558472448

Kombinezon roboczy

Working overalls / Arbeitsoverall / Комбинезон рабочий / Комбінезон робочий / Overall / Combinezon de lucru / Pracovní kombinéza / Pracovná kombinéza / Delovni kombinezon / Darbinis kombinezonas / Darba kombinezons / Töökombinesoon / Работен комбинезон / Radni kombinezon / Radni kombinezon / Φόρμα εργασιών / Mono de trabajo / Tuta da lavoro / Macacão de trabalho / Combinaison de travail



COTTON 60%
POLYESTER 37%
ELASTANE 3%

285g/m²

PROFILED

ORIGINAL DESIGN II
Created by NEO

CE

Ref.	Size	☒	EAN
81-258-XS	XS/46	0/15	5907558451863
81-258-S	S/48	0/15	5907558451870
81-258-M	M/50	0/15	5907558451887
81-258-L	L/52	0/15	5907558451894
81-258-XL	XL/54	0/15	5907558451900
81-258-XXL	XXL/56	0/15	5907558451917
81-258-XXXL	XXXL/58	0/15	5907558451924



TUV Rheinland
CERTIFIED

3 STITCH

POLYESTER 65%
COTTON 35%

267g/m²

CE

Ref.	Size	☒	EAN
81-250-S	S/48	0/10	5907558419269
81-250-M	M/50	0/10	5907558419276
81-250-L	L/52	0/10	5907558419283
81-250-LD	L/54	0/10	5907558419290
81-250-XL	XL/56	0/10	5907558419306
81-250-XXL	XXL/58	0/10	5907558419313

Bluza robocza

Working top / Arbeitsshirt / Блуза рабочая / Куртка рабочая / Munkadzseki / Bluza de lucru / Pracovní blůza / Pracovná bunda / Delovna jakna / Darbiniai marškiniai / Darba kreklis / Tööjakk / Работна блуза / Radna bluza / Radna bluza / Μηλούζα εργασιών / Sudadera de trabajo / Giacca da lavoro / Blusão de trabalho / Veste de travail



COTTON 62%
POLYESTER 35%
ELASTANE 3%

270g/m²

CE

Ref.	Size	☒	EAN
81-216-S	S/48	0/20	5907558446593
81-216-M	M/50	0/20	5907558446609
81-216-L	L/52	0/20	5907558446616
81-216-XL	XL/54	0/20	5907558446623
81-216-XXL	XXL/56	0/20	5907558446630
81-216-XXXL	XXXL/58	0/20	5907558446647



COTTON 100%

210g/m²

RIPSTOP

2 in 1

PROFILED

CE

GOOD DESIGN II 2022

ORIGINAL DESIGN II
Created by NEO

Ref.	Size	☒	EAN
81-217-XS	XS/46	0/20	5907558446869
81-217-S	S/48	0/20	5907558446876
81-217-M	M/50	0/20	5907558446883
81-217-L	L/52	0/20	5907558446890
81-217-XL	XL/54	0/20	5907558446906
81-217-XXL	XXL/56	0/20	5907558446913
81-217-XXXL	XXXL/58	0/20	5907558446920

Możliwość połączenia ze spodniami roboczymi 81-227 w kombinezon (elastyczny pas z zamkiem w środku)
Can be matched with jacket 81-227 into a jumpsuit (elastic waistband with a zipper inside)
Можно комбинировать с брюками рабочими 81-227 в комбинезон (пояс на резинке на молнии внутри)



Bluza robocza

Working top / Arbeitsshirt / Блуза рабочая / Куртка рабочая / Munkadzseki / Bluza de lucru / Pracovní blůza / Pracovná bunda / Delovna jakna / Darbiniai marškiniai / Darba kreklis / Tööjakk / Рабочая блуза / Radna bluza / Radna bluza / Μπλούζα εργασίας / Sudadera de trabajo / Giacca da lavoro / Blusaõ de trabalho / Veste de travail

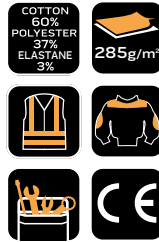

Ref.	Size	☒	EAN
81-218-S	S/48	0/20	5907558451597
81-218-M	M/50	0/20	5907558451603
81-218-L	L/52	0/20	5907558451610
81-218-XL	XL/54	0/20	5907558451627
81-218-XXL	XXL/56	0/20	5907558451634
81-218-XXXL	XXXL/58	0/20	5907558451641



Ref.	Size	☒	EAN
81-210-S	S/48	0/10	5907558419023
81-210-M	M/50	0/10	5907558419030
81-210-L	L/52	0/10	5907558419047
81-210-LD	L/54	0/10	5907558419054
81-210-XL	XL/56	0/10	5907558419061
81-210-XXL	XXL/58	0/10	5907558419078



Bluza polarowa

Polar fleece jacket / Arbeitskittel aus Polarfleece / Блуза из флиса / Мајстерка / Polár munkadzseki / Bluza polar / Fleeceová mikina / Flísová bunda / Jopič iz flisa / Džemperis iš polarinio fliso audinio / Flísa jaka / Fliis / Блузка от флорне / Bluza od polara / Jakna / Μπλούζα φλις / Chaqueta de polar / Giacca in pile / Camisola polar / Polo polaire / Fleece trui



Ref.	Size	☒	EAN
81-506-S	S/48	0/13	5907558441482
81-506-M	M/50	0/13	5907558441499
81-506-L	L/52	0/13	5907558441505
81-506-XL	XL/54	0/13	5907558441512
81-506-XXL	XXL/56	0/13	5907558441529
81-506-XXXL	XXXL/58	0/13	5907558441536



Ref.	Size	☒	EAN
81-507-S	S/48	0/16	5907558498417
81-507-M	M/50	0/16	5907558498400
81-507-L	L/52	0/16	5907558498394
81-507-LD	L/54	0/16	5907558498424
81-507-XL	XL/56	0/16	5907558498431
81-507-XXL	XXL/58	0/16	5907558498448

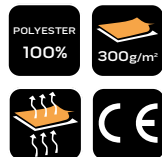

Ref.	Size	☒	EAN
81-500-S	S/48	0/20	5907558419498
81-500-M	M/50	0/20	5907558419504
81-500-L	L/52	0/20	5907558419511
81-500-XL	XL/56	0/20	5907558419528
81-500-XXL	XXL/58	0/20	5907558419535

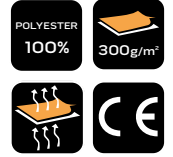

Ref.	Size	☒	EAN
81-501-S	S/48	0/20	5907558429237
81-501-M	M/50	0/20	5907558429244
81-501-L	L/52	0/20	5907558429251
81-501-XL	XL/56	0/20	5907558429268
81-501-XXL	XXL/58	0/20	5907558429275



Bluza polarowa

Polar fleece jacket / Arbeitskittel aus Polarfleece / Блуза из флиса / Мајстерка / Polár munkadzseki / Bluza polar / Fleeceová mikina / Flísová bunda / Jopić iz flisa / Džemperis iš polarinio fliso audinio / Flíša jaka / Flíis / Блузка от флиса / Bluza od polara / Jakna / Μπλούζα φλις / Chaqueta de polar / Giacca in pile / Camisola polar / Polo polaire / Fleece trui



Ref.	Size	☒	EAN
81-503-S	S/48	1/20	5907558482768
81-503-M	M/50	1/20	5907558482775
81-503-L	L/52	1/20	5907558482782
81-503-XL	XL/54	1/20	5907558482799
81-503-XXL	XXL/56	1/20	5907558482805
81-503-XXXL	XXXL/58	1/20	5907558482812



Ref.	Size	☒	EAN
81-502-S	S/48	1/20	5907558482706
81-502-M	M/50	1/20	5907558482713
81-502-L	L/52	1/20	5907558482720
81-502-XL	XL/54	1/20	5907558482737
81-502-XXL	XXL/56	1/20	5907558482744
81-502-XXXL	XXXL/58	1/20	5907558482751



Kurtka softshell

Waterproof, windproof jacket, softshell / Wind- und wasserdichte Softshelljacke / Куртка водо- и ветронепроницаемая, softshell / Випірка з водовідштовхувальної тканини «softshell» / Softshell munkadzseki / Djaca impermeabila, antivânt, softshell / Voděodolná, větruvzdorná, softshellová bunda / Vodoodolná, vetruodolná, softshellová bunda / Jakna, odporna na vodu, veter, softshell / Vėjui ir vandeniui atspari striukė („softshell“) / Ūdensnecaurlaidīga vējjaka, softshell / Softshell vee- ja tuulekindel jope / Блуза от полар / Vodooporna, vjetrooporna jakna softshell / Jakna otporna na vodu, vetar, sa tekim jezgom / Αδιάβροχο μπουφάν για προστασία από τον αέρα / Chaqueta impermeable, antiviento, softshell / Giacca antivento, antipioggia, softshell / Casaco corta vento impermeável softshell / Blouse imperméable pare-brise softshell



Ref.	Size	☒	EAN
81-550-S	S/48	0/10	5907558419542
81-550-M	M/50	0/10	5907558419559
81-550-L	L/52	0/10	5907558419566
81-550-XL	XL/56	0/10	5907558419573
81-550-XXL	XXL/58	0/10	5907558419580



Ref.	Size	☒	EAN
81-551-S	S/48	0/10	5907558427943
81-551-M	M/50	0/10	5907558427950
81-551-L	L/52	0/10	5907558427967
81-551-XL	XL/56	0/10	5907558427974
81-551-XXL	XXL/58	0/10	5907558427981
81-551-XXXL	XXXL/60	0/10	5907558427998

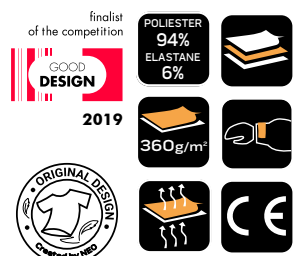

Ref.	Size	☒	EAN
81-558-S	S/48	0/10	5907558434798
81-558-M	M/50	0/10	5907558434804
81-558-L	L/52	0/10	5907558434811
81-558-XL	XL/54	0/10	5907558434828
81-558-XXL	XXL/56	0/10	5907558434835



Bluza robocza

Working top / Arbeitsshirt / Рабочая толстовка / Куртка робоча / Munkadzseki / Bluza de lucru / Pracovní blůza / Pracovná bunda / Delovna jakna / Darbiniai marškiniai / Darba kreklis / Tööjakk / Рабочна блуза / Radna bluza / Radna bluza / Μπλούζα εργαίας / Sudadera de trabajo / Giacca da lavoro / Blusão de trabalho / Veste de travail



Ref.	Size	☒	EAN
81-556-S	S/48	0/10	5907558428124
81-556-M	M/50	0/10	5907558428131
81-556-L	L/52	0/10	5907558428148
81-556-XL	XL/56	0/10	5907558428155
81-556-XXL	XXL/58	0/10	5907558428162
81-556-XXXL	XXXL/60	0/10	5907558428179



Bluza dziana

Knitted sweatshirt / Strickbluse / Тенная блуза / Блуза трикотажна / Kätöitt blúz / Bluz tricotaj / Pletená mikina / Pletená bunda / Pletena bluza / Džemperis / Trikotāžas sporta džemperis / Trikotāžist dressipluus / Телефон за работа при тежки условия / Bluza od pletenine / Pletena bluza / Μπλούζα πλεκτή σπορμού / Sudadera de punto / Felpa in tessuto / Blusão em malha / Blouson tricot / Katoenen trui



Ref.	Size	☒	EAN
81-511-S	S/48	0/20	5907558441420
81-511-M	M/50	0/20	5907558441437
81-511-L	L/52	0/20	5907558441444
81-511-XL	XL/54	0/20	5907558441451
81-511-XXL	XXL/56	0/20	5907558441468
81-511-XXXL	XXXL/58	0/20	5907558441475



Ref.	Size	☒	EAN
81-555-S	S/48	0/10	5907558428063
81-555-M	M/50	0/10	5907558428070
81-555-L	L/52	0/10	5907558428087
81-555-XL	XL/56	0/10	5907558428094
81-555-XXL	XXL/58	0/10	5907558428100
81-555-XXXL	XXL/60	0/10	5907558428117



T-shirt

T-shirt / T-Shirt / Футболка сигнальная / Футболка / Póló / T-shirt / Tričko / Tričko / Majica / Apatiniai marškinėliai - T / T-crekls / T-särk / Тушэрт / T-shirt / Majica kratkih rukava / Κομπομένη μπλούζα / Camiseta / Maglietta / Camisola / T-shirt / T-shirt



Ref.	Size	☒	EAN
81-609-S	S/48	1/25	5907558470352
81-609-M	M/50	1/25	5907558470369
81-609-L	L/52	1/25	5907558470376
81-609-XL	XL/54	1/25	5907558470383
81-609-XXL	XXL/56	1/25	5907558470390
81-609-XXXL	XXXL/58	1/25	5907558470406



Ref.	Size	☒	EAN
81-640-M	M/50	0/50	5907558483420
81-640-L	L/52	0/50	5907558483437
81-640-XL	XL/54	0/50	5907558483444
81-640-XXL	XXL/56	0/50	5907558483451
81-640-XXXL	XXXL/58	0/50	5907558483468



Ref.	Size	☒	EAN
81-642-M	M/50	0/50	5907558483529
81-642-L	L/52	0/50	5907558483536
81-642-XL	XL/54	0/50	5907558483543
81-642-XXL	XXL/56	0/50	5907558483550
81-642-XXXL	XXXL/58	0/50	5907558483567



Ref.	Size	☒	EAN
81-641-M	M/50	0/50	5907558483475
81-641-L	L/52	0/50	5907558483482
81-641-XL	XL/54	0/50	5907558483499
81-641-XXL	XXL/56	0/50	5907558483505
81-641-XXXL	XXXL/58	0/50	5907558483512



T-shirt

T-shirt / T-Shirt / Футболка сигнальная / Футболка / Póló / T-shirt / Tričko / Tričko / Majica / Apatiniai marškinėliai - T / T-kreklis / T-särk / Тушэpm / T-shirt / Majica kratkih rukava / Κομποάνκη μπλούζα / Camiseta / Maglietta / Camisola / T-shirt / T-shirt



ORIGINAL DESIGN
Created by NEO

COTTON 100%

180g/m²

CE

PE-LD

Ref.	Size	☒	EAN
81-643-M	M/50	0/50	5907558483574
81-643-L	L/52	0/50	5907558483581
81-643-XL	XL/54	0/50	5907558483598
81-643-XXL	XXL/56	0/50	5907558483604
81-643-XXXL	XXXL/58	0/50	5907558483611



COTTON 100%

CE

ORIGINAL DESIGN
Created by NEO

Ref.	Size	☒	EAN
81-680-S	S/48	0/50	5907558475531
81-680-M	M/50	0/50	5907558475548
81-680-L	L/52	0/50	5907558475555
81-680-XL	XL/54	0/50	5907558475562
81-680-XXL	XXL/56	0/50	5907558475579
81-680-XXXL	XXXL/58	0/50	5907558475586



COTTON 100%

180g/m²

CE

PE-LD

Ref.	Size	☒	EAN
81-610-S	S/48	0/50	5907558432022
81-610-M	M/50	0/50	5907558432039
81-610-L	L/52	0/50	5907558432046
81-610-XL	XL/54	0/50	5907558432053
81-610-XXL	XXL/56	0/50	5907558432060



COTTON 100%

CE

ORIGINAL DESIGN
Created by NEO

Ref.	Size	☒	EAN
81-681-S	S/48	0/50	5907558475593
81-681-M	M/50	0/50	5907558475609
81-681-L	L/52	0/50	5907558475616
81-681-XL	XL/54	0/50	5907558475623
81-681-XXL	XXL/56	0/50	5907558475630
81-681-XXXL	XXXL/58	0/50	5907558475647



COTTON 100%

180g/m²

CE

PE-LD

Ref.	Size	☒	EAN
81-647-S	S/48	0/50	5907558483000
81-647-M	M/50	0/50	5907558483017
81-647-L	L/52	0/50	5907558483024
81-647-XL	XL/54	0/50	5907558483031
81-647-XXL	XXL/56	0/50	5907558483048
81-647-XXXL	XXXL/58	0/50	5907558483055



COTTON 100%

CE

ORIGINAL DESIGN
Created by NEO

Ref.	Size	☒	EAN
81-682-S	S/48	0/50	5907558475654
81-682-M	M/50	0/50	5907558475661
81-682-L	L/52	0/50	5907558475668
81-682-XL	XL/54	0/50	5907558475675
81-682-XXL	XXL/56	0/50	5907558475682
81-682-XXXL	XXXL/58	0/50	5907558475699



COTTON 100%

180g/m²

CE

PE-LD

Ref.	Size	☒	EAN
81-648-S	S/48	0/50	5907558482942
81-648-M	M/50	0/50	5907558482959
81-648-L	L/52	0/50	5907558482966
81-648-XL	XL/54	0/50	5907558482973
81-648-XXL	XXL/56	0/50	5907558482980
81-648-XXXL	XXXL/58	0/50	5907558482997



T-shirt

T-shirt / T-Shirt / Футболка сигнальная / Футболка / Póló / T-shirt / Tričko / Tričko / Majica / Apatiniai marškinėliai - T / T-kreklis / T-särk / Тушэрт / T-shirt / Majica kratkih rukava / Κοτομάνικη μπλούζα / Camiseta / Maglietta / Camisola / T-shirt / T-shirt

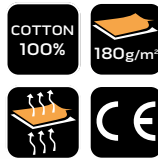

Ref.	Size	☒	EAN
81-615-S	S/48	0/50	5907558435344
81-615-M	M/50	0/50	5907558435351
81-615-L	L/52	0/50	5907558435368
81-615-XL	XL/54	0/50	5907558435375
81-615-XXL	XXL/56	0/50	5907558435382

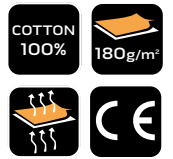

Ref.	Size	☒	EAN
81-649-S	S/48	0/50	5907558482881
81-649-M	M/50	0/50	5907558482898
81-649-L	L/52	0/50	5907558482904
81-649-XL	XL/54	0/50	5907558482911
81-649-XXL	XXL/56	0/50	5907558482928
81-649-XXXL	XXXL/58	0/50	5907558482935

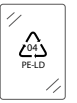

Koszulka polo

Polo shirt / Polo-Shirt / Футболка-поло / Сорочка-поло / Pólóing / Camasa din tesatura / Tričko polo / Polokošeta / Majica z ovratnikom / Marškiniai „Polo“ / Polo kreklis / Polosärk / Блузка полф / Polo majica / Polo majica / Κοτομάνικη μπλούζα πόλο / Camiseta polo Polo / Camisa polo / Chemise polo / Polo shirt



Ref.	Size	☒	EAN
81-606-S	S/48	0/40	5907558439809
81-606-M	M/50	0/40	5907558439816
81-606-L	L/52	0/40	5907558439823
81-606-XL	XL/54	0/40	5907558439830
81-606-XXL	XXL/56	0/40	5907558439847
81-606-XXXL	XXXL/58	0/40	5907558439854



Ref.	Size	☒	EAN
81-659-S	S/48	0/25	5907558467918
81-659-M	M/50	0/25	5907558467925
81-659-L	L/52	0/25	5907558467932
81-659-XL	XL/54	0/25	5907558467949
81-659-XXL	XXL/56	0/25	5907558467956
81-659-XXXL	XXXL/58	0/25	5907558467963



Koszulka z długim rękawem

Longsleeve / Сорочка з довшим рукавом / Cămașă cu mânecă lungă / Hosszú ujjú ing / Maglietta a manica lunga / Langarm-Shirt / Футболка с длинными рукавами / Tričko s dlouhým rukávem / Tričko s dlhým rukávom / Majica dugih rukava / Marškiniai su ilgomis rankovėmis / Kreklis ar garām piedurknēm / Srajca z dolgimi rokavi / Блузка с дълъг ръкав / Košulja sa dugim rukavima / Μπλουζάκι μακρομάνικο / Camisa de manga larga / Pikkade varrukatega särk



Ref.	Size	☒	EAN
81-690-S	S/48	0/50	5907558475357
81-690-M	M/50	0/50	5907558475364
81-690-L	L/52	0/50	5907558475371
81-690-XL	XL/54	0/50	5907558475388
81-690-XXL	XXL/56	0/50	5907558475395
81-690-XXXL	XXXL/58	0/50	5907558475401



Ref.	Size	☒	EAN
81-691-S	S/48	0/50	5907558475418
81-691-M	M/50	0/50	5907558475425
81-691-L	L/52	0/50	5907558475432
81-691-XL	XL/54	0/50	5907558475449
81-691-XXL	XXL/56	0/50	5907558475456
81-691-XXXL	XXXL/58	0/50	5907558475463



Ref.	Size	☒	EAN
81-692-S	S/48	0/50	5907558475470
81-692-M	M/50	0/50	5907558475487
81-692-L	L/52	0/50	5907558475494
81-692-XL	XL/54	0/50	5907558475500
81-692-XXL	XXL/56	0/50	5907558475517
81-692-XXXL	XXXL/58	0/50	5907558475524

Bezrękawnik roboczy

Work body warmer / Arbeitsweste / Жилет рабочий / Безрукавка рабочая / Mellény fényvisszaverő / Vesta de lucru / Pracovní vesta / Pracovní vesta / Delovni brezrokavnik / Darbinė liemenė / Darba jaka bez piedurknēm / Töövest / Рабочий елек / Radni prsluk / Radnički prsluk / Γιλέκο εργασιός / Chaleco de trabajo / Gilet da lavoro doppio uso / Blusa de trabalho sem mangas / Gilet de travail

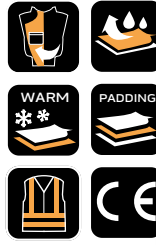

Ref.	Size	☒	EAN
81-534-S	S/48	0/10	5907558441789
81-534-M	M/50	0/10	5907558441796
81-534-L	L/52	0/10	5907558441802
81-534-XL	XL/54	0/10	5907558441819
81-534-XXL	XXL/56	0/10	5907558441826
81-534-XXXL	XXXL/58	0/10	5907558441833



Ref.	Size	☒	EAN
81-530-S	S/48	0/20	5907558427011
81-530-M	M/50	0/20	5907558427028
81-530-L	L/52	0/20	5907558427035
81-530-XL	XL/56	0/20	5907558427042
81-530-XXL	XXL/58	0/20	5907558427059

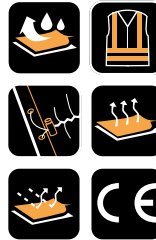

Ref.	Size	☒	EAN
81-532-S	S/48	0/20	5907558427882
81-532-M	M/50	0/20	5907558427899
81-532-L	L/52	0/20	5907558427905
81-532-XL	XL/56	0/20	5907558427912
81-532-XXL	XXL/58	0/20	5907558427929
81-532-XXXL	XXXL/60	0/20	5907558427936

Koszula flanelowa

Flannel shirt / Flannelhemd / Фланелевая рубашка / Сорочка фланелева / Flanel ing / Cămașă de flanelă / Flanelová košile / Flanelová košela / Flanelasta srajca / Flaneliniai marškiniai / Flanela kreklis / Flanelšārk / Flanelena ruza / Košulja od flanela / Flanelaska košulja / Φανελένιο πουκάμισο / Camisa de franela / Camicia di flanela / Camisa de flanela / Chemise en flanelle

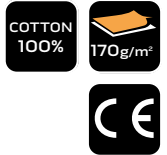

Ref.	Size	☒	EAN
81-547-S	S/48	0/36	5906692015351
81-547-M	M/50	0/36	5906692015344
81-547-L	L/52	0/36	5906692015337
81-547-XL	XL/56	0/36	5906692015368
81-547-XXL	XXL/58	0/36	5906692015375
81-547-XXXL	XXXL/60	0/36	5906692015382

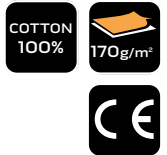

Ref.	Size	☒	EAN
81-545-S	S/48	1/36	5907558484366
81-545-M	M/50	1/36	5907558484373
81-545-L	L/52	1/36	5907558484380
81-545-XL	XL/56	1/36	5907558484397
81-545-XXL	XXL/58	1/36	5907558484403
81-545-XXXL	XXXL/60	1/36	5907558484410

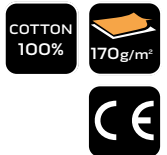

Ref.	Size	☒	EAN
81-546-S	S/48	1/36	5907558484427
81-546-M	M/50	1/36	5907558484434
81-546-L	L/52	1/36	5907558484441
81-546-XL	XL/56	1/36	5907558484458
81-546-XXL	XXL/58	1/36	5907558484465
81-546-XXXL	XXXL/60	1/36	5907558484472



Koszula flanelowa

Flannel shirt / Flannelhemd / Фланелевая рубашка / Сорочка фланелева / Flaneling / Cămașă de flanelă / Flanelová košile / Flanelová košela / Flanelasta srajca / Flaneliniai marškiniai / Flanela kreklis / Flannelsärk / Фланелена риза / Košulja od flanela / Flaneliska košulja / Φανελένιο πουκάμισο / Camisa de franela / Camicia di flanela / Camisa de flanela / Chemise en flanelle



COTTON
100%



Ref.	Size	☒	EAN
81-540-S	S/48	0/36	5907558432244
81-540-M	M/50	0/36	5907558432251
81-540-L	L/52	0/36	5907558432268
81-540-XL	XL/54	0/36	5907558432275
81-540-XXL	XXL/56	0/36	5907558432282



COTTON
100%



Ref.	Size	☒	EAN
81-541-S	S/48	0/36	5907558432299
81-541-M	M/50	0/36	5907558432305
81-541-L	L/52	0/36	5907558432312
81-541-XL	XL/54	0/36	5907558432329
81-541-XXL	XXL/56	0/36	5907558432336



Koszula robocza

Work shirt / Arbeitshemd / Рабочая рубашка / Рбочна сорочка / Munka ing / Cămașă de lucru / Pracovní košile / Pracovná košela / Delovna majica / Darbo marškiniai / Darba kreklis / Работна риза / Radna košulja / Радна мајица / εργασία πουκάμισο / Camisa de trabajo / Camicia da lavoro / Camisa de trabalho / Chemise de travail / Werk shirt



COTTON
100%

140g/m²



Ref.	Size	☒	EAN
81-549-S	S/48	0/30	5907558439625
81-549-M	M/50	0/30	5907558439632
81-549-L	L/52	0/30	5907558439649
81-549-XL	XL/54	0/30	5907558439656
81-549-XXL	XXL/56	0/30	5907558439663
81-549-XXXL	XXXL/58	0/30	5907558439670



Bokserki

Boxers / Boxer / Боксеры / Боксеру / Bokszolók / Boxeri / Boxeři / Boxerky / Boksarice / Boksininkai / Bokseri / Poksijad / Боксерни / Boksačice / Боксеру / Μηξερ / Boxeadores / Pugili / Pugilistas / Boxeurs / Bokser



COTTON
95%
ELASTANE
5%

180g/m²

x3



Ref.	Size	☒	EAN
81-679-M	M/50	0/50	5907558498769
81-679-L	L/52	0/50	5907558498752
81-679-XL	XL/56	0/50	5907558498776
81-679-XXL	XXL/58	0/50	5907558498783

Spodnie robocze

Working trousers / Arbeitshosen / Брюки рабочие / Штаны рабочие / Munkaruha nadrág / Pantaloni de lucru / Pracovní kalhoty / Pracovné nohavice / Delovne hlače / Darbinės kelinės / Darba bikses / Τσούψκιδ / Работни панталони / Radne hlače / Rande pantalone / Παντελόν εργασίας / Pantalón de trabajo / Pantaloni da lavoro / Calças de trabalho / Pantalon de travail / Werkbroek



COTTON 79%
VISCOSE 8%
POLYESTER 13%

320g/m²



Ref.	Size	⊠	EAN
81-280-S	S/48	0/28	5907558498233
81-280-M	M/50	0/28	5907558498226
81-280-L	L/52	0/28	5907558498219
81-280-XL	XL/54	0/28	5907558498240
81-280-XXL	XXL/56	0/28	5907558498257
81-280-XXXL	XXXL/58	0/28	5907558498264



COTTON 57%
POLYESTER 39%
ELASTANE 4%

320g/m²



Ref.	Size	⊠	EAN
81-282-S	S/48	0/24	5907558498295
81-282-M	M/50	0/24	5907558498288
81-282-L	L/52	0/24	5907558498271
81-282-XL	XL/54	0/24	5907558498301
81-282-XXL	XXL/56	0/24	5907558498318
81-282-XXXL	XXXL/58	0/24	5907558498325



COTTON 57%
POLYESTER 39%
ELASTANE 4%

320g/m²



Ref.	Size	⊠	EAN
81-283-S	S/48	0/20	5907558498356
81-283-M	M/50	0/20	5907558498349
81-283-L	L/52	0/20	5907558498332
81-283-XL	XL/54	0/20	5907558498363
81-283-XXL	XXL/56	0/20	5907558498370
81-283-XXXL	XXXL/58	0/20	5907558498387



Bluza robocza

Working top / Arbeitsshirt / Рабочая толстовка / Куртка рабочая / Munkadzseki / Bluza de lucru / Pracovní blůza / Pracovná bunda / Delovna jakna / Darbiniai marškiniai / Darba krekls / Τσούψκ / Рабочая блуза / Radna bluza / Μπλούζα εργασίας / Sudadera de trabajo / Giacca da lavoro / Blusão de trabalho / Veste de travail



COTTON 57%
POLYESTER 33%
ELASTANE 4%

320g/m²



Ref.	Size	⊠	EAN
81-651-S	S/48	0/26	5907558498653
81-651-M	M/50	0/26	5907558498646
81-651-L	L/52	0/26	5907558498639
81-651-XL	XL/54	0/26	5907558498660
81-651-XXL	XXL/56	0/26	5907558498677
81-651-XXXL	XXXL/58	0/26	5907558498684



COTTON 79%
VISCOSE 8%
POLYESTER 13%

320g/m²



Ref.	Size	⊠	EAN
81-650-S	S/48	0/32	5907558498592
81-650-M	M/50	0/32	5907558498585
81-650-L	L/52	0/32	5907558498578
81-650-XL	XL/54	0/32	5907558498608
81-650-XXL	XXL/56	0/32	5907558498615
81-650-XXXL	XXXL/58	0/32	5907558498622



POLYESTER 60%
RAYON 40%

250g/m²



Ref.	Size	⊠	EAN
81-513-S	S/48	0/30	5907558498479
81-513-M	M/50	0/30	5907558498462
81-513-L	L/52	0/30	5907558498455
81-513-XL	XL/54	0/30	5907558498486
81-513-XXL	XXL/56	0/30	5907558498493
81-513-XXXL	XXXL/58	0/30	5907558498509



COTTON 57%
POLYESTER 39%
ELASTANE 4%

320g/m²



Ref.	Size	⊠	EAN
81-514-S	S/48	0/22	5907558498530
81-514-M	M/50	0/22	5907558498523
81-514-L	L/52	0/22	5907558498516
81-514-XL	XL/54	0/22	5907558498547
81-514-XXL	XXL/56	0/22	5907558498554
81-514-XXXL	XXXL/58	0/22	5907558498561



Koszulka termoaktywna

Thermal long sleeve / Thermo-Funktionsunterwäsche Hemd langarm / Термоактивная блуза / Футболка з довгим рукавом термоактивна / Thermo alältözet felső / Cămașă termoactivă / Termoaktivní tričko / Termo tričko / Termo majica / Termo marškinėliai / Termoveļas kreklis / Termoaktiivne alussärk / Термоактивна блуза / Termoaktivna majica / Термоактивна кошуља / Ισοθερμική μπλούζα / Camiseta termoactiva / Maglia termica / Camisola térmica / Chemise thermoactive / Thermoactive shirt



POLYAMIDE
63%
POLYESTER
32%
ELASTANE
5%



Ref.	Size	☒	EAN
81-660-S/M	S/48 / M/50	0/60	5907558431964
81-660-L/XL	L/52 / XL/54	0/60	5907558431971
81-660-XXL/XXXL	XXL/56 / XXXL/58	0/60	5907558431988



POLYESTER
100%



WARM



Ref.	Size	☒	EAN
81-661-S/M	S/48 / M/50	0/50	5907558448900
81-661-L/XL	L/52 / XL/54	0/50	5907558448917
81-661-XXL/XXXL	XXL/56 / XXXL/58	0/50	5907558431971



COOLMAX
60%
NYLON
32%
ELASTANE
8%



Ref.	Size	☒	EAN
81-662-S/M	S/48 / M/50	0/60	5907558463392
81-662-L/XL	L/52 / XL/54	0/60	5907558463408
81-662-XXL/XXXL	XXL/56 / XXXL/58	0/60	5907558463415



BAMBOO CARBON
60%
NYLON
32%
ELASTANE
8%



ODOUR STOP



Ref.	Size	☒	EAN
81-663-S/M	S/48 / M/50	0/60	5907558463422
81-663-L/XL	L/52 / XL/54	0/60	5907558463439
81-663-XXL/XXXL	XXL/56 / XXXL/58	0/60	5907558463446

Kalesony termoaktywne

Thermal leggings / Thermo-Funktionsunterwäsche Hose / Термоактивные кальсоны / Кальсоны термоактивни / Thermo alältözet alsó / Izmene thermoactive / Termoaktivní kalhoty (spodky) / Termo spodnje nohavice / Termo spodnje hlače / Termo kelnès / Termoveļas bikses / Termoaktiivsed pīkad aluspiiksid / Термоактивен клин / Termoaktiivne duge gaće / Termoaktiivne pantalone / Ισοθερμικό κολόν / Mallas termoactivas / Calzamaglia termica / Calças justas térmicas / Caleçon thermoactif / Thermoactive broek



POLYAMIDE
63%
POLYESTER
32%
ELASTANE
5%

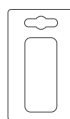

Ref.	Size	☒	EAN
81-670-S/M	S/48 / M/50	0/60	5907558431995
81-670-L/XL	L/52 / XL/54	0/60	5907558432008
81-670-XXL/XXXL	XXL/56 / XXXL/58	0/60	5907558432015



POLYESTER
100%



WARM

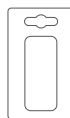

Ref.	Size	☒	EAN
81-671-S/M	S/48 / M/50	0/50	5907558448931
81-671-L/XL	L/52 / XL/54	0/50	5907558448948
81-671-XXL/XXXL	XXL/56 / XXXL/58	0/50	5907558448955



COOLMAX
60%
NYLON
32%
ELASTANE
8%

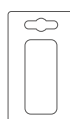

Ref.	Size	☒	EAN
81-672-S/M	S/48 / M/50	0/60	5907558463453
81-672-L/XL	L/52 / XL/54	0/60	5907558463460
81-672-XXL/XXXL	XXL/56 / XXXL/58	0/60	5907558463477



BAMBOO CARBON
60%
NYLON
32%
ELASTANE
8%

ODOUR STOP

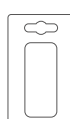

Ref.	Size	☒	EAN
81-673-S/M	S/48 / M/50	0/60	5907558463484
81-673-L/XL	L/52 / XL/54	0/60	5907558463491
81-673-XXL/XXXL	XXL/56 / XXXL/58	0/60	5907558463507

Czapka z latarką

Cap with flashlight / Mütze mit Stirnlampe / Βεΐσβολνα с фонариком / Шапка з ліхтарем / Sapka lámpával / Čičiulă cu lanternă / Čepice s baterkou / Čiapka s baterkou / Kapa z lučko / Kepurè su žibintuveliu / Cepure ar lukturì / Lambiga müts / Шапка с фенерче / Kapa sa svijetiljkom / Kapa s lampom / Καπέλο τύπου τζοκέυ με φακό / Gorra con linterna / Cappello con torcia elettrica / Gorra con lanterna / Casquette avec torche



81-632



81-621



81-631



81-630



Ref.	⊞	EAN
81-630	0/90	5907558460179
81-631	0/90	5907558460186
81-632	0/90	5907558460193
81-621	0/90	5907558428308

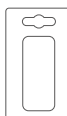

Ref.	⊞	EAN
81-627	1/100	5906692014606

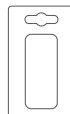

Póľbuty robocze

Safety shoes / Arbeitshalschuhe / Полуботинки рабочие / Півчеревики робочі / Munkaciőő / Pantofi de lucru / Pracovní obuv / Pracovné paltopánky / Nizki delovni čevlji / Darbo pusbačiai / Darba puszabaki / Töökingad / Работни обувки ниски (половинки) / Radne cipele / Poluduboke radne cipele / Ημιμποτα εργασις / Botas de seguridad / Scarpa da lavoro / Sapatos de trabalho / Souliers de sécurité / Werkschoenen



Ref.	Size	Size [cm]	⊞	EAN
82-155-39	39	26	0/10	5907558442908
82-155-40	40	26.7	0/10	5907558442915
82-155-41	41	27.3	0/10	5907558442922
82-155-42	42	28	0/10	5907558442939
82-155-43	43	28.7	0/10	5907558442946
82-155-44	44	29.3	0/10	5907558442953
82-155-45	45	30	0/10	5907558442960
82-155-46	46	30.7	0/10	5907558442977
82-155-47	47	31.3	0/10	5907558442984

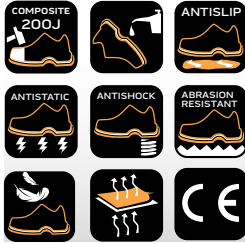

Ref.	Size	Size [cm]	⊞	EAN
82-090	39	26	0/10	5907558426748
82-091	40	26.7	0/10	5907558426755
82-092	41	27.3	0/10	5907558426762
82-093	42	28	0/10	5907558426779
82-094	43	28.7	0/10	5907558426786
82-095	44	29.3	0/10	5907558426793
82-096	45	30	0/10	5907558426809
82-097	46	30.7	0/10	5907558426816
82-098	47	31.3	0/10	5907558426823



Ref.	Size	Size [cm]	⊞	EAN
82-010	39	26	0/10	5907558412604
82-011	40	26.7	0/10	5907558414530
82-012	41	27.3	0/10	5907558414974
82-013	42	28	0/10	5907558414981
82-014	43	28.7	0/10	5907558414998
82-015	44	29.3	0/10	5907558415001
82-016	45	30	0/10	5907558415018
82-017	46	30.7	0/10	5907558415025
82-018	47	31.3	0/10	5907558421002



Ref.	Size	Size [cm]	⊞	EAN
82-160-39	39	26	0/10	5907558483970
82-160-40	40	26.7	0/10	5907558483987
82-160-41	41	27.3	0/10	5907558483994
82-160-42	42	28	0/10	5907558484007
82-160-43	43	28.7	0/10	5907558484014
82-160-44	44	29.3	0/10	5907558484021
82-160-45	45	30	0/10	5907558484038
82-160-46	46	30.7	0/10	5907558484045
82-160-47	47	31.3	0/10	5907558484052

Półbuty robocze

Safety shoes / Arbeitshalbschuhe / Полуботинки рабочие / Півчеревики робочі / Мункасирб / Pantofi de lucru / Pracovní obuv / Pracovné poltopánky / Nizki delovni čevlji / Darbo pusbačiai / Darba puszabaki / Töökingad / Работни обувки ниски (половинки) / Radne cipele / Poluduboke radne cipele / Ημιγυατα εργασις / Botas de seguridad / Scarpa da lavoro / Sapatos de trabalho / Souliers de sécurité / Werkschoenen



Ref.	Size	Size [cm]	☒	EAN
82-100	39	26	0/10	5907558426830
82-101	40	26.7	0/10	5907558426847
82-102	41	27.3	0/10	5907558426854
82-103	42	28	0/10	5907558426861
82-104	43	28.7	0/10	5907558426878
82-105	44	29.3	0/10	5907558426885
82-106	45	30	0/10	5907558426892
82-107	46	30.7	0/10	5907558426908
82-108	47	31.3	0/10	5907558426915



Ref.	Size	Size [cm]	☒	EAN
82-110	39	26	0/10	5907558426922
82-111	40	26.7	0/10	5907558426939
82-112	41	27.3	0/10	5907558426946
82-113	42	28	0/10	5907558426953
82-114	43	28.7	0/10	5907558426960
82-115	44	29.3	0/10	5907558426977
82-116	45	30	0/10	5907558426984
82-117	46	30.7	0/10	5907558426991
82-118	47	31.3	0/10	5907558427004



Ref.	Size	Size [cm]	☒	EAN
82-710	39	26	0/10	5907558430165
82-711	40	26.7	0/10	5907558430172
82-712	41	27.3	0/10	5907558430189
82-713	42	28	0/10	5907558430196
82-714	43	28.7	0/10	5907558430202
82-715	44	29.3	0/10	5907558430219
82-716	45	30	0/10	5907558430226
82-717	46	30.7	0/10	5907558430233
82-718	47	31.3	0/10	5907558430240



Ref.	Size	Size [cm]	☒	EAN
82-700	39	26	0/10	5907558430073
82-701	40	26.7	0/10	5907558430080
82-702	41	27.3	0/10	5907558430097
82-703	42	28	0/10	5907558430103
82-704	43	28.7	0/10	5907558430110
82-705	44	29.3	0/10	5907558430127
82-706	45	30	0/10	5907558430134
82-707	46	30.7	0/10	5907558430141
82-708	47	31.3	0/10	5907558430158



Ref.	Size	Size [cm]	☒	EAN
82-161-39	39	26	0/10	5907558499094
82-161-40	40	26.7	0/10	5907558499100
82-161-41	41	27.3	0/10	5907558499117
82-161-42	42	28	0/10	5907558499124
82-161-43	43	28.7	0/10	5907558499131
82-161-44	44	29.3	0/10	5907558499148
82-161-45	45	30	0/10	5907558499155
82-161-46	46	30.7	0/10	5907558499162
82-161-47	47	31.3	0/10	5907558499179



Ref.	Size	Size [cm]	☒	EAN
82-163-39	39	26	0/10	5907558499278
82-163-40	40	26.7	0/10	5907558499285
82-163-41	41	27.3	0/10	5907558499292
82-163-42	42	28	0/10	5907558499308
82-163-43	43	28.7	0/10	5907558499315
82-163-44	44	29.3	0/10	5907558499322
82-163-45	45	30	0/10	5907558499339
82-163-46	46	30.7	0/10	5907558499346
82-163-47	47	31.3	0/10	5907558499353

Póľubty robocze

Safety shoes / Arbeitshalbschuhe / Полуботинки рабочие / Півчеревики робочі / Munkacipő / Pantofi de lucru / Pracovní obuv / Pracovné poltopánky / Nizki delovni čevlji / Darbo pusbačiai / Darba puszabaki / Töökingad / Работни обувки ниски (половинки) / Radne cipele / Poluduboke radne cipele / Ημιμποτα εργαίας / Botas de seguridad / Scarpa da lavoro / Sapatos de trabalho / Souliers de sécurité / Werkschoenen

02
SR FO



Ref.	Size	Size [cm]	☒	EAN
82-741-39	39	26	0/10	5907558499186
82-741-40	40	26.7	0/10	5907558499193
82-741-41	41	27.3	0/10	5907558499209
82-741-42	42	28	0/10	5907558499216
82-741-43	43	28.7	0/10	5907558499223
82-741-44	44	29.3	0/10	5907558499230
82-741-45	45	30	0/10	5907558499247
82-741-46	46	30.7	0/10	5907558499254
82-741-47	47	31.3	0/10	5907558499261

S1
FO



Ref.	Size	Size [cm]	☒	EAN
82-162-39	39	26	0/10	5907558426137
82-162-40	40	26.7	0/10	5907558426120
82-162-41	41	27.3	0/10	5907558426151
82-162-42	42	28	0/10	5907558426168
82-162-43	43	28.7	0/10	5907558426328
82-162-44	44	29.3	0/10	5907558426335
82-162-45	45	30	0/10	5907558426342
82-162-46	46	30.7	0/10	5907558426359
82-162-47	47	31.3	0/10	5907558426366

Sandaly robocze

Working sandals / Arbeitssandale / Рабочие сандалии / Sandale de lucru / Робочі стандарти / Munkaszandál / Pracovní sandály / Pracovné sandále / Delovni sandali / Darbo sandalai / Darba sandales / Töösaandlid / Работни сандали / Radne sandale / Radne sandale / Σανδάλια εργαίας / Sandalias de trabajo / Sandali da lavoro / Sandálias de proteção / Sandales de travail / Werksandalen

S1P
SR



Ref.	Size	Size [cm]	☒	EAN
82-089-39	39	26	0/10	5907558426229
82-089-40	40	26.7	0/10	5907558426250
82-089-41	41	27.3	0/10	5907558426267
82-089-42	42	28	0/10	5907558426298
82-089-43	43	28.7	0/10	5907558426281
82-089-44	44	29.3	0/10	5907558426274
82-089-45	45	30	0/10	5907558426304
82-089-46	46	30.7	0/10	5907558426311
82-089-47	47	31.3	0/10	5907558426144

OB
SRA



Ref.	Size	Size [cm]	☒	EAN
82-720	39	26	0/10	5907558430257
82-721	40	26.7	0/10	5907558430264
82-722	41	27.3	0/10	5907558430271
82-723	42	28	0/10	5907558430288
82-724	43	28.7	0/10	5907558430295
82-725	44	29.3	0/10	5907558430301
82-726	45	30	0/10	5907558430318
82-727	46	30.7	0/10	5907558430325
82-728	47	31.3	0/10	5907558430332

Trzewiki robocze

Safety boots / Arbeitsschuhe / Ботинки рабочие / Черевки робочі / Munkabakancs / Boscanci de lucru / Kotniková pracovní obuv / Pracovné topánky / Visoki delovni čevlji / Darbo batai / Darba zăbaki / Töösaapad / Работни обувки високи / Radne visoke cipele / Radne cipele / Μποτάκια εργαίας / Botas de seguridad altas / Scarpa alta da lavoro / Botas de trabalho / Chaussures de sécurité / Hoge werkschoenen

02
SR FO



Ref.	Size	Size [cm]	☒	EAN
82-751-39	39	26	0/10	5907558499001
82-751-40	40	26.7	0/10	5907558499018
82-751-41	41	27.3	0/10	5907558499025
82-751-42	42	28	0/10	5907558499032
82-751-43	43	28.7	0/10	5907558499049
82-751-44	44	29.3	0/10	5907558499056
82-751-45	45	30	0/10	5907558499063
82-751-46	46	30.7	0/10	5907558499070
82-751-47	47	31.3	0/10	5907558499087

S3
SRC



Ref.	Size	Size [cm]	☒	EAN
82-120	39	26	0/10	5907558428698
82-121	40	26.7	0/10	5907558428704
82-122	41	27.3	0/10	5907558428711
82-123	42	28	0/10	5907558428728
82-124	43	28.7	0/10	5907558428735
82-125	44	29.3	0/10	5907558428742
82-126	45	30	0/10	5907558428759
82-127	46	30.7	0/10	5907558428766
82-128	47	31.3	0/10	5907558428773

Trzewiki robocze

Safety boots / Arbeitsschuhe / Ботинки робочие / Черевуки робочі / Munkabakancs / Vocanci de lucru / Kotniková pracovní obuv / Pracovné topánky / Visoki delovni čevlji / Darba batai / Darba zăbaki / Τόσσαραπ / Работни обувки високи / Radne visoke cipele / Radne cipele / Μπατάκια εργασίας / Botas de seguridad altas / Scarpa alta da lavoro / Botas de trabalho / Chaussures de sécurité / Hoge werkschoenen



Ref.	Size	Size [cm]	☒	EAN
82-165-39	39	26	0/10	5907558484069
82-165-40	40	26.7	0/10	5907558484076
82-165-41	41	27.3	0/10	5907558484083
82-165-42	42	28	0/10	5907558484090
82-165-43	43	28.7	0/10	5907558484106
82-165-44	44	29.3	0/10	5907558484113
82-165-45	45	30	0/10	5907558484120
82-165-46	46	30.7	0/10	5907558484137
82-165-47	47	31.3	0/10	5907558484144



Ref.	Size	Size [cm]	☒	EAN
82-166-39	39	26	0/10	5907558484151
82-166-40	40	26.7	0/10	5907558484168
82-166-41	41	27.3	0/10	5907558484175
82-166-42	42	28	0/10	5907558484182
82-166-43	43	28.7	0/10	5907558484199
82-166-44	44	29.3	0/10	5907558484205
82-166-45	45	30	0/10	5907558484212
82-166-46	46	30.7	0/10	5907558484229
82-166-47	47	31.3	0/10	5907558484236



Ref.	Size	Size [cm]	☒	EAN
82-020	39	26	0/10	5907558415032
82-021	40	26.7	0/10	5907558415049
82-022	41	27.3	0/10	5907558415056
82-023	42	28	0/10	5907558415063
82-024	43	28.7	0/10	5907558415070
82-025	44	29.3	0/10	5907558415087
82-026	45	30	0/10	5907558415094
82-027	46	30.7	0/10	5907558415100
82-028	47	31.3	0/10	5907558421019

Wkładka do butów

Shoe insert / Einlegesohle / Стельна для обуви / Устілка до черевуки / Talpabeté / Branț de încălțăminte / Vložka do obuvi / Vložka do topánok / Vložek za čevlje / Batų vidpadis / Aravu ielktnis / Sisetallad / Вложка за обуви / Uložak za cipele / Uložak za obući / Πάτος πανουσιών / Plantilla para zapatos / Soletta per scarpe / Palmilha / Insert de chaussure / Inlegzool



Ref.	size [mm]	☒	EAN
82-315	36-40	1/200	5907558495492
82-316	41-47	1/200	5907558495508

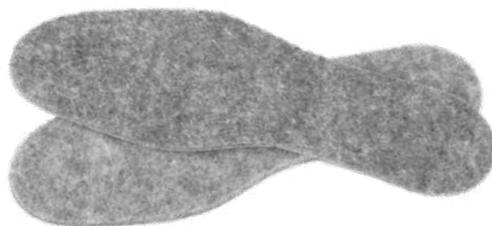

Ref.	Size	☒	EAN
82-325	38-39	0/200	5907558476712
82-326	40-41	0/300	5907558476729
82-327	44-43	0/220	5907558476736
82-328	44-45	0/220	5907558476743
82-329	46-47	0/200	5907558476750

Skarpety robocze

Working socks / Arbeitssocke / Рабочие носки / Шкарпетка робоча / Munkazokni / Šošetá de lucru / Pracovní ponožka / Pracovné ponožky / Delovna nogavica / Darbines kojines / Darba zeķes basic / Τόσσοκιδ / Рабочие чоран / Radne čarape / Radna čarapa / Κάλσα εργασίας / Calcetin de trabajo / Calza da lavoro / Meias de trabalho / Chaussette de travail / Werksok

GRAPHITE



Ref.	Size	info	☒	EAN
GD019	39-42	long	50/400	5902062997777
GD020	43-46	long	50/400	5902062997784
GD032	39-42	short	50/600	5902062102669
GD033	43-46	short	50/600	5902062102676



Ref.	Size	info	☒	EAN
GD017	39-42	long	50/400	5907558481785
GD018	43-46	long	50/400	5907558481792
GD030	39-42	short	50/600	5907558495294
GD031	43-46	short	50/600	5907558495300

Skarpety robocze

Working socks / Arbeitssocke / Рабочие носки / Шкарпетка робоча / Munkazokni / Şosetă de lucru / Pracovní ponožka / Pracovné ponožky / Delovna nogavica / Darbinės kojines / Darba zeķes basic / Töösokid / Работен чорап / Radne čarape / Radna čarapa / Κάλτσα εργαίας / Calzetin de trabajo / Calza da lavoro / Meias de trabalho / Chaussette de travail / Werksok

<p>COTTON 60% POLYESTER 37% ELASTANE 3%</p> <p>SOFT</p>  <p>OEKO-TEX® STANDARD 100 100000100 Zašteteno za uporabo v skladu s standardom. www.oeko-tex.com/standard100</p> <table border="1"> <thead> <tr> <th>Ref.</th> <th>Size</th> <th>⊠</th> <th>EAN</th> </tr> </thead> <tbody> <tr> <td>82-350</td> <td>39 - 42</td> <td>1/60</td> <td>5907558444605</td> </tr> <tr> <td>82-351</td> <td>43 - 46</td> <td>1/60</td> <td>5907558444612</td> </tr> </tbody> </table>	Ref.	Size	⊠	EAN	82-350	39 - 42	1/60	5907558444605	82-351	43 - 46	1/60	5907558444612	<p>COTTON 60% POLYESTER 37% ELASTANE 3%</p> <p>SOFT</p>  <p>OEKO-TEX® STANDARD 100 100000100 Zašteteno za uporabo v skladu s standardom. www.oeko-tex.com/standard100</p> <table border="1"> <thead> <tr> <th>Ref.</th> <th>Size</th> <th>⊠</th> <th>EAN</th> </tr> </thead> <tbody> <tr> <td>82-355</td> <td>39 - 42</td> <td>1/60</td> <td>5907558444629</td> </tr> <tr> <td>82-356</td> <td>43 - 46</td> <td>1/60</td> <td>5907558444636</td> </tr> </tbody> </table>	Ref.	Size	⊠	EAN	82-355	39 - 42	1/60	5907558444629	82-356	43 - 46	1/60	5907558444636	<p>COTTON 60% POLYESTER 37% ELASTANE 3%</p> <p>SOFT</p>  <p>OEKO-TEX® STANDARD 100 100000100 Zašteteno za uporabo v skladu s standardom. www.oeko-tex.com/standard100</p> <table border="1"> <thead> <tr> <th>Ref.</th> <th>Size</th> <th>⊠</th> <th>EAN</th> </tr> </thead> <tbody> <tr> <td>82-360</td> <td>39 - 42</td> <td>0/20</td> <td>5907558444643</td> </tr> <tr> <td>82-361</td> <td>43 - 46</td> <td>0/20</td> <td>5907558444650</td> </tr> </tbody> </table>	Ref.	Size	⊠	EAN	82-360	39 - 42	0/20	5907558444643	82-361	43 - 46	0/20	5907558444650	<p>COTTON 45% COOLMAX 22% POLYESTER 22% POLYAMIDE 6% ELASTANE 4%</p> <p>ODOUR STOP</p> <p>SOFT</p>  <p>OEKO-TEX® STANDARD 100 100000100 Zašteteno za uporabo v skladu s standardom. www.oeko-tex.com/standard100</p> <table border="1"> <thead> <tr> <th>Ref.</th> <th>Size</th> <th>⊠</th> <th>EAN</th> </tr> </thead> <tbody> <tr> <td>82-365</td> <td>39 - 42</td> <td>0/20</td> <td>5907558463576</td> </tr> <tr> <td>82-366</td> <td>43 - 46</td> <td>0/20</td> <td>5907558463583</td> </tr> </tbody> </table>	Ref.	Size	⊠	EAN	82-365	39 - 42	0/20	5907558463576	82-366	43 - 46	0/20	5907558463583
Ref.	Size	⊠	EAN																																																
82-350	39 - 42	1/60	5907558444605																																																
82-351	43 - 46	1/60	5907558444612																																																
Ref.	Size	⊠	EAN																																																
82-355	39 - 42	1/60	5907558444629																																																
82-356	43 - 46	1/60	5907558444636																																																
Ref.	Size	⊠	EAN																																																
82-360	39 - 42	0/20	5907558444643																																																
82-361	43 - 46	0/20	5907558444650																																																
Ref.	Size	⊠	EAN																																																
82-365	39 - 42	0/20	5907558463576																																																
82-366	43 - 46	0/20	5907558463583																																																

Rękawice robocze

Working gloves / Arbeitshandschuhe / Перчатки рабочие / Рукавици робочі / Munkakesztyű / Mānuši de lucru / Pracovní rukavice / Pracovné rukavice / Delovne rokavice / Darbo pirštīnės / Darba cimdi / Töökindad / Ръкавици работни / Radne rukavice / Radne rukavice / Γάντια εργαίας / Guantes de trabajo / Guanti da lavoro / Luvas de trabalho / Gants de travail / Werkhandschoenen

<p>LATEX COATED</p> <p>KAT II</p> <p>2143X</p> <p>CE</p>  <p>OEKO-TEX® STANDARD 100 100000100 Zašteteno za uporabo v skladu s standardom. www.oeko-tex.com/standard100</p> <table border="1"> <thead> <tr> <th>Ref.</th> <th>Size</th> <th>⊠</th> <th>EAN</th> </tr> </thead> <tbody> <tr> <td>97-640-8</td> <td>8"</td> <td>10/100</td> <td>5907558447811</td> </tr> <tr> <td>97-640-9</td> <td>9"</td> <td>10/100</td> <td>5907558447828</td> </tr> <tr> <td>97-640-10</td> <td>10"</td> <td>10/100</td> <td>5907558447835</td> </tr> </tbody> </table>	Ref.	Size	⊠	EAN	97-640-8	8"	10/100	5907558447811	97-640-9	9"	10/100	5907558447828	97-640-10	10"	10/100	5907558447835	<p>LATEX COATED</p> <p>KAT II</p> <p>3141X</p> <p>CE</p>  <p>OEKO-TEX® STANDARD 100 100000100 Zašteteno za uporabo v skladu s standardom. www.oeko-tex.com/standard100</p> <table border="1"> <thead> <tr> <th>Ref.</th> <th>Size</th> <th>⊠</th> <th>EAN</th> </tr> </thead> <tbody> <tr> <td>97-641-8</td> <td>8"</td> <td>10/100</td> <td>5907558447842</td> </tr> <tr> <td>97-641-9</td> <td>9"</td> <td>10/100</td> <td>5907558447859</td> </tr> <tr> <td>97-641-10</td> <td>10"</td> <td>10/100</td> <td>5907558447866</td> </tr> </tbody> </table>	Ref.	Size	⊠	EAN	97-641-8	8"	10/100	5907558447842	97-641-9	9"	10/100	5907558447859	97-641-10	10"	10/100	5907558447866	<p>LATEX COATED</p> <p>KAT II</p> <p>3141X</p> <p>CE</p>  <p>OEKO-TEX® STANDARD 100 100000100 Zašteteno za uporabo v skladu s standardom. www.oeko-tex.com/standard100</p> <table border="1"> <thead> <tr> <th>Ref.</th> <th>Size</th> <th>⊠</th> <th>EAN</th> </tr> </thead> <tbody> <tr> <td>97-617-8</td> <td>8"</td> <td>10/100</td> <td>5907558448023</td> </tr> <tr> <td>97-617-9</td> <td>9"</td> <td>10/100</td> <td>5907558448030</td> </tr> <tr> <td>97-617-10</td> <td>10"</td> <td>10/100</td> <td>5907558448047</td> </tr> </tbody> </table>	Ref.	Size	⊠	EAN	97-617-8	8"	10/100	5907558448023	97-617-9	9"	10/100	5907558448030	97-617-10	10"	10/100	5907558448047
Ref.	Size	⊠	EAN																																															
97-640-8	8"	10/100	5907558447811																																															
97-640-9	9"	10/100	5907558447828																																															
97-640-10	10"	10/100	5907558447835																																															
Ref.	Size	⊠	EAN																																															
97-641-8	8"	10/100	5907558447842																																															
97-641-9	9"	10/100	5907558447859																																															
97-641-10	10"	10/100	5907558447866																																															
Ref.	Size	⊠	EAN																																															
97-617-8	8"	10/100	5907558448023																																															
97-617-9	9"	10/100	5907558448030																																															
97-617-10	10"	10/100	5907558448047																																															
<p>2x LATEX COATED</p> <p>KAT II</p> <p>3141X</p> <p>CE</p>  <p>OEKO-TEX® STANDARD 100 100000100 Zašteteno za uporabo v skladu s standardom. www.oeko-tex.com/standard100</p> <table border="1"> <thead> <tr> <th>Ref.</th> <th>Size</th> <th>⊠</th> <th>EAN</th> </tr> </thead> <tbody> <tr> <td>97-643-8</td> <td>8"</td> <td>10/100</td> <td>5907558447903</td> </tr> <tr> <td>97-643-9</td> <td>9"</td> <td>10/100</td> <td>5907558447910</td> </tr> <tr> <td>97-643-10</td> <td>10"</td> <td>10/100</td> <td>5907558447927</td> </tr> </tbody> </table>	Ref.	Size	⊠	EAN	97-643-8	8"	10/100	5907558447903	97-643-9	9"	10/100	5907558447910	97-643-10	10"	10/100	5907558447927	<p>NITRILE COATED</p> <p>KAT II</p> <p>4131X</p> <p>CE</p>  <p>OEKO-TEX® STANDARD 100 100000100 Zašteteno za uporabo v skladu s standardom. www.oeko-tex.com/standard100</p> <table border="1"> <thead> <tr> <th>Ref.</th> <th>Size</th> <th>⊠</th> <th>EAN</th> </tr> </thead> <tbody> <tr> <td>97-616-8</td> <td>8"</td> <td>10/100</td> <td>5907558447996</td> </tr> <tr> <td>97-616-9</td> <td>9"</td> <td>10/100</td> <td>5907558448009</td> </tr> <tr> <td>97-616-10</td> <td>10"</td> <td>10/100</td> <td>5907558448016</td> </tr> </tbody> </table>	Ref.	Size	⊠	EAN	97-616-8	8"	10/100	5907558447996	97-616-9	9"	10/100	5907558448009	97-616-10	10"	10/100	5907558448016	<p>NITRILE COATED</p> <p>KAT II</p> <p>4131X</p> <p>CE</p>  <p>OEKO-TEX® STANDARD 100 100000100 Zašteteno za uporabo v skladu s standardom. www.oeko-tex.com/standard100</p> <table border="1"> <thead> <tr> <th>Ref.</th> <th>Size</th> <th>⊠</th> <th>EAN</th> </tr> </thead> <tbody> <tr> <td>97-642-8</td> <td>8"</td> <td>10/100</td> <td>5907558447873</td> </tr> <tr> <td>97-642-9</td> <td>9"</td> <td>10/100</td> <td>5907558447880</td> </tr> <tr> <td>97-642-10</td> <td>10"</td> <td>10/100</td> <td>5907558447897</td> </tr> </tbody> </table>	Ref.	Size	⊠	EAN	97-642-8	8"	10/100	5907558447873	97-642-9	9"	10/100	5907558447880	97-642-10	10"	10/100	5907558447897
Ref.	Size	⊠	EAN																																															
97-643-8	8"	10/100	5907558447903																																															
97-643-9	9"	10/100	5907558447910																																															
97-643-10	10"	10/100	5907558447927																																															
Ref.	Size	⊠	EAN																																															
97-616-8	8"	10/100	5907558447996																																															
97-616-9	9"	10/100	5907558448009																																															
97-616-10	10"	10/100	5907558448016																																															
Ref.	Size	⊠	EAN																																															
97-642-8	8"	10/100	5907558447873																																															
97-642-9	9"	10/100	5907558447880																																															
97-642-10	10"	10/100	5907558447897																																															

Рękawice robocze

Working gloves / Arbeitshandschuhe / Перчатки рабочие / Рукавиці робочі / Munkakesztyű / Mänuși de lucru / Pracovní rukavice / Pracovné rukavice / Delovne rokavice / Darbo pirštinės / Darba cimdi / Töökindad / Ръкавици работни / Radne rukavice / Radne rukavice / Γάντια εργασιών / Guantes de trabajo / Guanti da lavoro / Luvas de trabalho / Gants de travail / Werkhandschoenen



NITRILE COATED

KAT II



NITRILE COATED

KAT II



PU COATED

KAT II



Ref.	Size	⊠	EAN
97-610-8	8"	10/100	5907558447965
97-610-9	9"	10/100	5907558447972
97-610-10	10"	10/100	5907558447989



Ref.	Size	⊠	EAN
97-631-8	8"	10/100	5907558448146
97-631-9	9"	10/100	5907558448153
97-631-10	10"	10/100	5907558448160



Ref.	Size	⊠	EAN
97-609-8	8"	10/100	5907558447934
97-609-9	9"	10/100	5907558447941
97-609-10	10"	10/100	5907558447958



KAT I



NITRILE COATED

KAT II



ULTRA FLEX

NITRILE COATED

KAT II



Ref.	Size	⊠	EAN
97-620-8	8"	10/300	5907558448054
97-620-9	9"	10/300	5907558448061
97-620-10	10"	10/300	5907558448078



Ref.	Size	⊠	EAN
97-621-8	8"	10/100	5907558448085
97-621-9	9"	10/100	5907558448092
97-621-10	10"	10/100	5907558448108



Ref.	Size	⊠	EAN
97-622-8	8"	10/100	5907558475128
97-622-9	9"	10/100	5907558475135
97-622-10	10"	10/100	5907558475142
97-622-11	11"	10/100	5907558475159



LATEX COATED

KAT II



KAT II



KAT II



Ref.	Size	⊠	EAN
97-612-8	8"	10/100	5907558484267
97-612-9	9"	10/100	5907558484274
97-612-10	10"	10/100	5907558484281

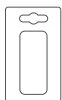

Ref.	Size	⊠	EAN
97-602	10,5"	12/96	5907558406825



Ref.	Size	⊠	EAN
97-603	10"	12/120	5907558409147
97-604	8"	0/12	5907558407655



KAT II



KAT II

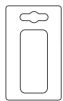

Ref.	Size	⊠	EAN
97-605	10"	0/96	5907558412901



Ref.	Size	⊠	EAN
97-606	10"	6/96	5907558412918



Rękawice robocze

Working gloves / Arbeitshandschuhe / Перчатки рабочие / Руквици работчи / Munkakesztyű / Mänuși de lucru / Pracovní rukavice / Pracovné rukavice / Delovne rokavice / Darbo pirštīnēs / Darba cimdi / Töökindad / Ръкавици работни / Radne rukavice / Radne rukavice / Γάντια εργαίας / Guantes de trabajo / Guanti da lavoro / Luvas de trabalho / Gants de travail / Werkhandschoenen



LATEX FREE
100% NITRILE
SILICONE FREE

POWDER FREE

x50 pcs
by weight



LATEX FREE
100% NITRILE
SILICONE FREE

POWDER FREE

x100 pcs
by weight



LATEX FREE
100% NITRILE
SILICONE FREE

POWDER FREE

100 PCS

SERVICE REPAIR

TOPEX

MIGAO TEXTURE



Ref.	Size	⊠	EAN
97-690-M	M	10/10	5907558484489
97-690-L	L	10/10	5907558484496
97-690-XL	XL	50/10	5907558484502



Ref.	Size	⊠	EAN
97-691-M	M	100/10	5907558484519
97-691-L	L	100/10	5907558484526
97-691-XL	XL	100/10	5907558484533



Ref.	Size	⊠	EAN
83S217-L	L	0/10	5902062122209
83S217-XL	XL	0/10	5902062122216

Opaska magnetyczna

Magnetic wristband / Магнитный браслет / Магнітний ремінець / Mágneses zsinór / Bandă magnetică / Magnetický náramek / Magnetický náramok / Magnetni trak / Magnetinis apyrankė / Magnētiskā siksnā / Magnetiline esiriba / Магнитна лента за китка / Magnetska vrpca / Магнетна трака за ношење / Μαγνητική ζώνη / Braccialetto magnetico / Pulseira magnética / Bracelet magnétique / Magnetische polsband



Ref.	⊠	EAN
GD012	10/50	5907558462425

Rękawice robocze z magnesem

Working gloves with magnet / Arbeitshandschuhe / Перчатки рабочие с магнитом / Руквици работчи / Bőr kesztyű / Mänuși de lucru / Pracovní rukavice / Pracovné rukavice / Delovne rokavice / Darbo pirštīnēs / Darba cimdi / Töökindad / Ръкавици работни / Radne rukavice / Radne rukavice / Γάντια εργαίας / Guantes de trabajo / Guanti di lavoro / Luvas de trabalho / Gants de travail / Werkhandschoenen



10"

Ref.	⊠	EAN
GD013	12/120	5907558462401
GD014	12/120	5907558462418

Okulary ochronne

Safety goggles / Schutzbrille / Очки защитные / Окуляри протиоскопні / Védőszemüveg / Ochelari protectie / Ochranné brýle / Ochranné okuliare / Zaščitna očala / Apsauginiai akiniai / Aizsargbrilles / Kaitseprillid / Очуха предпазни / Zaštitne naočale / Zastitne naočari / Γαλιλά προστασίας / Gafas protectoras / Occhiali di sicurezza / Óculos de proteção / Lunettes de protection / Beschermingsbril



Ref.	⊠	EAN
97-500	6/72	5907558406887



Ref.	⊠	EAN
97-501	6/72	5907558406894

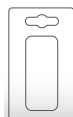

Gogle ochronne

Protective goggles / Augenschutzbrillen / Защитные очки / Окуляри захисні / Védőszemüveg / Ochelari de protectie / Ochranné brýle / Ochranné okuliare / Zaščitna očala / Apsauginiai akiniai / Aizsargbrilles / Kaitseprillid / Защитни очула / Zaštitne gogle / Zaštitne naočare / Προστατευτικά γαλιλά / Gafas protectoras / Occhiali protettivi / Óculos de proteção / Lunettes google de protection / Veiligheidsbril



F_l 45 m/s optical class I

CE



Ref.	⊠	EAN
97-510	12/300	5907558443820



ANTI FOG B_l 120 m/s

optical class I CE



Ref.	⊠	EAN
97-513	12/300	5907558443820

Oslona przeciwdpryskowa

Face protection shield / Splitterschutz / Щиток противосколочный / Щиток протиосколочний / Arcvédő / Ecran protecție față / Clona proti odpryskům / Ochranný štít / Ščitnik za obraz / Arpsauginis skydelis veidui / Pretlauskų aizsargmaska / Kaitsevisiir / Предназнен щит / Šitnik za lice / Šitnik za lice / Μάσκα κεφαλής προστασίας από θραύσματα / Máscara protectora facial / Visiera ribaltabile anti scheggia / Proteção / Protecteur anti-éclats / Bescherming tegen tegen slingerende deeltjes



Ref.	☒	EAN
97-390	1/50	5907558468953



Ref.	☒	EAN
97-391	0/20	5907558468960

Półmaska przeciwpylowa

Dust half-mask / Staubschutzmaske / Респиратор противопылевой / Респиратор захисний протипилевої / Pormasz / Mască mică protecție praf / Polomaska protiprašná / Respirátor protiprachový / Zaštitna maska / Puskaukė nuo dulkių / Aizsargmaska / Talmuvastane poolmask / Маска противопылевого / Zaštitna maska / Zaštitna maska / Ημίμασκα προστασίας από σκόνη / Máscara para polvo / Semimaschera contro polvere / Máscara contra pó / Demi-masque anti-poussière / Stof half-masker



Ref.	☒	EAN
97-300	10/120	5907558407686

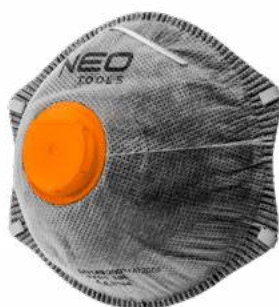

Ref.	☒	EAN
97-301	10/120	5907558407693



Ref.	☒	EAN
97-311	10/100	5907558407723

Półmaska silikonowa

Silicon mask / Silikon-Halbmaste / Силиконовая полумаска / Півмаска силіконова / Szilikon félmaszk / Semimasca cu silicon / Silikonová polomaska / Silikónový respirátor / Silikonska polmaska / Silikoninė puskaukė / Silikona pusmaska / Silikonist respirator / Силиконова полумаска / Silikonska polumaska / Silikonska polumaska / Μάσκα μισού προσώπου από σιλικόνη / Media máscarilla de silicona / Maschera di protezione / Semi-máscara em silicone / Demi-masque silicone



Ref.	☒	EAN
97-321	10/80	5907558421811

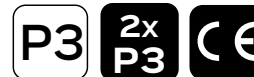

Ref.	☒	EAN
97-351	1/24	5906692022632



Ref.	☒	EAN
97-352	1/24	5906692022649



Ref.	☒	EAN
97-353	1/24	5906692022656

Pólmaska silikonowa

Silicon mask / Silikon-Halbmaste / Силиконовая полумаска / Півмаска силіконова / Szilikon félmaszk / Semimasca cu silicon / Silikonová polomaska / Silikonový respirátor / Silikonska polmaska / Silikonine puskaukë / Silikona pumaska / Silikonist respiraator / Силиконова полумаска / Silikonska polumaska / Silikonska polumaska / Μάσκα μισού προσώπου από σιλίκονη / Maschera di protezione / Semi-máscara em silicone / Demi-masque silicone



Ref.	📦	EAN
97-350	0/60	5907558407730

Filtr

Filter / Filter / Фильтр / Филтър / Szűrő / Filtru / Filtr / Filter / Filter / Filtras / Filtrs / Filter / Филтър / Filtr / Filteri za prašinu / Φίλτρο / Filtro / Filtro per mascherina / Filtro / Filtre / Filter



Ref.	📦	EAN
97-361	50/200	5907558408058



Pochłaniacz

Cartridge / Maskenfilter / Фильтрующий патрон A1 / Филтър / Szűrő / Absorbant / Pohlcovač / Pohlcovač / Absorbent / Filtras / Absorbētājs / Filter / Адсорбер / Apsorber / Prigušivač / Ανταλλακτικό φίλτρο A1 / Filtro / Cartuccia / Filtro / Absorbeur



Ref.	📦	EAN
97-360	50/200	5907558407747



Ref.	📦	EAN
97-362	50/200	5907558409130



Ref.	📦	EAN
97-363	0/100	5906692022663



Czapka z daszkiem

Work cap / Schildmütze / Бейсболка рабочая / Бейсболка робоча / Láthatósági sapka / Sapca cuazoroz / Pracovní kšiltovka / Čapka so šiltom, pracovná / Delovna kapa s šiltom / Kepure su snapelju / Darba cepure ar nagu / Nokaga töömüts / Рабочна шапка с козурка / Radna kapa / Radnička kapa / Καπέλο εργασίας τύπου μπέιζμπολ / Gorra de trabajo / Cappello / Boné de trabalho / Casquette de travail à visière



Ref.	📦	EAN
97-590	0/50	5907558415728

Pasek

Belt / Gürtel / Ремень / Ремінь / Öv / Curea / opasek / Opasok / Pašček / Dirželis / rankiams / Josta / Rihm / Kolan / Pojas / Kaiš / Ζώνη / Cinturón / Cintura / Riem



Ref.	L [cm]	📦	EAN
81-900	130	0/160	5907558431148

Nakolanniki ochrone

Knee protector / Knieschützer / Наколенники защитные / Щитки наколінні захисні / Térdvédő zselés / Genunchiërä protectoare / Nákolenky / Chránič kolien / Ščitniki za kolena / Apsauga keliams / Celgalu aizsargi / Pólvekaitse / Наколенки / Štitnik za koljena / Štitnik za kolena / Επιγονατίδες προστατευτικές / Rodilleras de protecció / Ginocchiere / Protecção de joelhos / Protège-genoux / Kniebescherming



Ref.	📦	EAN
97-536	6/24	5907558407679



Ref.	📦	EAN
97-535	6/24	5907558419627

Wkładki piankowe na kolana

Knee foam pads / Knieeinlagen aus Schaumstoff / Вставки-наколенники из пеноматериала / Наколінники поліуретанові / Térdelöl betét / Insertii de spuma pentru genunchi / Pěnové vložky kolen / Penové vložky na kolená / Penasti štitniki za kolena / Arsauga keliams su putų pagalvėlemis / Putuplasta ieliktni celgaliem / Vahtplastist põlvkaitimed / Наколенники от пены / Pjenasti štitnik za koljeno / Jastučici od pene za kolena / Προσθαφαιρούμενες επιπρωταίτες από αφρώδες υλικό / Rodilleras de espuma / Ginocchiere / Almofada de espuma para joelho / Inserts de protection en mousse pour genoux / Schuimkniebescherming

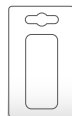
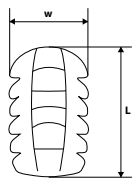

Ref.	W [mm]	L [mm]	Info	EAN
97-530	175	265	0/25	5907558419610

Wkładki przeciwhałasowe

Earplugs / Ohrstöpsel / Противошумные вкладыши / Бөрүха ("берүши") / Földugó pár / Antifoane / zátky do uší / Zátkové chrániče sluchu / Šepki za ušesa / Ausų kaištukai / Ausu aizbāžņi / Kōrvatropid / Антифону, поставяни на ушите / Šepici za uši / Šepovi za uši / Οτοασπίδες / Tapones para los oídos / Tappi per le orecchie / Tappões de ouvidos / Bouchons d'oreille / Oordopjes

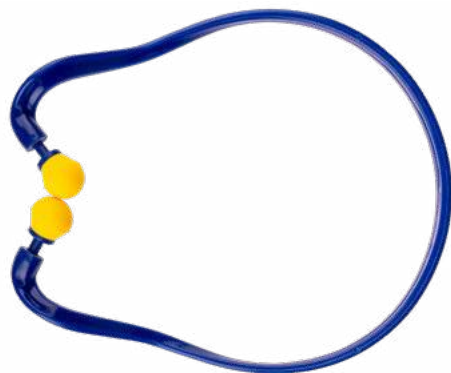

29 dB EN352

Ref.	Info	Info	EAN
97-553	29dB	15/300	5907558481655

32 dB EN352



Ref.	Info	Info	EAN
97-554	29dB	30/600	5907558481662

Wkładki przeciwhałasowe

Earplugs / Ohrstöpsel / Противошумные вкладыши / Бөрүха ("берүши") / Földugó pár / Antifoane / zátky do uší / Zátkové chrániče sluchu / Šepki za ušesa / Ausų kaištukai / Ausu aizbāžņi / Kōrvatropid / Антифону, поставяни на ушите / Šepici za uši / Šepovi za uši / Οτοασπίδες / Tapones para los oídos / Tappi per le orecchie / Tappões de ouvidos / Bouchons d'oreille / Oordopjes

33 dB SIZE 9/11 x10 CE EN352



Ref.	Size	Info	Info	EAN
97-550	9/11	33dB	25/500	5907558419634

x10 CE EN352

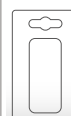

Ref.	Size	Info	Info	EAN
97-555	5/16	29dB	40/800	5907558419641

x1000 (500 pairs) 38 dB EN352



Ref.	Info	Info	EAN
97-552	38dB	0/20	5907558481648



Wentylator

Fan / Fan / вентилятор / вентилятор / ventilátor / ventilator / větrák / vetrák / Ventilator / Ventilatorius / Ventilators / Ventilator / Вентилятор / Ventilator / Πενασα / Ανεμιστήρας / Admirador / Fan / Fan / Ventilateur

50W Ø 40 CM 3 AIRFLOW SPEEDS L R COPPER MOTOR



Ref.	☒	EAN
90-001	0/1	5907558442717

45W Ø 40 CM 3 AIRFLOW SPEEDS L R TIMER 0,5 - 7,5 h REMOTE CONTROL NORMAL SLEEP/ NATURA COPPER MOTOR



Ref.	☒	EAN
90-002	0/1	5907558442724

100W Ø 45 CM 3 AIRFLOW SPEEDS L R HEAVY DUTY EXTRA POWER COPPER MOTOR



Ref.	☒	EAN
90-003	0/1	5907558442731

50W Ø 40 CM 3 AIRFLOW SPEEDS L R



Ref.	☒	EAN
90-015	0/1	5906692020010



50W Ø 30 CM 3 AIRFLOW SPEEDS METAL BODY COPPER MOTOR



Ref.	☒	EAN
90-009	0/1	5907558466225

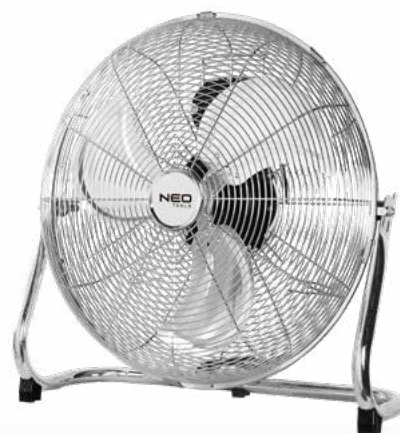

100W Ø 45 CM 3 AIRFLOW SPEEDS METAL BODY COPPER MOTOR



Ref.	☒	EAN
90-010	0/1	5907558466232

Wentylator

Fan / Fan / вентилятор / вентилятор / ventilator / ventilator / větrák / vetrák / Ventilator / Ventilatorius / Ventilators / Ventilator / Вентилятор / Ventilator / Ленеца / Ανεμιστήρας / Admirador / Fan / Fan / Ventilateur



50W

70°
oscillation

modes:
• normal
• nature
• sleep

REMOTE CONTROL

L R

Ref.	📦	EAN
90-012	0/1	5906692015016



60 W

3
AIRFLOW SPEEDS

IONIZATION

TIMER

WIFI

Ref.	📦	EAN
90-017	0/1	5906692029488



70°
oscillation

Ø
40 CM

3
AIRFLOW SPEEDS

L R

30x
31.5x
58.5cm

Ref.	📦	EAN
90-011	0/1	5906692015009



Ø
20 CM

3
AIRFLOW SPEEDS

L R

Ref.	📦	EAN
90-016	1/4	5906692029471

Promiennik

Infrared heater / Heizkörper / Радиатор / Radiator / Radiator / Radiator / Radiator / Infrardečī grelec / Infraraudonųjų spindulių šildytuvas / Infrasarkanais sildītājs / Infraruna kütteseade / Инфрачервен нагревател / Infraczerwony grzejnik / Инфрачервоні грійач / Υπέριυθη θερμάστρα / Calentador de infrarrojos / Riscaldatore a infrarossi / Infrarood verwarming / Chauffage infrarouge



2kW

18m²

6000h

golden halogen lamp

IP65

Ref.	📦	EAN
90-030	0/6	5907558447415



2kW

carbon infrared heating lamp

10 000h

IP55

32m²

Ref.	📦	EAN
90-039	0/4	5907558457902

Promiennik

Infrared heater / Heizkörper / Ραδιатор / Radiator / Radiator / Radiator / Radiator / Infrarødeci grelec / Infraradonujų spindulių šildytuvas / Infrasarkanais sildītājs / Infrapuna kütteseade / Инфрарчервен нагрєватєл / Infracrveni grijač / Инфрацрєвєнє грєјач / Υπέρυθρη θερμάστρα / Calentador de infrarrojos / Riscaldatore a infrarossi / Infrarood verwarming / Chauffage infrarouge



1.5 kW

- halogen lamp
- 9m²
- 5000h
- IP44

Ref.	⊠	EAN
90-034	0/2	5907558447453



400/800 W

- QUARZ

Ref.	⊠	EAN
90-112	0/8	5907558495348



1,5 kW

- halogen lamp
- 5000h
- aluminium body
- IP44

Ref.	⊠	EAN
90-037	0/1	5907558457889



400/800/1200W

- ROTARY BASE
- CARRYING HANDLE
- HALOGEN LAMP

Ref.	⊠	EAN
90-113	0/1	5907558495355



2kW

- 24m²
- 6000h
- low glare amber lamp
- IP65

Ref.	⊠	EAN
90-032	0/4	5907558447439



400/800/1200W

- HALOGEN LAMP
- ROTARY BASE

Ref.	⊠	EAN
90-114	0/1	5907558495362



1kW

- carbon fiber lamp
- 3m²
- AUTO OFF
- 6000h
- IP44

Ref.	⊠	EAN
90-035	0/4	5907558447460



600/1200 W

- QUARZ
- WHEELS

Ref.	⊠	EAN
90-111	0/1	5907558495331

Nagrzewnica olejowa

Oil heater / Ölheizung / Масляный нагреватель / Масляний нагрівач / Olajmelegítő / Incălzitor cu ulei / Ohřivač oleje / Ohrievač oleja / Grelnik olja / Alyvos šildytuvas / Eļļas sildītājs / Ölkütteseade / Нагревател на масло / Grijač ulja / Грејач уља / Θερμαντήρας λαβίου / Calentador de aceite / Riscaldatore dell'olio / Olie verwarmmer / Réchauffeur d'huile

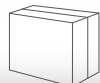

Ref.	P [kW]	[m³/h]	☒	EAN
90-080	20	550	0/1	5907558457919



Ref.	P [kW]	[m³/h]	[l]	☒	EAN
90-081	30	750	34	0/1	5907558457926
90-082	50	1100	50	0/1	5907558457933



Ref.	P [kW]	[m³/h]	☒	EAN
90-086	20	600	0/1	5907558495423

Nagrzewnica gazowa

Gas heater / Gasheizung / Газовый обогреватель / Газовий обігрівач / Gázmelegítő / Incălzitor pe gaz / Plynový ohřivač / Plynový ohrievač / Plinski grelec / Dujinis šildytuvas / Gāzes sildītājs / Gaasikütteseade / Газов нагривател / Plinski grijač / Гасни зрегач / Θερμαντήρας αερίου / Calentador a gas / Stufa a gas / Gaskachel / Chauffage à gaz



Ref.	P [kW]	[m³/h]	[bar]	☒	EAN
90-083	15	580	0,7	0/1	5907558457940
90-084	30	1000	0,7	0/1	5907558457957
90-085	50	1000	1,5	0/1	5907558457964



Piecyk gazowy na butle z reduktorem i wężem

Gas heater for cylinders with a reducer and a hose / Gasheizofen mit Regler und Schlauch / Газовый обогреватель с редуктором и шлангом / Gázpalackos tűzhely szabályozóval és tömlővel / Soba pe gaz butelie cu regulator si furtun / Ohřivač plynových lahví s redukcí a hadicí / Plynový ohřivač s redukcí a hadicou / Plinska peč z cev in regulator / Dujų baliono šildytuvas su reduktoriumi ir žarna / Gāzes balona sildītājs ar reduktoru un šļūteni / Gaasiballooni soojendus koos reduktori ja voolikuga / Готварска печка с газова бутилка, регулатор и маркуч / Grijač plinske boce s reduktorom i srijevom / Грејач гасног цилиндра са редуктором и цревом / Φιάλη αερίου κουζίνας με ρυθμιστή και σωλήνα / Stufa a gas per bombola con riduttore e tuba flessibile / Aquecedor de botija de gás com regulador e mangueira / Alentador de gas de con regulador y manguera / Chauffage au gaz de bouteille de gaz avec réducteur et tuyau / Gaskachel voor cilinders met regelaar en slang



Ref.	📦	EAN
90-118	1/1	5907558476644

Promiennik gazowy na butle

Radiant gas heater for cylinder / Gasflaschen-Heizstrahler / Газовый обогреватель для баллонов / Балонний газовий обігрівач / Gázpalackos sugárzó fűtőtest / Incălzitor radiant cu butelie de gaz / Plynový sálavý ohřivač / Plynový ohřivač pre plynové fľaše / Plinski grelnik z jeklenko / Dujų baliono spindulinis šildytuvas / Gāzes balona starojuma sildītājs / Gaasisoojendi balloonidele / Лъчист нагревател с газова бутилка / Plinski grijač za boce / Гасни грејач за цилиндри / Θερμάστρα Υγραερίου για φιάλη / Riscaldatore radiante con bombola / Aquecedor radiante de botija de gás 4600W / Calefactor radiante de cilindro de gas / Chauffage radiant à gaz / Gasflesstraler

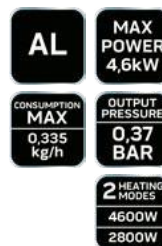

Ref.	📦	EAN
90-119	1/6	5907558476651

Grzejnik turystyczny gazowy

Gas tourist heater / Газовый туристичний обігрівач / Încălzitor turistic pe gaz / Gázuturisztikai fűtőberendezés / Riscaldatore turistico a gas / Chauffage touristique au gaz / Gastouristen-Heizung / Газовый туристический обогреватель / Plynové turistické topení / Plynový turistický ohřivač / Plinska turistička grijalica / Dujinis turistinis šildytuvas / Gāzes tūristu sildītājs / Plinski turistični grelnik / Газов туристическо отопление / Gasni turistički grejač / Τουριστικός θερμαντήρας αερίου / Toeristenverwarming op gas / Calentador turístico de gas / Aquecedor turístico a gás



Ref.	📦	EAN
90-133	1/2	5906692022076

Promiennik gazowy na kartusz

Gas cartridge heater / Газовый картриджный обігрівач / Încălzitor cu cartuş de gaz / Gázpatronos fűtőtest / Riscaldatore a gas a cartuccia / Chauffage à cartouche au gaz / Gas-Heizpatrone / Газовый картриджный нагреватель / Plynové topné těleso / Plynový ohřivač s kazetou / Plinski grijač s uloškom / Dujinis kasetinis šildytuvas / Gāzes kārtiņģa sildītājs / Plinski grelnik / Газов нагревател с касета / Гасни грејач са картриџом / Θερμαντήρας φυσιγγών αερίου / Gas cartridge verwarming / Aquecedor de cartucho a gás / Calentador de cartucho de gas / Kasetiga gaasikütteeseade



Ref.	📦	EAN
90-134	1/12	5906692022083



Ref	p.	Ref	p.	Ref	p.	Ref	p.	Ref	p.	Ref	p.	Ref	p.
01-010	75	01-270	75	01-635	139	04-001	63	04-196	67	08-021	47	08-194	46
01-011	75	01-271	75	01-636	139	04-002	63	04-197	67	08-022	47	08-195	46
01-012	75	01-272	75	01-637	139	04-004	63	04-199	70	08-023	47	08-196	46
01-013	75	01-273	75	01-638	139	04-006	64	04-200	70	08-024	47	08-197	46
01-014	75	01-274	75	01-639	139	04-007	64	04-201	66	08-025	47	08-220	45
01-015	76	01-275	76	01-640	139	04-011	63	04-204	65	08-026	47	08-221	45
01-016	76	01-276	76	01-641	139	04-012	63	04-206	65	08-027	47	08-222	45
01-017	76	01-277	76	01-642	139	04-013	63	04-207	65	08-028	47	08-223	45
01-018	76	01-278	76	01-643	139	04-014	63	04-208	65	08-029	47	08-224	45
01-019	77	01-279	77	01-644	139	04-015	63	04-209	67	08-030	47	08-225	45
01-020	77	01-280	77	01-645	139	04-016	63	04-210	67	08-032	47	08-226	45
01-021	78	01-290	77	01-646	139	04-019	64	04-211	67	08-036	47	08-227	45
01-022	78	01-291	77	01-647	139	04-020	64	04-213	65	08-039	47	08-228	45
01-026	174	01-292	77	01-648	139	04-021	64	04-214	66	08-040	47	08-229	45
01-027	174	01-293	77	01-649	139	04-022	64	04-220	71	08-041	47	08-230	45
01-028	174	01-306	73	01-650	139	04-023	64	04-221	72	08-042	47	08-231	45
01-085	79	01-307	73	01-651	139	04-024	64	04-222	72	08-043	47	08-232	45
01-086	79	01-308	72	01-652	139	04-025	64	04-228	69	08-044	47	08-235	45
01-087	79	01-309	72	01-653	139	04-026	64	04-231	70	08-045	47	08-236	45
01-088	79	01-311	73	01-654	139	04-028	64	04-240	65	08-046	47	08-237	45
01-089	79	01-312	74	01-655	139	04-031	64	04-241	67	08-047	47	08-238	45
01-090	79	01-400	84	01-656	139	04-032	64	04-242	66	08-048	47	08-239	45
01-091	79	01-401	87	01-657	139	04-033	64	04-250	70	08-049	47	08-240	45
01-092	79	01-402	57	01-658	139	04-034	64	04-602	195	08-050	47	08-241	45
01-093	79	01-500	84	01-659	139	04-035	64	04-603	191	08-051	47	08-242	45
01-094	79	01-501	85	01-660	139	04-036	64	04-608	192	08-052	47	08-243	45
01-095	79	01-502	85	01-661	139	04-037	70	04-612	191	08-053	47	08-244	45
01-096	79	01-503	86	01-662	139	04-044	64	04-613	192	08-054	47	08-245	45
01-097	79	01-506	85	01-663	139	04-045	64	04-616	190	08-055	47	08-246	45
01-101	77	01-507	85	01-664	139	04-046	64	04-617	129	08-056	47	08-247	45
01-102	78	01-509	78	01-665	139	04-051	71	04-618	192	08-058	47	08-251	50
01-103	78	01-510	87	01-666	139	04-052	71	04-619	190	08-061	36	08-252	50
01-105	77	01-511	87	01-667	139	04-053	71	04-620	199	08-070	47	08-253	50
01-106	78	01-512	88	01-668	139	04-054	71	04-630	27	08-071	47	08-254	50
01-150	78	01-513	87	01-669	139	04-055	71	04-631	27	08-072	47	08-255	50
01-151	78	01-514	87	01-670	139	04-062	71	04-700	195	08-073	47	08-256	50
01-152	75	01-515	87	01-671	139	04-063	71	04-701	195	08-074	47	08-257	57
01-153	75	01-518	87	01-672	140	04-071	71	04-710	196	08-075	47	08-300	47
01-154	75	01-519	84	02-001	57	04-072	71	04-715	194	08-076	47	08-301	47
01-155	75	01-520	84	02-002	57	04-073	71	04-716	194	08-077	47	08-302	47
01-156	76	01-524	84	02-040	89	04-112	68	04-719	193	08-078	47	08-304	47
01-157	76	01-525	81	02-042	89	04-113	68	04-720	193	08-080	47	08-306	47
01-158	76	01-526	140	02-044	89	04-114	68	04-721	195	08-081	47	08-307	47
01-200	88	01-530	86	02-111	89	04-115	68	04-738	27	08-082	47	08-308	47
01-202	88	01-531	86	02-401	88	04-116	68	04-739	27	08-083	47	08-309	47
01-203	88	01-532	86	02-402	89	04-117	68	06-011	214	08-084	47	08-311	47
01-204	88	01-533	86	02-403	89	04-130	71	06-020	214	08-085	47	08-312	47
01-216	79	01-534	84	02-406	89	04-131	71	06-036	214	08-086	47	08-313	47
01-217	79	01-535	72	02-412	88	04-132	71	06-037	214	08-090	125	08-314	47
01-220	80	01-536	85	02-413	88	04-133	71	06-040	214	08-091	125	08-315	47
01-221	80	01-537	86	02-415	89	04-136	71	06-070	214	08-095	125	08-316	47
01-222	80	01-539	85	02-416	89	04-137	71	06-071	214	08-151	50	08-319	47
01-223	80	01-540	85	02-417	89	04-138	71	06-072	214	08-152	50	08-320	48
01-224	80	01-542	85	02-418	89	04-139	71	06-073	214	08-153	50	08-321	48
01-225	80	01-543	87	02-419	89	04-142	72	06-101	213	08-154	50	08-322	48
01-226	81	01-546	84	02-429	89	04-143	71	06-103	213	08-155	50	08-323	48
01-227	81	01-547	84	02-435	88	04-171	63	06-104	213	08-168	46	08-324	48
01-228	81	01-548	86	02-444	88	04-172	63	06-105	213	08-170	46	08-325	48
01-229	82	01-549	84	03-010	90	04-173	63	06-106	213	08-171	46	08-326	48
01-231	81	01-552	83	03-011	90	04-174	63	06-107	54	08-172	46	08-327	48
01-232	81	01-553	83	03-012	90	04-175	63	06-111-1	69	08-173	46	08-328	48
01-233	81	01-555	86	03-013	90	04-176	63	06-115	68	08-174	46	08-329	48
01-234	82	01-562	83	03-014	90	04-177	64	06-116	68	08-175	46	08-331	48
01-235	83	01-566	87	03-015	90	04-178	64	06-127	69	08-176	46	08-332	48
01-236	83	01-615	140	03-016	90	04-179	64	06-129	69	08-177	46	08-333	48
01-237	82	01-620	139	03-017	90	04-180	64	06-130	69	08-178	46	08-335	48
01-240	80	01-621	139	03-019	90	04-181	64	08-002	20	08-179	46	08-340	47
01-241	80	01-622	139	03-020	90	04-182	64	08-008	47	08-180	46	08-341	47
01-242	80	01-623	139	03-021	90	04-183	64	08-009	47	08-181	46	08-350	50
01-243	81	01-624	139	03-022	90	04-184	64	08-010	47	08-182	46	08-351	50
01-244	81	01-625	139	03-023	90	04-185	64	08-011	47	08-184	46	08-352	50
01-245	82	01-626	139	03-024	90	04-186	64	08-012	47	08-185	46	08-353	50
01-250	75	01-627	139	03-025	90	04-187	64	08-013	47	08-186	46	08-355	49
01-251	75	01-628	139	03-026	90	04-188	64	08-014	47	08-187	46	08-356	50
01-252	75	01-629	139	03-027	90	04-189	64	08-015	47	08-188	46	08-357	50
01-253	75	01-630	139	03-028	90	04-190	64	08-016	47	08-189	46	08-408	46
01-254	76	01-631	139	03-029	90	04-191	66	08-017	47	08-190	46	08-409	46
01-255	76	01-632	139	03-030	62	04-192	66	08-018	47	08-191	46	08-410	46
01-256	76	01-633	139	03-031	62	04-193	66	08-019	47	08-192	46	08-411	46
01-257	76	01-634	139	03-034	63	04-194	66	08-020	47	08-193	46	08-412	46

Ref	p.	Ref	p.	Ref	p.	Ref	p.	Ref	p.	Ref	p.	Ref	p.
08-413	46	08-520	49	08-754	52	09-053	60	09-412	59	09-674	59	09-980	63
08-414	46	08-521	49	08-755	52	09-054	60	09-413	59	09-675	59	10-000	35
08-415	46	08-523	49	08-756	52	09-055	60	09-414	59	09-706	59	10-004	35
08-416	46	08-524	49	08-757	52	09-056	60	09-415	59	09-707	59	10-008	36
08-417	46	08-525	49	08-758	52	09-057	60	09-416	59	09-708	59	10-019	44
08-418	46	08-530	48	08-759	52	09-058	60	09-417	59	09-709	59	10-020	35
08-419	46	08-533	48	08-760	52	09-059	60	09-418	59	09-710	59	10-030	35
08-421	46	08-536	48	08-761	52	09-060	60	09-419	59	09-711	59	10-042	37
08-422	46	08-540	49	08-762	52	09-061	60	09-421	59	09-712	59	10-054	37
08-423	46	08-543	49	08-763	52	09-062	60	09-422	59	09-713	59	10-059	38
08-424	46	08-546	49	08-764	52	09-063	60	09-424	59	09-714	59	10-060	38
08-425	46	08-550	50	08-765	52	09-064	60	09-427	59	09-715	59	10-062	39
08-426	46	08-551	50	08-766	52	09-065	60	09-429	59	09-716	59	10-066	40
08-427	46	08-552	50	08-767	52	09-066	60	09-430	59	09-717	59	10-076	42
08-429	46	08-553	50	08-770	51	09-067	60	09-432	59	09-718	59	10-078	43
08-430	46	08-554	50	08-771	51	09-068	60	09-509	57	09-719	59	10-206	39
08-431	46	08-555	50	08-772	51	09-069	60	09-512	56	09-720	59	10-216	41
08-432	46	08-556	50	08-773	51	09-141	63	09-517	56	09-721	59	10-240	35
08-442	45	08-557	50	08-774	51	09-143	63	09-518	56	09-722	59	10-250	157
08-443	45	08-558	50	08-775	51	09-145	63	09-523	55	09-723	59	10-251	157
08-444	45	08-559	50	08-776	51	09-147	63	09-524	56	09-724	59	10-252	157
08-446	45	08-560	50	08-777	51	09-149	63	09-525	55	09-725	59	10-253	158
08-447	45	08-562	50	08-778	51	09-151	63	09-526	56	09-727	59	10-254	158
08-448	45	08-563	50	08-780	51	09-176	62	09-530	55	09-728	59	10-255	158
08-449	45	08-564	50	08-781	51	09-203	63	09-531	55	09-729	59	10-256	158
08-450	45	08-565	50	08-782	51	09-205	63	09-532	55	09-730	59	10-257	158
08-451	45	08-580	48	08-783	51	09-208	63	09-533	55	09-732	59	10-258	157
08-452	45	08-581	48	08-784	51	09-212	63	09-534	55	09-734	59	10-259	157
08-453	45	08-582	48	08-821	58	09-214	63	09-535	55	09-736	59	10-260	157
08-454	45	08-583	48	08-822	58	09-255	61	09-536	55	09-738	59	10-261	157
08-458	46	08-584	48	08-823	58	09-256	61	09-537	55	09-741	59	10-262	157
08-459	46	08-585	48	08-824	58	09-257	61	09-538	55	09-746	59	10-263	157
08-460	46	08-586	48	08-825	58	09-258	61	09-539	55	09-747	59	10-264	157
08-461	46	08-587	48	08-826	58	09-259	61	09-540	55	09-749	59	10-265	157
08-462	46	08-588	48	08-827	58	09-260	61	09-541	55	09-751	60	10-300	48
08-463	46	08-589	48	08-828	58	09-261	61	09-542	55	09-752	60	10-310	51
08-464	46	08-590	48	08-830	59	09-262	61	09-543	55	09-753	60	10-311	51
08-465	46	08-591	48	08-835	58	09-263	61	09-544	55	09-754	60	10-312	51
08-466	46	08-592	48	08-837	58	09-264	61	09-545	55	09-760	60	10-313	51
08-467	46	08-593	48	08-838	58	09-265	61	09-546	55	09-761	60	10-314	51
08-468	46	08-594	48	08-839	58	09-266	61	09-550	56	09-762	60	10-315	51
08-469	46	08-595	48	08-843	58	09-270	62	09-551	56	09-763	60	10-316	51
08-470	46	08-596	48	08-845	58	09-302	63	09-552	56	09-764	60	10-317	51
08-471	46	08-597	48	08-947	50	09-320	60	09-553	56	09-765	60	10-318	51
08-472	46	08-598	48	08-960	212	09-321	60	09-554	56	09-766	60	10-319	51
08-473	46	08-599	48	08-961	212	09-322	60	09-555	56	09-767	60	10-320	51
08-474	46	08-603	45	08-962	212	09-323	60	09-556	56	09-768	60	10-321	51
08-475	46	08-649	54	08-963	212	09-324	60	09-557	56	09-769	60	10-322	52
08-476	46	08-650	48	08-964	212	09-325	60	09-558	56	09-770	60	10-323	52
08-477	46	08-651	48	08-965	212	09-326	60	09-559	56	09-771	60	10-324	52
08-478	46	08-694	35	08-966	212	09-327	60	09-571	56	09-791	60	10-325	52
08-479	46	08-705	52	08-967	212	09-328	60	09-573	57	09-806	61	10-326	52
08-480	46	08-706	52	08-968	212	09-329	60	09-575	216	09-808	61	10-327	52
08-482	46	08-707	53	08-969	212	09-330	60	09-576	216	09-810	61	10-328	52
08-486	46	08-708	53	08-970	212	09-331	60	09-577	216	09-812	61	10-329	51
08-487	45	08-710	54	08-971	212	09-333	60	09-579	216	09-814	61	10-330	51
08-488	45	08-711	53	08-972	212	09-334	60	09-580	216	09-816	61	10-331	51
08-489	45	08-712	158	08-973	212	09-336	60	09-584	216	09-817	61	10-332	51
08-490	45	08-713	53	08-974	212	09-338	60	09-585	216	09-818	61	10-333	51
08-491	45	08-720	203	08-975	212	09-339	60	09-587	216	09-819	61	10-334	51
08-492	45	08-721	203	08-976	212	09-340	60	09-588	216	09-820	61	10-335	51
08-493	45	08-722	203	08-977	212	09-341	60	09-650	59	09-821	61	10-336	51
08-494	45	08-730	51	08-978	212	09-342	60	09-651	59	09-824	61	10-337	51
08-495	45	08-731	51	08-979	212	09-345	61	09-652	59	09-825	61	10-338	51
08-497	45	08-732	51	08-980	212	09-360	62	09-653	59	09-851	61	10-339	51
08-498	45	08-733	51	08-981	212	09-361	62	09-654	59	09-852	61	10-340	52
08-499	45	08-734	51	08-982	212	09-362	62	09-655	59	09-860	61	10-341	52
08-501	49	08-735	51	08-990	206	09-363	62	09-656	59	09-890	20	10-342	52
08-502	49	08-736	51	08-991	206	09-364	62	09-657	59	09-906	62	10-343	52
08-503	49	08-740	51	08-992	206	09-365	62	09-658	59	09-908	62	10-344	52
08-504	49	08-741	51	08-993	206	09-366	62	09-659	59	09-910	62	10-345	52
08-507	49	08-742	51	08-994	206	09-367	62	09-660	59	09-912	62	10-346	52
08-508	49	08-743	51	08-995	206	09-368	62	09-661	59	09-914	62	10-401	142
08-511	49	08-744	51	08-996	206	09-370	62	09-662	59	09-916	62	10-402	142
08-512	49	08-745	51	09-042	60	09-406	59	09-663	59	09-918	62	10-403	142
08-513	49	08-746	51	09-043	60	09-407	59	09-665	59	09-920	62	10-404	142
08-514	49	08-750	52	09-044	60	09-408	59	09-666	59	09-921	62	10-405	142
08-515	49	08-751	52	09-045	60	09-409	59	09-668	59	09-924	62	10-406	142
08-516	49	08-752	52	09-051	60	09-410	59	09-671	59	09-930	62	10-407	142
08-519	49	08-753	52	09-052	60	09-411	59	09-672	59	09-952	62	10-408	142

Ref	p.	Ref	p.	Ref	p.	Ref	p.	Ref	p.	Ref	p.	Ref	p.
10-450	24	10-803	97	11-224	122	11-372	94	11-762	22	11-963	136	12-628	160
10-451	24	10-804	97	11-226	122	11-373	94	11-763	22	11-969	138	12-630	160
10-452	24	10-805	97	11-227	122	11-380	95	11-796	103	11-970	135	12-631	160
10-453	24	10-806	97	11-228	122	11-381	95	11-797	104	11-971	137	12-632	160
10-454	24	10-807	97	11-231	95	11-382	95	11-798	103	11-972	137	12-635	160
10-455	24	10-808	98	11-235	95	11-383	96	11-799	105	11-973	137	12-636	160
10-456	24	10-809	98	11-237	94	11-384	96	11-801	104	11-974	137	12-637	160
10-470	168	10-810	96	11-238	95	11-400	135	11-802	104	11-975	136	12-640	160
10-471	168	10-811	96	11-239	94	11-401	135	11-803	104	11-976	138	12-641	160
10-472	144	10-812	98	11-240	95	11-402	135	11-804	104	11-977	138	12-645	160
10-473	144	10-813	98	11-241	95	11-403	135	11-805	104	11-978	138	12-646	160
10-474	167	10-815	100	11-242	94	11-404	135	11-806	104	11-979	137	12-650	160
10-475	167	10-850	170	11-243	94	11-450	171	11-807	104	11-980	137	12-651	160
10-477	168	10-860	168	11-250	123	11-451	171	11-808	104	11-981	135	12-655	160
10-478	22	10-900	55	11-261	124	11-452	171	11-810	105	11-983	138	12-656	160
10-480	144	10-902	55	11-262	124	11-453	171	11-811	105	11-984	110	12-904	109
10-481	144	10-904	55	11-263	124	11-454	171	11-812	107	11-985	110	12-905	109
10-482	144	10-906	55	11-264	124	11-455	171	11-813	107	11-986	110	12-906	109
10-485	170	10-908	55	11-265	125	11-456	171	11-816	105	11-991	139	12-907	109
10-500	145	10-910	55	11-266	125	11-457	170	11-817	126	11-992	139	12-908	109
10-501	145	10-920	55	11-267	123	11-458	171	11-819	127	11-993	138	12-909	108
10-502	145	10-922	55	11-268	99	11-459	170	11-822	135	11-997	168	12-910	109
10-503	145	10-924	55	11-269	100	11-460	171	11-823	135	12-070-1	159	12-915	108
10-504	145	10-926	55	11-270	128	11-461	171	11-824	135	12-071-1	159	12K010-1	161
10-505	146	10-928	55	11-271	126	11-462	170	11-825	135	12-072-1	159	12K020-1	161
10-506	146	10-940	55	11-273	100	11-463	170	11-827	126	12-074-1	159	12K021-1	162
10-507	146	10-942	55	11-299	117	11-470	168	11-832	111	12-075-1	159	12K022-1	162
10-508	147	10-944	55	11-300	112	11-471	168	11-834	110	12-076-1	159	12K023	161
10-509	146	10-946	55	11-301	112	11-472	167	11-836	110	12-079	159	12K024	161
10-510	146	10-948	55	11-302	112	11-473	167	11-847	105	12-080	159	12K030-1	161
10-511	146	10-960	55	11-303	112	11-474	167	11-848	107	12-081	159	12K031-1	161
10-569	147	10-970	55	11-304	112	11-475	168	11-850	106	12-101	157	14-001	151
10-570	147	10-972	55	11-305	113	11-476	172	11-851	106	12-102	157	14-002	151
10-571	147	10-978	55	11-306	112	11-477	22	11-852	106	12-105	157	14-003	151
10-572	147	10-980	55	11-307	113	11-500	99	11-857	106	12-107	157	14-005	151
10-573	147	10-982	55	11-310	113	11-501	99	11-858	106	12-110	157	14-006	151
10-574	147	10-988	55	11-311	114	11-502	99	11-859	106	12-115	157	14-008	151
10-575	147	11-020	80	11-312	113	11-503	100	11-861	106	12-210	156	14-009	151
10-576	147	11-021	80	11-313	113	11-510	96	11-862	106	12-212	156	14-011	152
10-577	147	11-022	80	11-314	114	11-511	96	11-865	106	12-213	156	14-012	152
10-578	147	11-024	80	11-315	114	11-532	99	11-866	106	12-214	156	14-014	152
10-579	147	11-030	135	11-316	114	11-550	97	11-867	106	12-215	156	14-015	152
10-580	147	11-100	103	11-317	114	11-551	98	11-868	106	12-216	156	14-017-400	155
10-581	147	11-101	103	11-320	114	11-552	98	11-869	106	12-217	156	14-018	153
10-582	147	11-102	103	11-321	115	11-553	98	11-870	106	12-219	156	14-019	152
10-583	147	11-111	103	11-322	115	11-555-1	98	11-871	106	12-221	156	14-021	153
10-584	147	11-112	103	11-323	115	11-556	98	11-872	106	12-222	156	14-022	152
10-585	147	11-113	104	11-324	115	11-557	98	11-873	106	12-224	156	14-023	153
10-586	147	11-122	101	11-325	115	11-560	97	11-875	100	12-310	156	14-025	154
10-587	147	11-123	101	11-326	115	11-561	97	11-880	119	12-312	156	14-027	154
10-588	148	11-125	101	11-330	116	11-565	99	11-881	119	12-313	156	14-029	155
10-590	148	11-126	101	11-331	116	11-600	24	11-882	119	12-314	156	14-030	155
10-596	148	11-127	101	11-332	116	11-601-1	24	11-883	120	12-315	156	14-031	154
10-598	148	11-128	101	11-333	116	11-604	25	11-884	120	12-316	156	14-032	154
10-599	24	11-129	101	11-334	117	11-605	25	11-885	121	12-317	156	14-034-401	155
10-600	144	11-130	102	11-335	116	11-610	128	11-890	111	12-319	156	14-035	154
10-602	149	11-131	102	11-336	116	11-611	128	11-891-1	111	12-321	156	14-036	165
10-604	149	11-132	102	11-337	117	11-612	128	11-892-1	111	12-322	156	14-037	165
10-606	149	11-135	102	11-338	113	11-614	128	11-893-1	111	12-324	156	14-038	165
10-650	167	11-136	102	11-339	118	11-617	128	11-901	108	12-350	156	14-039	153
10-651	167	11-136-150	102	11-340	118	11-690	107	11-902	108	12-600	160	14-220	164
10-700	159	11-152	125	11-341	118	11-691	107	11-903	108	12-601	160	14-502	151
10-701	159	11-153	125	11-342	118	11-710	25	11-904	108	12-602	160	14-508	153
10-702	169	11-165	126	11-343	118	11-711	25	11-905	108	12-605	160	14-510	153
10-703	169	11-167	123	11-344	118	11-712	25	11-906	108	12-606	160	14-514	154
10-704	169	11-168	123	11-345	119	11-714	26	11-907	108	12-610	160	14-550	158
10-705	169	11-169	123	11-346	119	11-716	26	11-908	108	12-611	160	14-552	165
10-706	169	11-170	121	11-347	119	11-718	26	11-909	108	12-612	160	14-570	155
10-707	169	11-171	121	11-360	94	11-719	26	11-915	108	12-613	160	14-572	155
10-708	169	11-172	105	11-361	94	11-720	23	11-920	127	12-615	160	14-610	156
10-709	169	11-190	126	11-362	94	11-730	23	11-922	127	12-616	160	14-611	156
10-710	169	11-191	126	11-363	94	11-731	23	11-923	128	12-617	160	14-612	156
10-711	169	11-192	126	11-364	94	11-732	23	11-925	127	12-618	160	14-613	156
10-712	169	11-203	120	11-365	94	11-733	23	11-931	108	12-620	160	14-614	156
10-713	169	11-204	120	11-366	94	11-737	22	11-950	136	12-621	160	14-615	156
10-714	169	11-205	120	11-367	94	11-749	25	11-952	136	12-622	160	14-620	156
10-715	169	11-218	121	11-368	94	11-750	23	11-953	136	12-623	160	14-621	156
10-800	97	11-221	122	11-369	94	11-751	23	11-956	136	12-625	160	14-622	156
10-801	97	11-222	122	11-370	94	11-760	22	11-960	136	12-626	160	14-623	156
10-802	97	11-223	122	11-371	94	11-761	22	11-961	136	12-627	160	14-624	156

Ref	p.	Ref	p.	Ref	p.	Ref	p.	Ref	p.	Ref	p.	Ref	p.
14-625	156	55-020	202	55-910	209	56-532	217	57-086	202	58-014	211	63-060	91
14-626	156	55-021	202	55-911	209	56-533	217	57-088	202	58-040	210	63-700	91
14-627	156	55-022	202	55-914	209	56-534	217	57-089	202	58-048	210	63-702	91
14-628	156	55-024	202	55-915	209	56-535	217	57-090	202	58-055	211	63-704	91
14-629	156	55-025	202	55-916	209	56-536	217	57-250	204	58-056	211	63-705	91
14-630	156	55-026	202	55-917	209	56-540	217	57-581	208	58-057	211	63-706	91
14-631	156	55-027	202	55-918	209	56-541	217	57-582	208	58-061	211	63-707	91
14-650	156	55-029	202	55-919	209	56-542	216	57-583	208	58-072	211	63-708	91
14-651	156	55-030	202	55-920	209	56-543	216	57-585	208	58G000-SET1	188	63-710	92
14-652	156	55-031	202	55-921	209	56-544	217	57-587	208	58G001-1	200	63-710	92
14-653	156	55-033	202	55-922	209	56-545	217	57-589	208	58G002-1	200	63-713	90
14-654	156	55-035	202	55-923	209	56-546	217	57-591	208	58G003	193	64-001	92
14-655	156	55-036	202	55-924	209	56-547	217	57-592	208	58G004-1	200	64-010	92
14-656	156	55-038	202	55-925	209	56-554	215	57-596	208	58G007	197	64-013	92
14-657	156	55-039	202	55-926	209	56-555	215	57-598	208	58G010	189	64-014	92
14-658	156	55-040	202	55-927	209	56-556	215	57-599	208	58G012	191	64-015	92
14-699	164	55-224	218	55-928	206	56-557	215	57-600	208	58G013	194	64-020	92
14-700	163	55-320	204	55-929	206	56-558	215	57-601	208	58G017	197	64-220	92
14-702	163	55-350	205	55-932	218	56-560	217	57-602	208	58G018	192	64-420	92
14-703	163	55-351	205	55-933	207	56-562	217	57-700	203	58G019	189	64-620	92
14-704	163	55-352	205	55-934	207	56-604	218	57-705	203	58G020	188	75-000	133
14-706	164	55-353	205	55-935	207	56-606	218	57-719	203	58G020-SET2	188	75-001	133
14-708	165	55-354	205	55-936	207	56-610	218	57-739	203	58G022	189	75-011	133
14-710	165	55-355	205	55-937	207	56-612	218	57-740	203	58G022-AD	189	75-020	133
14-712	165	55-356	205	55-938	207	56-650	210	57-741	203	58G024	191	75-021	133
14-714-1	162	55-357	205	55-939	207	56-655	210	57-835	207	58G025	199	75-022	133
14-715	162	55-358	205	55-940	207	57-010	202	57-836	207	58G026	193	75-023	133
14-716	162	55-359	205	55-941	207	57-012	202	57-837	207	58G028-1	192	81-210-L	226
14-718	163	55-360	205	55-942	207	57-014	202	57-838	207	58G038	192	81-210-LD	226
14-719	162	55-361	205	55-943	207	57-014-10	202	57-839	207	58G040	196	81-210-M	226
14-720	164	55-362	205	55-944	207	57-015	202	57-840	207	58G041	199	81-210-S	226
14-722	164	55-363	205	55-980	207	57-016	202	57-841	207	58G082	196	81-210-XL	226
14-724	164	55-364	205	55-981	207	57-018	202	57-842	207	58G085-1	200	81-210-XXL	226
14-730	158	55-365	205	55-982	207	57-018-10	202	57-843	207	58G086-1	200	81-216-L	225
14-732	158	55-366	205	55-983	207	57-020	202	57-844	207	58G090	199	81-216-M	225
14-734	159	55-367	205	55-984	207	57-020-10	202	57-845	207	58G092	200	81-216-S	225
14-735	159	55-368	205	55-985	207	57-022	202	57-860	207	58G093	200	81-216-XL	225
14-800-1	159	55-369	205	55-986	207	57-022-10	202	57-900	204	58G097	26	81-216-XXL	225
14-802-1	159	55-370	205	55-987	207	57-023	202	57-901	204	58G722	191	81-216-XXXL	225
14-804-1	159	55-371	205	55-988	207	57-023-10	202	57-902	204	58G793	190	81-217-L	225
14-806-1	159	55-372	205	55-989	207	57-024	202	57-903	204	58G961	197	81-217-M	225
14-808-1	159	55-373	205	55-990	207	57-024-10	202	57-904	204	58G971	197	81-217-S	225
14-820	163	55-374	205	55-991	207	57-026	202	57-905	204	58GE105	26	81-217-XL	225
18-101-1	129	55-375	205	55-992	206	57-026-10	202	57-906	204	58GE109	197	81-217-XS	225
18-102-1	129	55-376	205	56-040	140	57-028	202	57-907	204	58GE114	198	81-217-XXL	225
18-103-1	129	55-377	205	56-246	204	57-028-10	202	57-908	204	58GE115	198	81-217-XXXL	225
18-106-1	129	55-570	203	56-420	211	57-030	202	57-909	204	58GE124	27	81-218-L	226
18-107	129	55-572	203	56-421	203	57-030-10	202	57-910	204	58GE128	198	81-218-M	226
19-151	132	55-574	203	56-500	215	57-032	202	57-911	204	58GE130	193	81-218-S	226
19-152	132	55-576	203	56-501	215	57-032-10	202	57-912	204	58GE131-1	200	81-218-XL	226
19-153	132	55-577	203	56-502	215	57-034	202	57-913	204	58GE132-1	200	81-218-XXL	226
19-158	132	55-578	203	56-503	215	57-034-10	202	57-914	204	58GE133	27	81-218-XXXL	226
19-159	132	55-579	203	56-504	215	57-036	202	57-915	204	58GE139	190	81-220-L	220
19-200	131	55-754	208	56-505	215	57-036-10	202	57-916	204	58GE142	193	81-220-LD	220
19-220	131	55-755	208	56-506	215	57-038	202	57-917	204	58GE143	198	81-220-M	220
19-225	131	55-756	208	56-507	215	57-038-10	202	57-918	204	58GE145	197	81-220-S	220
19-250	131	55-757	208	56-508	215	57-040	202	57-919	204	58GE146	195	81-220-XL	220
19-906	131	55-758	208	56-509	215	57-040-10	202	57-920	204	58GE152	200	81-220-XXL	220
19-907	131	55-759	208	56-510	215	57-042	202	57-922	204	59G025	194	81-226-L	220
19-908	131	55-763	209	56-511	215	57-042-10	202	57-924	204	59G063	194	81-226-M	220
20-021	130	55-764	209	56-512	215	57-044	202	57-926	204	59G087	194	81-226-S	220
20-022	130	55-765	209	56-513	215	57-046	202	57-928	204	59G175	194	81-226-XL	220
20-025	130	55-766	209	56-514	215	57-046-5	202	57-930	204	59G208	194	81-226-XS	220
20-026	130	55-767	209	56-515	215	57-048	202	57-932	204	59G348	195	81-226-XXL	220
20-030	130	55-768	209	56-516	215	57-048-5	202	57-934	204	59G383	199	81-226-XXXL	220
20-033	130	55-811	206	56-517	215	57-050	202	57-936	204	59G522	196	81-228-L	221
20-036	130	55-823	206	56-518	216	57-050-5	202	57-938	204	59G523	196	81-228-M	221
20-040	130	55-825	206	56-519	216	57-052	202	57-940	204	59G526	196	81-228-S	221
20-041	130	55-826	206	56-520	216	57-054	202	57-944	204	59G873	198	81-228-XL	221
20-045	130	55-855	207	56-521	216	57-054-5	202	57-947	210	61-001	133	81-228-XS	221
33-090	132	55-856	207	56-522	216	57-055	202	57-948	210	61-002	133	81-228-XXL	221
50-900	111	55-857	207	56-523	216	57-056	202	57-950	210	61-004	133	81-228-XXXL	221
55-010	202	55-858	207	56-524	216	57-056-5	202	57-951	210	61-005	133	81-229-L	222
55-013	202	55-859	207	56-525	216	57-058	202	57-952	210	61-006	133	81-229-M	222
55-014	202	55-904	209	56-526	216	57-058-5	202	57-953	210	63-011	90	81-229-S	222
55-015	202	55-905	209	56-527	216	57-062	202	57-954	210	63-012	91	81-229-XL	222
55-016	202	55-906	209	56-528	216	57-062-5	202	58-006	211	63-013	91	81-229-XS	222
55-017	202	55-907	209	56-529	216	57-064	202	58-010	211	63-014	90	81-229-XXL	222
55-018	202	55-908	209	56-530	217	57-066	202	58-012	211	63-021	90	81-229-XXXL	222
55-019	202	55-909	209	56-531	217	57-066-5	202	58-013	211	63-050	91	81-230-L	220

Ref	p.	Ref	p.	Ref	p.	Ref	p.	Ref	p.	Ref	p.	Ref	p.	Ref	p.
81-230-LD	220	81-280-L	233	81-298-3-XXXL	224	81-511-XXL	228	81-555-XXL	228	81-649-S	230	81-692-L	230	81-692-L	230
81-230-M	220	81-280-M	233	81-351-1-L	224	81-511-XXXL	228	81-555-XXXL	228	81-649-XL	230	81-692-M	230	81-692-M	230
81-230-S	220	81-280-S	233	81-351-1-M	224	81-513-L	233	81-556-L	227	81-649-XXL	230	81-692-S	230	81-692-S	230
81-230-XL	220	81-280-XL	233	81-351-1-S	224	81-513-M	233	81-556-M	227	81-649-XXXL	230	81-692-XL	230	81-692-XL	230
81-230-XXL	220	81-280-XXL	233	81-351-1-XL	224	81-513-S	233	81-556-S	227	81-650-L	233	81-692-XXL	230	81-692-XXL	230
81-231-L	220	81-280-XXXL	233	81-351-1-XS	224	81-513-XL	233	81-556-XL	227	81-650-M	233	81-692-XXXL	230	81-692-XXXL	230
81-231-M	220	81-282-L	233	81-351-1-XXL	224	81-513-XXL	233	81-556-XXL	227	81-650-S	233	81-900	243	81-900	243
81-231-S	220	81-282-M	233	81-351-1-XXXL	224	81-513-XXXL	233	81-556-XXXL	227	81-650-XL	233	82-010	235	82-010	235
81-231-XL	220	81-282-S	233	81-360-1-L	221	81-514-L	233	81-558-L	227	81-650-XXL	233	82-011	235	82-011	235
81-231-XS	220	81-282-XL	233	81-360-1-M	221	81-514-M	233	81-558-M	227	81-650-XXXL	233	82-012	235	82-012	235
81-231-XXL	220	81-282-XXL	233	81-360-1-S	221	81-514-S	233	81-558-S	227	81-651-L	233	82-013	235	82-013	235
81-231-XXXL	220	81-282-XXXL	233	81-360-1-XL	221	81-514-XL	233	81-558-XL	227	81-651-M	233	82-014	235	82-014	235
81-233-L	222	81-283-L	233	81-360-1-XS	221	81-514-XXL	233	81-558-XXL	227	81-651-S	233	82-015	235	82-015	235
81-233-M	222	81-283-M	233	81-360-1-XXL	221	81-514-XXXL	233	81-565-L	222	81-651-XL	233	82-016	235	82-016	235
81-233-S	222	81-283-S	233	81-360-1-XXXL	221	81-530-L	231	81-565-M	222	81-651-XXL	233	82-017	235	82-017	235
81-233-XL	222	81-283-XL	233	81-360-2-L	221	81-530-M	231	81-565-S	222	81-651-XXXL	233	82-018	235	82-018	235
81-233-XS	222	81-283-XXL	233	81-360-2-M	221	81-530-S	231	81-565-XL	222	81-659-L	230	82-020	238	82-020	238
81-233-XXL	222	81-283-XXXL	233	81-360-2-S	221	81-530-XL	231	81-565-XXL	222	81-659-M	230	82-021	238	82-021	238
81-233-XXXL	222	81-287-2-L	222	81-360-2-XL	221	81-530-XXL	231	81-565-XXXL	222	81-659-S	230	82-022	238	82-022	238
81-236-L	221	81-287-2-M	222	81-360-2-XS	221	81-532-L	231	81-606-L	230	81-659-XXL	230	82-023	238	82-023	238
81-236-M	221	81-287-2-S	222	81-360-2-XXL	221	81-532-M	231	81-606-M	230	81-659-XXL	230	82-024	238	82-024	238
81-236-S	221	81-287-2-XL	222	81-360-2-XXXL	221	81-532-S	231	81-606-S	230	81-659-XXXL	230	82-025	238	82-025	238
81-236-XL	221	81-287-2-XS	222	81-361-1-L	221	81-532-XL	231	81-606-XL	230	81-660-L/XL	234	82-026	238	82-026	238
81-236-XS	221	81-287-2-XXL	222	81-361-1-M	221	81-532-XXL	231	81-606-XXL	230	81-660-S/M	234	82-027	238	82-027	238
81-236-XXL	221	81-287-2-XXXL	222	81-361-1-S	221	81-532-XXXL	231	81-606-XXXL	230	81-660-XXL/XXXL	234	82-028	238	82-028	238
81-236-XXXL	221	81-290-L	220	81-361-1-XL	221	81-534-L	231	81-609-L	228	81-661-L/XL	234	82-089-39	237	82-089-39	237
81-238-L	222	81-290-M	220	81-361-1-XS	221	81-534-M	231	81-609-M	228	81-661-S/M	234	82-089-40	237	82-089-40	237
81-238-M	222	81-290-S	220	81-361-1-XXL	221	81-534-S	231	81-609-S	228	81-661-XXL/XXXL	234	82-089-41	237	82-089-41	237
81-238-S	222	81-290-XL	220	81-361-1-XXXL	221	81-534-XL	231	81-609-XL	228	81-662-L/XL	234	82-089-42	237	82-089-42	237
81-238-XL	222	81-290-XS	220	81-361-2-L	221	81-534-XXL	231	81-609-XXL	228	81-662-S/M	234	82-089-43	237	82-089-43	237
81-238-XS	222	81-290-XXL	220	81-361-2-M	221	81-534-XXXL	231	81-609-XXXL	228	81-662-XXL/XXXL	234	82-089-44	237	82-089-44	237
81-238-XXL	222	81-290-XXXL	220	81-361-2-S	221	81-540-L	232	81-610-L	229	81-663-L/XL	234	82-089-45	237	82-089-45	237
81-238-XXXL	222	81-295-1-L	223	81-361-2-XL	221	81-540-M	232	81-610-M	229	81-663-S/M	234	82-089-46	237	82-089-46	237
81-239-L	220	81-295-1-M	223	81-361-2-XS	221	81-540-S	232	81-610-S	229	81-663-XXL/XXXL	234	82-089-47	237	82-089-47	237
81-239-M	220	81-295-1-S	223	81-361-2-XXL	221	81-540-XL	232	81-610-XL	229	81-670-L/XL	234	82-090	235	82-090	235
81-239-S	220	81-295-1-XL	223	81-361-2-XXXL	221	81-540-XXL	232	81-610-XXL	229	81-670-S/M	234	82-091	235	82-091	235
81-239-XL	220	81-295-1-XS	223	81-420-L	222	81-541-L	232	81-615-L	230	81-670-XXL/XXXL	234	82-092	235	82-092	235
81-239-XS	220	81-295-1-XXL	223	81-420-LD	222	81-541-M	232	81-615-M	230	81-671-L/XL	234	82-093	235	82-093	235
81-239-XXL	220	81-295-1-XXXL	223	81-420-M	222	81-541-S	232	81-615-S	230	81-671-S/M	234	82-094	235	82-094	235
81-239-XXXL	220	81-295-2-L	223	81-420-S	222	81-541-XL	232	81-615-XL	230	81-671-XXL/XXXL	234	82-095	235	82-095	235
81-240-L	224	81-295-2-M	223	81-420-XL	222	81-541-XXL	232	81-615-XXL	230	81-672-L/XL	234	82-096	235	82-096	235
81-240-LD	224	81-295-2-S	223	81-420-XXL	222	81-545-L	231	81-621	235	81-672-S/M	234	82-097	235	82-097	235
81-240-M	224	81-295-2-XL	223	81-500-L	226	81-545-M	231	81-627	235	81-672-XXL/XXXL	234	82-098	235	82-098	235
81-240-S	224	81-295-2-XS	223	81-500-M	226	81-545-S	231	81-630	235	81-673-L/XL	234	82-100	236	82-100	236
81-240-XL	224	81-295-2-XXL	223	81-500-S	226	81-545-XL	231	81-631	235	81-673-S/M	234	82-101	236	82-101	236
81-240-XXL	224	81-295-2-XXXL	223	81-500-XXL	226	81-545-XXL	231	81-632	235	81-673-XXL/XXXL	234	82-102	236	82-102	236
81-246-L	224	81-296-1-L	223	81-500-XXL	226	81-545-XXXL	231	81-640-L	228	81-679-L	232	82-103	236	82-103	236
81-246-M	224	81-296-1-M	223	81-501-L	226	81-546-L	231	81-640-M	228	81-679-M	232	82-104	236	82-104	236
81-246-S	224	81-296-1-S	223	81-501-M	226	81-546-M	231	81-640-XL	228	81-679-XXL	232	82-105	236	82-105	236
81-246-XL	224	81-296-1-XL	223	81-501-S	226	81-546-S	231	81-640-XXL	228	81-679-XXL	232	82-106	236	82-106	236
81-246-XS	224	81-296-1-XS	223	81-501-XXL	226	81-546-XL	231	81-640-XXXL	228	81-680-L	229	82-107	236	82-107	236
81-246-XXL	224	81-296-1-XXL	223	81-501-XXL	226	81-546-XXL	231	81-641-L	228	81-680-M	229	82-108	236	82-108	236
81-246-XXXL	224	81-296-1-XXXL	223	81-502-L	227	81-546-XXXL	231	81-641-M	228	81-680-S	229	82-110	236	82-110	236
81-248-L	224	81-296-3-L	223	81-502-M	227	81-547-L	231	81-641-XXL	228	81-680-XL	229	82-111	236	82-111	236
81-248-M	224	81-296-3-M	223	81-502-S	227	81-547-M	231	81-641-XXL	228	81-680-XXL	229	82-112	236	82-112	236
81-248-S	224	81-296-3-S	223	81-502-XL	227	81-547-S	231	81-641-XXXL	228	81-680-XXXL	229	82-113	236	82-113	236
81-248-XL	224	81-296-3-XL	223	81-502-XXL	227	81-547-XL	231	81-642-L	228	81-681-L	229	82-114	236	82-114	236
81-248-XS	224	81-296-3-XS	223	81-502-XXXL	227	81-547-XXL	231	81-642-M	228	81-681-M	229	82-115	236	82-115	236
81-248-XXL	224	81-296-3-XXL	223	81-503-L	227	81-547-XXXL	231	81-642-XL	228	81-681-S	229	82-116	236	82-116	236
81-248-XXXL	224	81-296-3-XXXL	223	81-503-M	227	81-549-L	232	81-642-XXL	228	81-681-XXL	229	82-117	236	82-117	236
81-250-L	225	81-298-1-L	223	81-503-S	227	81-549-M	232	81-642-XXXL	228	81-681-XXL	229	82-118	236	82-118	236
81-250-LD	225	81-298-1-M	223	81-503-XL	227	81-549-S	232	81-643-L	229	81-681-XXXL	229	82-120	237	82-120	237
81-250-M	225	81-298-1-S	223	81-503-XXL	227	81-549-XL	232	81-643-M	229	81-682-L	229	82-121	237	82-121	237
81-250-S	225	81-298-1-XL	223	81-503-XXXL	227	81-549-XXL	232	81-643-XXL	229	81-682-M	229	82-122	237	82-122	237
81-250-XL	225	81-298-1-XS	223	81-506-L	226	81-549-XXXL	232	81-643-XXL	229	81-682-S	229	82-123	237	82-123	237
81-250-XXL	225	81-298-1-XXL	223	81-506-M	226	81-550-L	227	81-643-XXXL	229	81-682-XL	229	82-124	237	82-124	237
81-258-L	225	81-298-1-XXXL	223	81-506-S	226	81-550-M	227	81-647-L	229	81-682-XXL	229	82-125	237	82-125	237
81-258-M	225	81-298-2-L	223	81-506-XL	226	81-550-S	227	81-647-M	229	81-682-XXXL	229	82-126	237	82-126	237
81-258-S	225	81-298-2-M	223	81-506-XXL	226	81-550-XL	227	81-647-S	229	81-690-L	230	82-127	237	82-127	237
81-258-XL	225	81-298-2-S	223	81-506-XXXL	226	81-550-XXL	227	81-647-XL	229	81-690-M	230	82-128	237	82-128	237
81-258-XS	225	81-298-2-XL	223	81-507-L	226	81-551-L	227	81-647-XXL	229	81-690-S	230	82-155-39	235	82-155-39	235
81-258-XXL	225	81-298-2-XS</													

Ref	p.	Ref	p.	Ref	p.	Ref	p.	Ref	p.	Ref	p.	Ref	p.
82-160-40	235	82-360	239	84-118	17	84-402	21	90-184	109	97-640-10	239	99-102	181
82-160-41	235	82-361	239	84-119	17	84-403	21	90-185	109	97-641-8	239	99-107	179
82-160-42	235	82-365	239	84-130	17	84-404	14	97-300	242	97-641-9	239	99-109	179
82-160-43	235	82-366	239	84-140	22	84-405	21	97-301	242	97-641-10	239	99-112	179
82-160-44	235	82-700	236	84-141	22	84-500	20	97-311	242	97-642-8	239	99-114	181
82-160-45	235	82-701	236	84-142	21	84-502	20	97-321	242	97-642-9	239	99-115	179
82-160-46	235	82-702	236	84-143	21	84-503	20	97-350	243	97-642-10	239	99-117	178
82-160-47	235	82-703	236	84-199	14	90-001	245	97-351	242	97-643-8	239	99-121	183
82-161-39	236	82-704	236	84-214	13	90-002	245	97-352	242	97-643-9	239	99-124	184
82-161-40	236	82-705	236	84-214-6	31	90-003	245	97-353	242	97-643-10	239	99-125	183
82-161-41	236	82-706	236	84-220	13	90-009	245	97-360	243	97-690-L	241	99-126	183
82-161-42	236	82-707	236	84-220-6	29	90-010	245	97-361	243	97-690-M	241	99-128	181
82-161-43	236	82-708	236	84-221	13	90-011	246	97-362	243	97-690-XL	241	99-130	183
82-161-44	236	82-710	236	84-221-9	30	90-012	246	97-363	243	97-691-L	241	99-200	179
82-161-45	236	82-711	236	84-222	13	90-015	245	97-390	242	97-691-M	241	99-201	179
82-161-46	236	82-712	236	84-222-9	30	90-016	246	97-391	242	97-691-XL	241	GD04	173
82-161-47	236	82-713	236	84-222-12	30	90-017	246	97-500	241	99-026	178	GD05	173
82-162-39	237	82-714	236	84-225	13	90-030	246	97-501	241	99-027	177	GD07	173
82-162-40	237	82-715	236	84-225-6	29	90-032	247	97-510	241	99-028	177	GD08	172
82-162-41	237	82-716	236	84-229	14	90-033	248	97-513	241	99-029	178	GD09	172
82-162-42	237	82-717	236	84-230	31	90-034	247	97-530	244	99-032	177	GD010	173
82-162-43	237	82-718	236	84-231	32	90-035	247	97-535	243	99-033	176	GD012	241
82-162-44	237	82-720	237	84-232	32	90-037	247	97-536	243	99-034	176	GD013	241
82-162-45	237	82-721	237	84-233	33	90-039	246	97-550	244	99-035	176	GD014	241
82-162-46	237	82-722	237	84-234	33	90-060	248	97-552	244	99-037	176	GD015	173
82-162-47	237	82-723	237	84-235	33	90-061	248	97-553	244	99-038	182	GD016	172
82-163-39	236	82-724	237	84-236	33	90-062	248	97-554	244	99-040	182	GD017	238
82-163-40	236	82-725	237	84-237	32	90-063	248	97-555	244	99-041	180	GD018	238
82-163-41	236	82-726	237	84-238	32	90-064	248	97-590	243	99-042	180	GD019	238
82-163-42	236	82-727	237	84-239	32	90-065	248	97-602	240	99-043	180	GD020	238
82-163-43	236	82-728	237	84-240	31	90-066	248	97-603	240	99-044	180	GD021	173
82-163-44	236	82-741-39	237	84-241	33	90-067	248	97-604	240	99-045	177	GD024	172
82-163-45	236	82-741-40	237	84-242	31	90-068	248	97-605	240	99-047	181	GD027	172
82-163-46	236	82-741-41	237	84-243	33	90-069	248	97-606	240	99-048	181	GD028	172
82-163-47	236	82-741-42	237	84-244	31	90-080	249	97-609-8	240	99-049	185	GD029	172
82-165-39	238	82-741-43	237	84-246	34	90-081	249	97-609-9	240	99-050	185	GD030	238
82-165-40	238	82-741-44	237	84-247	32	90-082	249	97-609-10	240	99-051	185	GD031	238
82-165-41	238	82-741-45	237	84-249	34	90-083	249	97-610-8	240	99-052	185	GD032	238
82-165-42	238	82-741-46	237	84-254	34	90-084	249	97-610-9	240	99-053	185	GD033	238
82-165-43	238	82-741-47	237	84-255	16	90-085	249	97-610-10	240	99-054	185		
82-165-44	238	82-751-39	237	84-256	16	90-086	249	97-612-8	240	99-059	186		
82-165-45	238	82-751-40	237	84-257	16	90-110	248	97-612-9	240	99-060	186		
82-165-46	238	82-751-41	237	84-264	34	90-111	247	97-612-10	240	99-061	186		
82-165-47	238	82-751-42	237	84-266	16	90-112	247	97-616-8	239	99-062	186		
82-166-39	238	82-751-43	237	84-268	16	90-113	247	97-616-9	239	99-063	185		
82-166-40	238	82-751-44	237	84-271	14	90-114	247	97-616-10	239	99-064	182		
82-166-41	238	82-751-45	237	84-274	14	90-118	250	97-617-8	239	99-065	180		
82-166-42	238	82-751-46	237	84-300	19	90-119	250	97-617-9	239	99-066	181		
82-166-43	238	82-751-47	237	84-301	19	90-133	250	97-617-10	239	99-067	177		
82-166-44	238	83S217-L	241	84-302	18	90-134	250	97-620-8	240	99-069	178		
82-166-45	238	83S217-XL	241	84-303	18	90-170	109	97-620-9	240	99-070	176		
82-166-46	238	84-092	15	84-304	18	90-171	109	97-620-10	240	99-071	180		
82-166-47	238	84-093	15	84-305	19	90-172	109	97-621-8	240	99-072	180		
82-315	238	84-094	15	84-306	18	90-173	109	97-621-9	240	99-073	178		
82-316	238	84-095	15	84-308	19	90-174	109	97-621-10	240	99-075	177		
82-325	238	84-096	15	84-311	18	90-175	109	97-622-8	240	99-076	182		
82-326	238	84-097	15	84-315	19	90-176	109	97-622-9	240	99-077	182		
82-327	238	84-098	15	84-330	19	90-177	109	97-622-10	240	99-093	185		
82-328	238	84-100	15	84-332	20	90-178	109	97-622-10	240	99-095	186		
82-329	238	84-101	15	84-333	20	90-179	109	97-631-8	240	99-096	186		
82-350	239	84-102	15	84-334	20	90-180	109	97-631-9	240	99-097	178		
82-351	239	84-105	15	84-335	20	90-181	109	97-631-10	240	99-098	184		
82-355	239	84-114	15	84-350	16	90-182	109	97-640-8	239	99-099	184		
82-356	239	84-115	17	84-401	21	90-183	109	97-640-9	239	99-101	176		

GTX Poland nie ponosi żadnej odpowiedzialności za możliwe błędy w katalogach, broszurach i innych materiałach drukowanych. GTX Poland zastrzega sobie prawo do dokonywania zmian w produktach bez uprzedzenia. Dotyczy to również produktów już zamówionych. Zamienne mogą być dostarczone bez dokonywania jakichkolwiek zmian w specyfikacjach już uzgodnionych. Wszystkie znaki towarowe w tym materiale są własnością odpowiednich firm. Znaki towarowe GRAPHITE, NEO są własnością "GTX Poland Sp. z o.o." Sp.k. Niniejszy katalog ma jedynie charakter informacyjny i nie stanowi oferty zawarcia umowy. Zdjęcia umieszczone w katalogu są zdjęciami poglądowymi i produkty w rzeczywistości mogą się nieznacznie różnić od zamieszczonych ilustracji. Publikacja chroniona prawem autorskim. Kopiowanie, przedrukowywanie i rozpowszechnianie całości lub fragmentów, również na nośnikach magnetycznych lub elektronicznych bez zgody firmy GTX Poland jest zabronione.

GTX Poland shall not be held liable for any errors in catalogues, brochures and other printed materials. GTX Poland stipulates the right to modify the products without prior notice. This shall also apply to products already ordered. Replacements may be delivered without any modifications of specifications already agreed upon. All trademarks, inclusive of those contained in this material, are the property of relevant companies. GRAPHITE, NEO trademarks are the property of "GTX Poland Sp. z o.o." Sp.k. Limited Partnership. This catalogue is intended for informational purposes only and is not a binding offer for agreement. Pictures in the catalogue are for illustration purposes, real products may slightly vary from provided illustrations. Publication protected under copyright law. Copying, reprinting and distribution of the entirety or parts thereof, inclusive of on magnetic and electronic media, without the consent of GTX Poland shall be prohibited.



NEO
TOOLS

GRAPHITE